



NEHRP Recommended Seismic Provisions for New Buildings and Other Structures

Volume I: Part 1 Provisions, Part 2 Commentary

FEMA P-2082-1 / September 2020



FEMA



Veterans Administration Puget Sound Mental Health and Research Building located in Seattle, Washington and opened in 2019. The six-story buckling-restrained steel braced frame was designed as a Risk Category IV structure.

Credit: © Benjamin Benschneider. Used with permission.

NEHRP (National Earthquake Hazards Reduction Program)

Recommended Seismic Provisions

for New Buildings and Other Structures (FEMA P-2082-1)

2020 Edition

Volume I: Part 1 Provisions and Part 2 Commentary

Prepared for the Federal Emergency Management Agency of the
U.S. Department of Homeland Security
By the Building Seismic Safety Council of the
National Institute of Building Sciences

BUILDING SEISMIC SAFETY COUNCIL
A council of the National Institute of Building Sciences
Washington, D.C.
2020

NOTICE: Any opinions, findings, conclusions, or recommendations expressed in this publication do not necessarily reflect the views of the Federal Emergency Management Agency. Additionally, neither FEMA nor any of its employees make any warranty, expressed or implied, nor assume any legal liability or responsibility for the accuracy, completeness, or usefulness of any information, product, or process included in this publication.

The National Institute of Building Sciences (NIBS) brings together members of the building industry, labor and consumer interests, government representatives, and regulatory agencies to identify and resolve problems and potential problems around the construction of housing and commercial buildings. NIBS is a nonprofit, non-governmental organization established by Congress in 1974.

The **Building Seismic Safety Council** (BSSC) was established in 1979 under the auspices of NIBS as a forum-based mechanism for dealing with the complex regulatory, technical, social, and economic issues involved in developing and promulgating building earthquake hazard mitigation regulatory provisions that are national in scope. By bringing together in the BSSC all of the needed expertise and all relevant public and private interests, it was believed that issues related to the seismic safety of the built environment could be resolved and jurisdictional problems overcome through authoritative guidance and assistance backed by a broad consensus.

The BSSC is an independent, voluntary membership body representing a wide variety of building community interests. Its fundamental purpose is to enhance public safety by providing a national forum that fosters improved seismic safety provisions for use by the building community in the planning, design, construction, regulation, and utilization of buildings.

This report was prepared under Contract HSFE60-15-D-0022 between the Federal Emergency Management Agency and the National Institute of Building Sciences.

For further information on Building Seismic Safety Council activities and products, see the Council's website (<https://www.nibs.org/page/bssc>) or contact the Building Seismic Safety Council, National Institute of Building Sciences, 1090 Vermont Avenue, N.W., Suite 700, Washington, D.C. 20005; phone 202-289-7800; e-mail nibs@nibs.org.

This FEMA resource document can be obtained from the FEMA Publications Warehouse at 1-800-480-2520 and FEMApubs@gpo.gov or through the FEMA online library: <https://www.fema.gov/emergency-managers/risk-management/building-science/earthquakes>. The report can also be downloaded in pdf form from the BSSC website at <https://www.nibs.org/page/bssc>.

The National Institute of Building Sciences and its Building Seismic Safety Council caution users of this Provisions document to be alert to patent and copyright concerns especially when applying prescriptive requirements.

FOREWORD

The National Earthquake Hazards Reduction Program (NEHRP) Recommended Seismic Provisions for New Buildings and Other Structures is a well-known technical resource document for improving national seismic design standards and model building codes. Each edition of the *NEHRP Provisions* has been developed based on the most recent advancements in earthquake engineering and research. The 2020 *NEHRP Provisions* continues to apply the current state-of-knowledge in earthquake engineering for improving the seismic design of buildings and other structures. It presents a set of recommended improvements to the ASCE/SEI 7-16 Standard: Minimum Design Loads and Associated Criteria for Buildings and Other Structures, and nine resource papers on new concepts, suggested future development, and technical information in support of the recommended improvements. The *NEHRP Provisions* is developed and evaluated through an expert-based consensus process to ensure validity and quality of the recommended new changes. It is intended primarily for use by national standards and code organizations and earthquake engineering professionals.

The *NEHRP Provisions* is intended to support strong seismic standards and codes to bolster earthquake resilience in the nation. It has been widely recognized that code conforming new buildings increase earthquake resilience for at-risk communities. When adopting and enforcing the most recent national standards and model building codes for improving earthquake resilience, local communities expect the standards and codes to be updated and equipped with the best available new earthquake knowledge and matured technologies.

The Federal Emergency Management Agency (FEMA) shares a responsibility with other NEHRP agencies under the NEHRP Reauthorization Act (P.L. 115-307) “to use research results ... support model codes that are cost effective and affordable in order to promote better practices within the design and construction industry and reduce losses from earthquakes.” Consistent with this objective, FEMA is proud to support the development of the tenth edition of the *NEHRP Provisions*, which has broadly reviewed and translated many recent NEHRP and private sector research results into codifiable seismic design requirements and guidelines.

FEMA is grateful to the large number of experts serving on the 2020 Provisions Update Committee, Issue Teams, Project 17 Committee and its Work Groups, the member organizations of Building Seismic Safety Council (BSSC) of National Institute of Building Sciences, the BSSC Board of Direction and project managers, and NEHRP agency representatives whose dedicated and persistent efforts make the 2020 *NEHRP Provisions* a great success. Americans unfortunate enough to experience the earthquakes that will inevitably occur in this country in the future will owe much, perhaps even their very lives, to the contributions and dedication of these individuals for the seismic safety of buildings and other structures. Without the dedication and hard work of these men and women, this document and all it represents with respect to earthquake risk mitigation would not have been possible.

Federal Emergency Management Agency

Page intentionally left blank.

PREFACE and ACKNOWLEDGEMENTS

The 2020 *NEHRP Recommended Seismic Provisions for New Buildings and Other Structures (NEHRP Provisions)* marks the 10th edition of this landmark publication since the creation of the National Earthquake Hazards Reduction Program (NEHRP) in 1979. The *NEHRP Provisions* has become such a well-known brand name in earthquake engineering and seismic code development and has widespread influence. The Building Seismic Safety Council (BSSC) is proud to have been selected by the Federal Emergency Management Agency (FEMA) once again to play a role under NEHRP in improving the seismic resistance of the built environment. Similar to earlier editions, the 2020 *NEHRP Provisions* introduces major recommended changes and advancements to the national standards and model building codes.

The 2020 *NEHRP Provisions* development started in 2015 when the National Institute of Building Sciences, the BSSC parent organization, entered into a contract with FEMA. In early 2015, based on issues recommended for further study identified in the 2015 NEHRP Provisions Update cycle, and the assessment of recent research results and the emergence of new technologies, key areas of focus for the 2020 NEHRP Provisions Update cycle were identified. The BSSC Provisions Update Committee (PUC) was assembled with national subject matter experts based on specialty and needs, followed by ten Issue Teams with assigned specific topics to develop code change proposals. At the start of the 2020 NEHRP Provisions Update cycle, a special joint FEMA/USGS/BSSC Project 17 Committee was also formed with support of five Work Groups. The Project 17 Committee was tasked with formulating recommendations for the rules by which the new seismic design value maps for the 2020 *NEHRP Provisions* are developed. Over 130 subject matter experts were involved in the 2020 *NEHRP Provisions* development, including structural engineers, seismologists and geotechnical engineers, construction trade associations, building industry associations, building officials and others. A group of 37 BSSC Member Organizations, representing building owners, construction materials industries, earthquake research institutes, architects, and government agencies, as well as engineering associations, also participated in the vetting and approval process. This inclusive, rigorous, and national process is a key consensus platform of BSSC and is critical to the successful development of the *NEHRP Provisions*.

As chair of the BSSC Board of Direction, and as a practicing engineer for over four decades, I wish to express my appreciation of FEMA and the other NEHRP agencies for their continuous support of this important effort which allows for continuous advancements in mitigating seismic risk. It is my pleasure to express heartfelt appreciation for the over 130 dedicated volunteers who participated in the update process. The American people benefit immeasurably from their commitment to improving the seismic resistance of the nation's buildings and affording protection of lives.

With so many volunteers participating, it is difficult to single out a given number or group for special recognition without inadvertently omitting others without whose assistance the BSSC program could not have succeeded; nevertheless, the 2020 *NEHRP Provisions* would not be complete without at least recognizing the following individuals to whom I, acting on behalf of the BSSC Board of Direction, heartily express sincere appreciation:

- The members of the BSSC Provisions Update Committee, especially Chairman David Bonneville
- The members of the BSSC Project 17 Committee on Seismic Design Value Maps, especially Chairman Ronald Hamburger
- The members of the ten PUC Issue Teams and contributors to the nine resource papers
- Charles Kircher, Nicolas Luco, and Sanaz Rezaeian for developing the multi-period response spectra

- Kelly Cobeen for evaluating and updating diaphragm provisions and Satyendra K. Ghosh for introducing new coupled shear wall systems
- John Gillengerten and Bret Lizundia for introducing the new design force formula for non-structural components
- FEMA Project Officer Mai Tong and FEMA Technical Advisor Robert Hanson for project oversight and guidance

Appreciation also is due to the BSSC Executive Directors Jiqiu Yuan and Philip Schneider (retired 2019), who work untiringly behind the scenes to support all the groups mentioned above and who bring the finished product forward for acceptance. Finally, I wish to express my personal gratitude to the members of the BSSC Board of Direction and to all those who provided advice, counsel, and encouragement during conduct of the update effort.

We are proud of the 2020 *NEHRP Recommended Seismic Provisions*, and it is my pleasure to introduce it.

James R. Cagley, P.E., S.E.
Chair, BSSC Board of Direction
June, 2020

Guide to Using the 2020 NEHRP Provisions

Part 1 of the Provisions provides recommended changes to the seismic requirements of ASCE 7-16, Chapters 11 to 22. For a given chapter, only those sections with recommended modifications or additions are shown. Therefore, the Provisions Part 1 should be used side-by-side with ASCE 7-16 in order to grasp the full context of each chapter.

Part 2 of the Provisions provides a complete commentary for each chapter. It is comprised of the new commentary to each proposed change contained in Part 1 along with the existing ASCE 7-16 commentary to unchanged sections. Therefore, the Part 2 Commentary is self-contained. Black bars in the columns indicate new commentary matching Provisions Part 1 changes.

Part 3 provides resource papers adopted in the 2020 Provisions cycle. These resource papers are self-contained and not necessarily directly associated with a Part 1 provision. They are not written in standards language format.

The table in the Introduction provides a summary of Part 1 topics along with reference sections in Parts 1 and 2, and any relevant resource paper in Part 3.

CONTENTS

FOREWORD	VI
PREFACE AND ACKNOWLEDGEMENTS	VIII
INTRODUCTION	XXX
INTENT	1
1.1 INTENT	1
1.1.1 Structure Collapse	1
1.1.2 Nonstructural Damage	3
1.1.3 Hazardous Materials.....	3
1.1.4 Preservation of Egress.....	3
1.1.5 Functionality of Critical or Essential Facilities	3
1.1.6 Repair Costs	4
2.1 COMMENTARY TO THE INTENT	4
2.1.1 Structure Collapse	5
2.1.2 Nonstructural Damage	6
2.1.3 Hazardous Materials.....	7
2.1.4 Preservation of Egress.....	7
2.1.5 Functionality of Critical or Essential Facilities	7
2.1.6 Repair Costs	8
REFERENCES	9
REFERENCE DOCUMENT	10
PART 1, PROVISIONS	11
CHAPTER 11, SEISMIC DESIGN CRITERIA	12
SECTION 11.2 DEFINITIONS	12
SECTION 11.3 SYMBOLS	13
SECTION 11.4 SEISMIC GROUND MOTION VALUES	15
11.4.1 Near-fault sites	15
11.4.2 Site Class.....	15
11.4.2.1 Default Site Class	15
11.4.3 Risk-Targeted Maximum Considered Earthquake (MCE _R) Spectral Response Acceleration Parameters.....	15
11.4.4 Design Spectral Acceleration Parameters	15
11.4.5 Design Response Spectrum.....	16
11.4.5.1 Multi-Period Design Response Spectrum.....	16
11.4.5.2 Two-Period Design Response Spectrum.....	16
11.4.6 Risk-Targeted Maximum Considered Earthquake (MCE _R) Response Spectrum.....	17
11.4.7 Site-Specific Ground Motion Procedures.....	18
SECTION 11.5 IMPORTANCE FACTOR AND RISK CATEGORY	18
11.5.1 Importance Factor	18
11.5.2 Protected Access for Risk Category IV.....	18
SECTION 11.6 SEISMIC DESIGN CATEGORY	18
SECTION 11.7 DESIGN REQUIREMENTS FOR SEISMIC DESIGN CATEGORY A	20

SECTION 11.8 GEOLOGIC HAZARDS AND GEOTECHNICAL INVESTIGATION	20
11.8.1 Site Limitation for Seismic Design Categories E and F	20
11.8.2 Geotechnical Investigation Report Requirements for Seismic Design Categories C through F	20
11.8.3 Additional Geotechnical Investigation Report Requirements for Seismic Design Categories D through F	20
SECTION 11.9 VERTICAL GROUND MOTIONS FOR SEISMIC DESIGN	21
11.9.1 General	21
11.9.2 MCE_R Vertical Response Spectrum	21
11.9.3 Design Vertical Response Spectrum	22
CHAPTER 12, SEISMIC DESIGN REQUIREMENTS FOR BUILDING STRUCTURES	24
SECTION 12.2.1 SEISMIC FORCE-RESISTING SYSTEM SELECTION AND LIMITATIONS	24
12.2.1.1 Alternative Seismic Force-Resisting Systems	25
12.2.1.2 Elements of Seismic Force-Resisting Systems	25
SECTION 12.2.3.2 TWO-STAGE ANALYSIS PROCEDURE	26
12.2.3.2.1 Vertical Combinations of Systems	26
12.2.3.2.2 One-Story Structures with Flexible Diaphragms and Rigid Vertical Elements	26
SECTION 12.2.5 SYSTEM-SPECIFIC REQUIREMENTS	27
12.2.5.4 Increased Structural Height Limit for Steel Eccentrically Braced Frames, Steel Special Concentrically Braced Frames, Steel Buckling-Restrained Braced Frames, Steel Special Plate Shear Walls, Steel and Concrete Coupled Composite Plate Shear Walls, Reinforced Concrete Ductile Coupled Walls, and Special Reinforced Concrete Shear Walls	27
SECTION 12.3.2 IRREGULAR AND REGULAR CLASSIFICATION	27
12.3.2.2 Vertical Irregularity	27
SECTION 12.3.3 LIMITATIONS AND ADDITIONAL REQUIREMENTS FOR SYSTEMS WITH STRUCTURAL IRREGULARITIES	30
12.3.3.1 Prohibited Vertical Irregularities for Seismic Design Categories D through F	30
12.3.3.2 Extreme Weak Stories	30
12.3.3.3 Elements Supporting Discontinuous Walls or Frames	30
12.3.3.4 Increase in Forces Caused by Irregularities for Seismic Design Categories D through F	30
SECTION 12.3.4 REDUNDANCY	30
12.3.4.1 Conditions Where Value of ρ is 1.0.	31
12.3.4.2 Redundancy Factor, ρ , for Seismic Design Categories D through F	31
SECTION 12.5.3 SEISMIC DESIGN CATEFORY C	31
12.5.3.1 Structures with Horizontal Structural Irregularities	31
SECTION 12.6 ANALYSIS PRODECURE SELECTION	32
SECTION 12.7.3 STRUCTURAL MODELING	32
SECTION 12.8.6 DISPLACEMENT AND DRIFT DETERMINATION	32
12.8.6.1 Minimum Base Shear for Computing Displacement and Drift	32
12.8.6.2 Period for Computing Displacement and Drift	32
12.8.6.3 Design Earthquake and Maximum Considered Earthquake Displacement	32
12.8.6.4 Design Story Drift Determination	33
SECTION 12.9.1.4.2 SCALING OF DISPLACEMENTS AND DRIFTS	33
SECTION 12.10 DIAPHRAGMS, CHORDS AND COLLECTORS	33
12.10.4 Alternative Diaphragm Design Provisions for One-Story Structures with Flexible Diaphragms and Rigid Vertical Elements	34

12.10.4.1	Limitations.....	34
12.10.4.2	Design.....	35
12.10.4.2.1	Seismic Design Forces.....	35
12.10.4.2.2	Diaphragm Shears.....	36
12.10.4.2.3	Diaphragm Chords.....	36
12.10.4.2.4	Collector Elements and Their Connections.....	36
12.10.4.2.5	Diaphragm Deflection.....	36
SECTION 12.12 DRIFT AND DEFORMATION.....		37
12.12.1	Story Drift Limit.....	37
12.12.2	Structural Separation.....	37
12.12.3	Members Spanning between Structures.....	38
12.12.4	Deformation Compatibility for Seismic Design Categories D through F.....	38
SECTION 12.14 SIMPLIFIED ALTERNATIVE STRUCTURAL DESIGN CRITERIA FOR SIMPLE BEARING WALL OR BUILDING FRAME SYSTEMS.....		38
CHAPTER 13, SEISMIC DESIGN REQUIREMENTS FOR NONSTRUCTURAL COMPONENTS		40
SECTION 13.1 SCOPE.....		40
13.1.1	Scope.....	40
13.1.2	Seismic Design Category.....	40
13.1.3	Component Importance Factor.....	40
13.1.6	Application of Nonstructural Component Requirements to Nonbuilding Structures....	40
SECTION 13.2.2 SPECIAL CERTIFICATION REQUIREMENTS FOR DESIGNATED SEISMIC SYSTEMS.....		41
SECTION 13.2.8 SUPPORTED NONSTRUCTURAL COMPONENTS WITH GREATER THAN OR EQUAL TO 20% COMBINED WEIGHT.....		41
SECTION 13.3.1 SEISMIC DESIGN FORCES.....		41
13.3.1.1	Amplification with Height, H_f	42
13.3.1.2	Structure Ductility Reduction Factor, R_μ	43
13.3.1.3	Component Resonance Ductility Factor, C_{AR}	44
13.3.1.4	Component Strength, R_{po}	44
13.3.1.5	Nonlinear Response History Analysis.....	44
13.3.1.6	Vertical Force.....	44
13.3.1.7	Nonseismic Loads.....	45
SECTION 13.3.2 SEISMIC RELATIVE DISPLACEMENTS.....		45
13.3.2.1	Displacements within Structures.....	45
13.3.2.2	Displacements between Structures.....	45
SECTION 13.4 NONSTRUCTURAL COMPONENT ANCHORAGE AND ATTACHMENT.....		46
13.4.1	Design Force in the Attachment.....	46
13.4.2	Anchors in Concrete or Masonry.....	46
13.4.2.1	Anchors in Concrete.....	46
13.4.2.2	Anchors in Masonry.....	46
SECTION 13.5.3 EXTERIOR NONSTRUCTURAL WALL ELEMENTS AND CONNECTIONS.....		46
SECTION 13.5.10 EGRESS STAIRS AND RAMPS.....		47
SECTION 13.5.11 PENTHOUSES AND ROOFTOP STRUCTURES.....		47
13.5.11.1	Seismic Force-Resisting Systems for Penthouses and Rooftop Structures.....	47
SECTION 13.6.2.1 HVACR EQUIPMENT.....		49
13.6.2.1	HVACR Equipment.....	49
SECTION 13.6.4 COMPONENT SUPPORTS.....		49
13.6.4.1	Design Basis.....	49

13.6.4.6	Equipment Platforms and Support Structures	49
13.6.4.7	Distribution System Supports.....	50

CHAPTER 14, MATERIAL SPECIFIC SEISMIC DESIGN AND DETAILING REQUIREMENTS 54

SECTION 14.1.5	COLD-FIRMED STEEL DECK DIAPHRAGMS.....	54
14.1.5.1	Modifications to AISI S400	54
14.1.5.1.1	AISI S400, Section A2.1.....	54
14.1.5.1.2	AISI S400, Section A5	55
14.1.5.1.3	AISI S400, Section F1.2	55
14.1.5.1.4	AISI S400, Section F1.4.1.2	55
14.1.5.1.5	AISI S400, Section F3:	55
SECTION 14.3.3	SEISMIC REQUIREMENTS FOR COMPOSITE STEEL AND CONCRETE STRUCTURES.....	58
SECTION 14.3.5	SEISMIC REQUIREMENTS FOR COUPLED COMPOSITE PLATE SHEAR WALLS – CONCRETE FILLED (CC-PSW/CF)	59
14.3.5.1	General	59
14.3.5.1.1	Scope	59
14.3.5.1.2	Notation	59
14.3.5.1.3	Glossary	59
14.3.5.2	Basics of Design.....	60
14.3.5.3	Analysis.....	60
14.3.5.3.1	Stiffness	60
14.3.5.3.2	Required Strength for Coupling Beams	60
14.3.5.3.3	Required Strength for Composite Walls	61
14.3.5.3.4	Capacity-Limited Seismic Load	61
14.3.5.4	Composite Wall Requirements.....	61
14.3.5.4.1	Minimum Area of Steel	61
14.3.5.4.2	Steel Plate Slenderness Requirement for Composite Walls.....	61
14.3.5.4.4	Tie-to-Plate Connection.....	62
14.3.5.5	Composite Coupling Beam Requirements	62
14.3.5.5.1	Minimum Area of Steel	62
14.3.5.5.2	Slenderness Requirement for Coupling Beams	62
14.3.5.5.3	Flexure-Critical Coupling Beams	62
14.3.5.6	Composite Wall Strength	63
14.3.5.6.1	Tensile Strength.....	63
14.3.5.6.2	Comprehensive Strength.....	63
14.3.5.6.3	Flexural Strength	63
14.3.5.6.4	Combined Axial Force and Flexure	63
14.3.5.6.5	Shear Strength.....	63
14.3.5.7	Composite Coupling Beam Strength.....	64
14.3.5.7.1	Flexible Strength.....	64
14.3.5.7.2	Shear Strength.....	64
14.3.5.8	Coupling Beam-to-Wall Connections	64
14.3.5.8.1	Required Flexular Strength.....	64
14.3.5.8.2	Required Shear Strength.....	64
14.3.5.8.3	Rotation Capacity	65
14.3.5.9	Composite Wall-to-Foundation Connections	65
14.3.5.9.1	Required Strengths.....	65
14.3.5.10	Protected Zones.....	65
14.3.5.11	Demand Critical Welds in Connections	65
SECTION 14.5.2	SEISMIC REQUIREMENTS FOR CROSS LAMINATED TIMBER SHEAR WALLS	66
14.5.2.1	Scope.....	66
14.5.2.1.1	Notation	66

14.5.2.1.2	Terminology	66
14.5.2.2	Application Requirements.....	67
14.5.2.3	CLT Shear Wall Requirements	68
14.5.2.3.1	CLT panels	68
14.5.2.3.2	Top- and bottom-of-wall angle connector	68
14.5.2.3.3	Adjoining panel edge connector	69
14.5.2.3.4	Hold-down system.....	70
14.5.2.3.5	Compression zone.....	70
14.5.2.3.6	Other load path connections to CLT wall panels.....	70
14.5.2.3.7	CLT shear walls with shear resistance provided by high aspect ratio panels only.....	71
14.5.2.4	Deflection.....	71
14.5.2.5	Nominal unit shear capacity	71
14.5.2.6	ASD and LRFD design unit shear capacities	72
14.5.2.7	Diaphragm Requirements.....	72
CHAPTER 15, SEISMIC DESIGN REQUIREMENTS FOR NONBUILDING STRUCTURES.....		74
SECTION 15.2 NONBUILDING STRUCTURES CONNECTED BY NONSTRUCTURAL COMPONENTS TO OTHER ADJACENT STRUCTURES		74
15.2.1	Nonbuilding Structures Connected by Nonstructural Components to Other Adjacent Structures	74
15.2.2	Architectural, Mechanical, and Electrical Components Spanning Between Nonbuilding Structures	74
SECTION 15.3 NONBUILDING STRUCTURES SUPPORTED BY OTHER STRUCTURES		74
15.3.1	Less Than 20% Combined Weight Condition.....	74
15.3.2	Supported Nonbuilding Structures with Greater Than or Equal to 20% Combined Weight.....	75
15.3.3	Architectural, Mechanical, and Electrical Components Supported by Nonbuilding Structures	75
CHAPTER 18, SEISMIC DESIGN REQUIREMENTS FOR STRUCTURES WITH DAMPING SYSTEMS		77
SECTION 18.2.3.2 EQUIVALENT LATERAL FORCE PROCEDURE.....		77
CHAPTER 19, SOIL-STRUCTURE INTERACTION FOR SEISMIC DESIGN.....		79
SECTION 19.3 FOUNDATION EFFECTS		79
19.3.1	Foundation Damping Requirements.....	79
19.3.2	Effective Damping Ratio.....	79
19.3.3	Radiation Damping for Rectangular Foundations.....	81
19.3.4	Radiation Damping for Circular Foundations	83
19.3.5	Soil Damping	84
CHAPTER 20, SITE CLASSIFICATION PROCEDURE FOR SEISMIC DESIGN.....		86
SECTION 20.1 SITE CLASSIFICATION		86
SECTION 20.2 SITE CLASS DEFINITIONS.....		86
20.2.1	Site Class F.....	87
20.2.2	Site Class E (Soft Clay).....	87
20.2.3	Site Classes C, CD, D, DE and E	87
20.2.4	Site Class B and BC (Medium Hard and Soft Rock)	87
20.2.5	Site Class A (Hard Rock).....	87
SECTION 20.3 ESTIMATION OF SHEAR WAVE VELOCITY PROFILES		88
SECTION 20.4 DEFINITIONS OF SITE CLASS PARAMETERS		88

20.4.1 \bar{v}_s , AVERAGE SHEAR WAVE VELOCITY	88
CHAPTER 21, SITE SPECIFIC GROUND MOTION PROCEDURES FOR SEISMIC DESIGN	90
SECTION 21.1 SITE RESPONSE ANALYSIS	90
21.1.1 Base Ground Motions	90
21.1.2 Site Condition Modeling	90
21.1.3 Site Response Analysis and Computed Results	90
SECTION 21.2 RISK-TARGETED MAXIMUM CONSIDERED EARTHQUAKE (MCE _R) GROUND MOTION HAZARD ANALYSIS	91
21.2.1 Probabilistic (MCE _R) Ground Motions	91
21.2.2 Deterministic (MCE _R) Ground Motions	91
21.2.3 Site-Specific MCE _R Response Spectrum	93
SECTION 21.3 DESIGN RESPONSE SPECTRUM	93
SECTION 21.4 DESIGN ACCELERATION PARAMETERS	93
SECTION 21.5 MAXIMUM CONSIDERED EARTHQUAKE GEOMETRIC MEAN (MCE _G) PEAK GROUND ACCELERATION	94
21.5.1 Probabilistic MCE _G Peak Ground Acceleration	94
21.5.2 Deterministic MCE _G Peak Ground Acceleration	94
21.5.3 Site-Specific MCE _G Peak Ground Acceleration <i>PGA_M</i>	94
CHAPTER 22, SEISMIC GROUND MOTION AND LONG-PERIOD TRANSITION MAPS	96
PART 2, COMMENTARY	113
COMMENTARY TO CHAPTER 11, SEISMIC DESIGN CRITERIA	114
C11.1 GENERAL	114
C11.1.1 Purpose	115
C11.1.2 Scope	115
C11.1.3 Applicability	116
C11.1.4 Alternate Materials and Methods of Construction	116
C11.1.5 Quality Assurance	116
C11.2 DEFINITIONS	117
C11.3 SYMBOLS	123
C11.4 SEISMIC GROUND MOTION VALUES	124
C11.4.1 Near-Fault Sites	125
C11.4.2 Site Class	125
C11.4.2.1 Default Site Class	125
C11.4.3 Risk-Targeted Maximum Considered Earthquake (MCER) Spectral Response Acceleration Parameters	126
C11.4.4 Design Spectral Acceleration Parameters	126
C11.4.5 Design Response Spectrum	126
C11.4.5.1 Multi-Period Design Response Spectrum	126
C11.4.5.2 Two-Period Design Response Spectrum	127
C11.4.6 SITE-SPECIFIC GROUND MOTION PROCEDURES	127
C11.5 IMPORTANCE FACTOR AND RISK CATEGORY	127
C11.5.1 Importance Factor	128
C11.5.2 Protected Access for Risk Category IV	129
C11.6 SEISMIC DESIGN CATEGORY	129
C11.7 DESIGN REQUIREMENTS FOR SEISMIC DESIGN CATEGORY A	131

C11.8 GEOLOGIC HAZARDS AND GEOTECHNICAL INVESTIGATION	132
C11.8.1 Site Limitation for Seismic Design Categories E and F.	132
C11.8.2 Geotechnical Investigation Report Requirements for Seismic Design Categories C through F.	132
C11.8.3 Additional Geotechnical Investigation Report Requirements for Seismic Design Categories D through F.	132
C11.9 VERTICAL GROUND MOTIONS FOR SEISMIC DESIGN	134
C11.9.1 General	134
C11.9.2 MCE_R Vertical Response Spectrum.....	134
REFERENCES	137
OTHER REFERENCES (NOT CITED)	138

COMMENTARY TO CHAPTER 12, SEISMIC DESIGN REQUIREMENTS FOR BUILDING STRUCTURES..... 140

C12.1 STRUCTURAL DESIGN BASIS.....	140
C12.1.1 Basic Requirements.....	140
C12.1.2 Member Design, Connection Design, and Deformation Limit.....	144
C12.1.3 Continuous Load Path and Interconnection.....	144
C12.1.4 Connection to Supports.	144
C12.1.5 Foundation Design.....	145
C12.1.6 Material Design and Detailing Requirements.....	145
C12.2 STRUCTURAL SYSTEM SELECTION	145
C12.2.1 Seismic Force-Resisting System Selection and Limitations.....	145
C12.2.1.1 Alternative Structural Systems.	149
C12.2.1.2 Elements of Seismic Force-Resisting Systems.....	150
C12.2.2 Combinations of Framing Systems in Different Directions.	151
C12.2.3 Combinations of Framing Systems in the Same Direction.....	151
C12.2.3.1 R , C_d , and Ω_0 Values for Vertical Combinations.....	151
C12.2.3.2 Two-Stage Analysis Procedure.....	151
C12.2.3.3 R , C_d , and Ω_0 Values for Horizontal Combinations.....	152
C12.2.4 Combination Framing Detailing Requirements.....	152
C12.2.5 System-Specific Requirements.....	152
C12.2.5.1 Dual System.....	152
C12.2.5.2 Cantilever Column Systems.	153
C12.2.5.3 Inverted Pendulum-Type Structures.....	153
C12.2.5.4 Increased Structural Height Limit for Steel Eccentrically Braced Frames, Steel Special Concentrically Braced Frames, Steel Buckling-Restrained Braced Frames, Steel Special Plate Shear Walls, and Special Reinforced Concrete Shear Walls.	153
C12.2.5.5 Special Moment Frames in Structures Assigned to Seismic Design Categories D through F.....	153
C12.2.5.6 Steel Ordinary Moment Frames.....	154
C12.2.5.6.1 Seismic Design Category D or E.	155
C12.2.5.6.2 Seismic Design Category F.	156
C12.2.5.7 Steel Intermediate Moment Frames.....	156
C12.2.5.7.1 Seismic Design Category D.....	156
C12.2.5.7.2 Seismic Design Category E.	156
C12.2.5.7.3 Seismic Design Category F.	156
C12.2.5.8 Shear Wall–Frame Interactive Systems.....	156
C12.3 DIAPHRAGM FLEXIBILITY, CONFIGURATION IRREGULARITIES, AND REDUNDANCY	157
C12.3.1 Diaphragm Flexibility.	157
C12.3.1.1 Flexible Diaphragm Condition.....	157

C12.3.1.2 Rigid Diaphragm Condition.	157
C12.3.1.3 Calculated Flexible Diaphragm Condition.	158
C12.3.2 Irregular and Regular Classification.	158
C12.3.2.1 Horizontal Irregularity.	158
C12.3.2.2 Vertical Irregularity.	159
C12.3.3 Limitations and Additional Requirements for Systems with Structural Irregularities.	161
C12.3.3.1 Prohibited Horizontal and Vertical Irregularities for Seismic Design Categories D through F.	161
C12.3.3.2 Extreme Weak Stories.	161
C12.3.3.3 Elements Supporting Discontinuous Walls or Frames.	162
C12.3.3.4 Increase in Forces Caused by Irregularities for Seismic Design Categories D through F.	163
C12.3.4 Redundancy.	163
C12.3.4.1 Conditions Where Value of ρ is 1.0.	163
C12.3.4.2 Redundancy Factor, ρ , for Seismic Design Categories D through F.	164
C12.4 SEISMIC LOAD EFFECTS AND COMBINATIONS.	166
C12.4.1 Applicability.	166
C12.4.2 Seismic Load Effect.	166
C12.4.2.1 Horizontal Seismic Load Effect.	166
C12.4.2.2 Vertical Seismic Load Effect.	167
C12.4.3 Seismic Load Effects Including Overstrength.	167
C12.4.3.1 Horizontal Seismic Load Effect Including Overstrength.	167
C12.4.3.2 Capacity-Limited Horizontal Seismic Load Effect.	167
C12.4.4 Minimum Upward Force for Horizontal Cantilevers for Seismic Design Categories D through F.	168
C12.5 DIRECTION OF LOADING.	168
C12.5.1 Direction of Loading Criteria.	168
C12.5.2 Seismic Design Category B.	168
C12.5.3 SEISMIC DESIGN CATEGORY C.	168
C12.5.4 Seismic Design Categories D through F.	169
C12.6 ANALYSIS PROCEDURE SELECTION.	170
C12.7 MODELING CRITERIA.	170
C12.7.1 Foundation Modeling.	170
C12.7.2 Effective Seismic Weight.	171
C12.7.3 Structural Modeling.	171
C12.7.4 Interaction Effects.	172
C12.8 EQUIVALENT LATERAL FORCE PROCEDURE.	173
C12.8.1 Seismic Base Shear.	173
C12.8.1.1 Calculation of Seismic Response Coefficient.	173
C12.8.1.2 Soil–Structure Interaction Reduction.	175
C12.8.1.3 Maximum S_{DS} Value in Determination of C_s and E_v	175
C12.8.2 Period Determination.	175
C12.8.2.1 Approximate Fundamental Period.	177
C12.8.3 Vertical Distribution of Seismic Forces.	177
C12.8.4 Horizontal Distribution of Forces.	179
C12.8.4.1 Inherent Torsion.	179
C12.8.4.2 Accidental Torsion.	180
C12.8.4.3 Amplification of Accidental Torsional Moment.	181
C12.8.5 Overturning.	182
C12.8.6 Displacement and Drift Determination.	182
C12.8.6.1 Minimum Base Shear for Computing Drift.	185
C12.8.6.2 Period for Computing Drift.	185
C12.8.7 P-Delta Effects.	186

C12.9 LINEAR DYNAMIC ANALYSIS	190
C12.9.1 Modal Response Spectrum Analysis	190
C12.9.1.1 Number of Modes	191
C12.9.1.2 Modal Response Parameters	191
C12.9.1.3 Combined Response Parameters	192
C12.9.1.4 Scaling Design Values of Combined Response	192
C12.9.1.4.1 Scaling of Forces	192
C12.9.1.4.2 Scaling of Drifts	193
C12.9.1.5 Horizontal Shear Distribution	193
C12.9.1.6 P-Delta Effects	194
C12.9.1.7 Soil–Structure Interaction Reduction	194
C12.9.1.8 Structural Modeling	194
C12.9.2 Linear Response History Analysis	194
C12.9.2.1 General Requirements	194
C12.9.2.2 General Modeling Requirements	194
C12.9.2.2.1 P-Delta Effects	194
C12.9.2.2.2 Accidental Torsion	195
C12.9.2.2.3 Foundation Modeling	195
C12.9.2.2.4 Number of Modes to Include in Modal Response History Analysis	195
C12.9.2.2.5 Damping	196
C12.9.2.3 Ground Motion Selection and Modification	196
C12.9.2.3.1 Procedure for Spectrum Matching	197
C12.9.2.4 Application of Ground Acceleration Histories	197
C12.9.2.5 Modification of Response for Design	197
C12.9.2.6 Enveloping of Force Response Quantities	197
C12.10 DIAPHRAGMS, CHORDS, AND COLLECTORS	198
C12.10.1 Diaphragm Design	198
C12.10.1.1 Diaphragm Design Forces	200
C12.10.2.1 Collector Elements Requiring Load Combinations Including Overstrength for Seismic Design Categories C through F	200
C12.10.3 Alternative Design Provisions for Diaphragms, Including Chords and Collectors	200
C12.10.3.1 Design	201
C12.10.3.2 Seismic Design Forces for Diaphragms, Including Chords and Collectors	201
C12.10.3.3 Transfer Forces in Diaphragms	205
C12.10.3.4 Collectors—Seismic Design Categories C through F	206
C12.10.3.5 Diaphragm Design Force Reduction Factor	206
C12.10.4 Alternative Diaphragm Design Provisions for One-Story Structures with Flexible Wood Structural Panel Diaphragms and Rigid Vertical Elements	214
C12.11 STRUCTURAL WALLS AND THEIR ANCHORAGE	222
C12.11.1 Design for Out-of-Plane Forces	222
C12.11.2 Anchorage of Structural Walls and Transfer of Design Forces into Diaphragms or Other Supporting Structural Elements	222
C12.11.2.1 Wall Anchorage Forces	223
C12.11.2.2 Additional Requirements for Anchorage of Concrete or Masonry Structural Walls to Diaphragms in Structures Assigned to Seismic Design Categories C through F	223
C12.11.2.2.1 Transfer of Anchorage Forces into Diaphragm	223
C12.11.2.2.2 Steel Elements of Structural Wall Anchorage System	223
C12.11.2.2.3 Wood Diaphragms	223
C12.11.2.2.4 Metal Deck Diaphragms	224
C12.11.2.2.5 Embedded Straps	224
C12.11.2.2.6 Eccentrically Loaded Anchorage System	225
C12.11.2.2.7 Walls with Pilasters	225

C12.12 DRIFT AND DEFORMATION	226
C12.12.3 Structural Separation.	227
C12.12.4 Members Spanning between Structures.....	228
C12.12.5 Deformation Compatibility for Seismic Design Categories D through F.....	228
C12.13 FOUNDATION DESIGN	229
C12.13.1 Design Basis.	229
C12.13.3 Foundation Load-Deformation Characteristics.	229
C12.13.4 Reduction of Foundation Overturning.	230
C12.13.5 Strength Design for Foundation Geotechnical Capacity.	230
C12.13.5.1.1 Soil Strength Parameters.....	230
C12.13.5.2 Resistance Factors.	232
C12.13.5.3 Acceptance Criteria.	232
C12.13.6 Allowable Stress Design for Foundation Geotechnical Capacity.....	232
C12.13.7 Requirements for Structures Assigned to Seismic Design Category C	232
C12.13.7.1 Pole-Type Structures.	232
C12.13.7.2 Foundation Ties.	232
C12.13.7.3 Pile Anchorage Requirements.	233
C12.13.8 Requirements for Structures Assigned to Seismic Design Categories D through F	233
C12.13.8.1 Pole-Type Structures.	233
C12.13.8.2 Foundation Ties.	233
C12.13.8.3 General Pile Design Requirement.....	233
C12.13.8.4 Batter Piles.....	233
C12.13.8.5 Pile Anchorage Requirements.	234
C12.13.8.6 Splices of Pile Segments.....	234
C12.13.8.7 Pile–Soil Interaction.	234
C12.13.8.8 Pile Group Effects.	234
C12.13.9 Requirements for Foundations on Liquefiable Sites.....	234
C12.13.9.1 Foundation Design.....	236
C12.13.9.2 Shallow Foundations.	236
C12.13.9.3 Deep Foundations.	237
C12.14 SIMPLIFIED ALTERNATIVE STRUCTURAL DESIGN CRITERIA FOR SIMPLE BEARING WALL OR BUILDING FRAME SYSTEMS	239
C12.14.1 General.	239
C12.14.1.1 Simplified Design Procedure.....	239
C12.14.3 Seismic Load Effects and Combinations.....	240
C12.14.7 DESIGN AND DETAILING REQUIREMENTS.	241
C12.14.8 SIMPLIFIED LATERAL FORCE ANALYSIS PROCEDURE	241
C12.14.8.1 Seismic Base Shear.....	241
C12.14.8.2 Vertical Distribution.	241
C12.14.8.5 Drift Limits and Building Separation.	241
REFERENCES	241
OTHER REFERENCES (NOT CITED)	246

COMMENTARY TO CHAPTER 13, SEISMIC DESIGN REQUIREMENTS FOR NONSTRUCTURAL COMPONENTS 248

C13.1 GENERAL	248
C13.1.1 Scope.	251
C13.1.2 Seismic Design Category.	252
C13.1.3 Component Importance Factor.	253
C13.1.4 Exemptions.....	253
C13.1.5 Premanufactured Modular Mechanical and Electrical Systems.	255
C13.1.6 Application of Nonstructural Component Requirements to Nonbuilding Structures.	255

C13.1.7 Reference Documents.....	256
C13.1.8 Reference Documents Using Allowable Stress Design.....	256
C13.2 GENERAL DESIGN REQUIREMENTS.....	257
C13.2.1 Applicable Requirements for Architectural, Mechanical, and Electrical Components, Supports, and Attachments.....	257
C13.2.2 Special Certification Requirements for Designated Seismic Systems.....	257
C13.2.3 Consequential Damage.....	258
C13.2.4 Flexibility.....	259
C13.2.5 Testing Alternative for Seismic Capacity Determination.....	260
C13.2.6 Experience Data Alternative for Seismic Capacity Determination.....	261
C13.2.7 Construction Documents.....	262
C13.2.8 Supported Nonstructural Components with Greater Than or Equal to 20% Combined Weight.....	262
C13.3 SEISMIC DEMANDS ON NONSTRUCTURAL COMPONENTS.....	262
C13.3.1 Seismic Design Force.....	262
C13.3.1.1 Amplification with Height, H_f	266
C13.3.1.5 Nonlinear Response History Analysis.....	266
C13.3.2 Seismic Relative Displacements.....	267
C13.3.2.1 Displacements within Structures.....	267
C13.3.2.2 Displacements between Structures.....	268
C13.3.3 Component Period.....	269
C13.4 NONSTRUCTURAL COMPONENT ANCHORAGE.....	269
C13.4.1 Design Force in the Attachment.....	270
C13.4.2 Anchors in Concrete or Masonry.....	270
C13.4.3 Installation Conditions.....	272
C13.4.4 Multiple Attachments.....	272
C13.4.5 Power-Actuated Fasteners.....	272
C13.4.6 Friction Clips.....	272
C13.5 ARCHITECTURAL COMPONENTS.....	273
C13.5.1 General.....	273
C13.5.2 Forces and Displacements.....	274
C13.5.3 Exterior Nonstructural Wall Elements and Connections.....	274
C13.5.4 Glass.....	275
C13.5.5 Out-of-Plane Bending.....	276
C13.5.6 Suspended Ceilings.....	276
C13.5.6.1 Seismic Forces.....	277
C13.5.6.2 Industry Standard Construction for Acoustical Tile or Lay-In Panel Ceilings.....	277
C13.5.6.2.1 Seismic Design Category C.....	283
C13.5.6.2.2 Seismic Design Categories D through F.....	283
C13.5.6.3 Integral Construction.....	284
C13.5.7 Access Floors.....	284
C13.5.7.1 General.....	284
C13.5.7.2 Special Access Floors.....	284
C13.5.8 Partitions.....	285
C13.5.9 Glass in Glazed Curtain Walls, Glazed Storefronts, and Glazed Partitions.....	285
C13.5.9.1 General.....	285
C13.5.9.2 Seismic Drift Limits for Glass Components.....	285
C13.5.10 Egress Stairs and Ramps.....	286
C13.5.11 Penthouses and Rooftop Structures.....	286
C13.6 MECHANICAL AND ELECTRICAL COMPONENTS.....	287
C13.6.1 General.....	288
C13.6.2 Mechanical Components and C13.6.3 Electrical Components.....	288

C13.6.4 Component Supports	291
Figure C13.6.4.4 Example of a distribution system support for piping. (FEMA E-74).....	294
C13.6.4.1 Design Basis	294
C13.6.4.2 Design for Relative Displacement	295
C13.6.4.3 Support Attachment to Component	295
C13.6.4.5 Additional Requirements	295
C13.6.5 Distribution Systems: Conduit, Cable Tray, and Raceways	296
C13.6.6 Distribution Systems: Duct Systems.....	296
C13.6.7 Distribution Systems: Piping and Tubing Systems.....	296
C13.6.7.1 ASME Pressure Piping Systems	298
C13.6.7.2 Fire Protection Sprinkler Piping Systems	298
C13.6.7.3 Exceptions	299
C13.6.9 Utility and Service Lines	299
C13.6.10 Boilers and Pressure Vessels	299
C13.6.11 Elevator and Escalator Design Requirements.....	299
C13.6.11.3 Seismic Controls for Elevators	299
C13.6.11.4 Retainer Plates	300
C13.6.12 Rooftop Solar Panels	300
C13.6.13 Other Mechanical and Electrical Components	300
REFERENCES	301
OTHER REFERENCES (NOT CITED)	303

COMMENTARY TO CHAPTER 14, MATERIAL-SPECIFIC SEISMIC DESIGN AND DETAILING REQUIREMENTS 306

C14.0 SCOPE	306
C14.1 STEEL	306
C14.1.1 Reference Documents.....	306
C14.1.2 Structural Steel	306
C14.1.2.1 General	306
C14.1.2.2 Seismic Requirements for Structural Steel Structures	306
C14.1.2.2.1 Seismic Design Categories B and C	306
C14.1.2.2.2 Seismic Design Categories D through F.....	307
C14.1.3 COLD-FORMED STEEL	307
C14.1.3.1 General	307
C14.1.3.2 Seismic Requirements for Cold-Formed Steel Structures	307
C14.1.4 Cold-Formed Steel Light-Frame Construction.....	307
C14.1.4.1 General	307
C14.1.4.2 Seismic Requirements for Cold-Formed Steel Light-Frame Construction	308
C14.1.4.3 Prescriptive Cold-Formed Steel Light-Frame Construction	308
C14.1.5 Cold-Formed Steel Deck Diaphragms.....	308
C14.1.7 Steel Cables	312
C14.1.8 Additional Detailing Requirements for Steel Piles in Seismic Design Categories D through F.....	312
C14.2 CONCRETE.....	312
C14.2.2.1 Definitions	312
C14.2.2.2 ACI 318, Section 10.7.6	313
C14.2.2.3 Scope	313
C14.2.2.4 Intermediate Precast Structural Walls.....	313
C14.2.2.6 Foundations	313
C14.2.2.7 Detailed Plain Concrete Shear Walls.....	313
C14.2.3 Additional Detailing Requirements for Concrete Piles	313
C14.2.3.1.2 Reinforcement for Uncased Concrete Piles (SDC C).....	314

C14.2.3.1.5 Reinforcement for Precast Nonprestressed Piles (SDC C)	314
C14.2.3.1.6 Reinforcement for Precast Prestressed Piles (SDC C).....	314
C14.2.3.2.3 Reinforcement for Uncased Concrete Piles (SDC D through F)	314
C14.2.3.2.5 Reinforcement for Precast Nonprestressed Piles (SDC D through F)	314
C14.2.3.2.6 Reinforcement for Precast Prestressed Piles (SDC D through F).....	314
C14.2.4 Additional Design and Detailing Requirements for Precast Concrete Diaphragms.	315
C14.2.4.1 Diaphragm Seismic Demand Levels.....	315
C14.2.4.2 Diaphragm Design Options.	317
C14.2.4.3 Diaphragm Connector or Joint Reinforcement Deformability.....	320
C14.2.4.3.5 Deformed Bar Reinforcement.....	321
C14.2.4.3.6 Special Inspection.	321
C14.2.4.4 Precast Concrete Diaphragm Connector and Joint Reinforcement Qualification Procedure.	321
C14.2.4.4.1 Test Modules.	321
C14.2.4.4.3 Test Configuration.....	321
C14.2.4.4.4 Instrumentation.....	322
C14.2.4.4.5 Loading Protocols.....	322
C14.2.4.4.6 Measurement Indices, Test Observations, and Acquisition of Data	323
C14.2.4.4.7 Response Properties.....	323
C14.2.4.4.8 Test Report.	324
C14.3 COMPOSITE STEEL AND CONCRETE STRUCTURES	324
C14.3.1 Reference Documents.....	324
C14.3.4 Metal-Cased Concrete Piles.....	325
C14.3.5 Seismic Requirements for Coupled Composite Plate Shear Walls --Concrete Filled (CC-PSW/CF).....	325
C14.3.5.1 Scope.	325
C14.3.5.2 Basis of Design.....	326
C14.3.5.3 Analysis	326
C14.3.5.3.1 Elastic Analysis.	329
C14.3.5.3.4 Capacity-Limited Analysis.	329
C14.3.5.4 Composite Wall Requirements	330
C14.3.5.4.1 Minimum Area of Steel.	330
C14.3.5.4.2 Slenderness Requirement.....	330
C14.3.5.4.3 Tie Spacing Requirement for Composite Walls.	330
C14.3.5.4.4 Tie-to-Plate Connection.....	331
C14.3.5.5 Composite Coupling Beam Requirements.....	332
C14.3.5.5.1 Minimum Area of Steel.	332
C14.3.5.5.2 Slenderness Requirement for Coupling Beams.	332
C14.3.5.6 Composite Wall Strength.....	332
C14.3.5.5.4 In-Plane Shear Strength.	332
C14.3.5.5 Nominal vs. Expected Flexural Capacity.....	333
C14.3.5.6 Composite Coupling Beam Strength	333
C14.3.5.8 Coupling Beam-to-Wall Connections.....	334
C14.3.5.9 Composite Wall-to-Foundation Connections	336
C14.3.5.10 Protected Zones	337
C14.3.5.11 Demand Critical Welds.....	337
C14.4 MASONRY.....	338
C14.5 WOOD.....	338
C14.5.1 Reference Documents.....	338
C14.5.2 Seismic Requirements for Cross Laminated Timber Shear Walls.....	338
C14.5.2.1 Scope.	338
C14.5.2.2 Application Requirements.	339
C14.5.2.3 CLT Shear Wall Requirements.....	340
C14.5.2.3.6 Other Load Path Connections to CLT Wall Panels.	344

C14.5.2.3.7 CLT Shear Walls with Shear Resistance Provided by High Aspect Ratio Panels Only.	345
C14.5.2.4 Shear Wall Deflection.....	345
C14.5.2.7 Diaphragm Requirements.	347
REFERENCES	352
OTHER REFERENCES (NOT CITED)	355

COMMENTARY TO CHAPTER 15, SEISMIC DESIGN REQUIREMENTS FOR NONBUILDING STRUCTURES..... 360

C15.1 GENERAL	360
C15.1.1 Nonbuilding Structures	360
C15.1.2 Design.....	361
C15.1.3 Structural Analysis Procedure Selection.	361
C15.1.4 Nonbuilding Structures Sensitive to Vertical Ground Motions.	367
C15.2 NONBUILDING STRUCTURES CONNECTED BY NONSTRUCTURAL COMPONENTS TO OTHER ADJACENT STRUCTURES	368
C15.2.1 Nonbuilding Structures Connected by Nonstructural Components to Other Adjacent Structures.	368
C15.2.2 Architectural, Mechanical, and Electrical Components Spanning Between Nonbuilding Structures.	369
C15.3 NONBUILDING STRUCTURES SUPPORTED BY OTHER STRUCTURES	369
C15.3.1 Supported Nonbuilding Structures with Less Than 20% Combined Weight.	369
C15.3.2 Supported Nonbuilding Structures with Greater Than or Equal to 20% Combined Weight.....	371
C15.4 STRUCTURAL DESIGN REQUIREMENTS	372
C15.4.1 Design Basis.....	372
C15.4.1.1 Importance Factor.....	374
C15.4.2 Rigid Nonbuilding Structures.....	374
C15.4.3 Loads.....	374
C15.4.4 Fundamental Period.....	374
C15.4.7 Drift, Deflection, and Structure Separation.	375
C15.4.8 Site-Specific Response Spectra.	375
C15.4.9 Anchors in Concrete or Masonry.....	375
C15.4.9.4 ASTM F1554 Anchors.	375
C15.4.10 Requirements for Nonbuilding Structure Foundations on Liquefiable Sites.	375
C15.5 NONBUILDING STRUCTURES SIMILAR TO BUILDINGS.....	375
C15.5.1 General.....	375
C15.5.2 Pipe Racks.....	376
C15.5.3.1 Steel Storage Racks.....	376
C15.5.3.2 Steel Cantilevered Storage Racks.....	377
C15.5.4 Electrical Power-Generating Facilities.....	378
C15.5.5 Structural Towers for Tanks and Vessels.....	378
C15.5.6 Piers and Wharves.....	379
C15.6 GENERAL REQUIREMENTS FOR NONBUILDING STRUCTURES NOT SIMILAR TO BUILDINGS.....	380
C15.6.1 Earth-Retaining Structures.....	380
C15.6.2 Chimneys and Stacks.....	380
C15.6.2.1 General.....	380
C15.6.2.2 Concrete Chimneys and Stacks.....	380
C15.6.2.3 Steel Chimneys and Stacks.....	381
C15.6.4 Special Hydraulic Structures.....	381
C15.6.5 Secondary Containment Systems.....	381

C15.6.5.1 Freeboard.....	382
C15.6.6 Telecommunication Towers.....	382
C15.6.7 Steel Tubular Support Structures for Onshore Wind Turbine Generator Systems.....	382
C15.6.8 Ground-Supported Cantilever Walls or Fences.....	383
C15.7 TANKS AND VESSELS.....	384
C15.7.1 General.....	384
C15.7.2 Design Basis.....	385
C15.7.3 Strength and Ductility.....	387
C15.7.4 Flexibility of Piping Attachments.....	387
C15.7.5 Anchorage.....	388
C15.7.6 Ground-Supported Storage Tanks for Liquids.....	388
C15.7.6.1 General.....	388
C15.7.6.1.1 Distribution of Hydrodynamic and Inertia Forces.....	389
C15.7.6.1.2 Sloshing.....	389
C15.7.6.1.4 Internal Elements.....	390
C15.7.6.1.5 Sliding Resistance.....	390
C15.7.6.1.6 Local Shear Transfer.....	391
C15.7.6.1.7 Pressure Stability.....	391
C15.7.6.1.8 Shell Support.....	391
C15.7.6.1.9 Repair, Alteration, or Reconstruction.....	391
C15.7.7 Water Storage and Water Treatment Tanks and Vessels.....	391
C15.7.7.1 Welded Steel.....	392
C15.7.7.2 Bolted Steel.....	392
C15.7.7.3 Reinforced and Prestressed Concrete.....	392
C15.7.8 Petrochemical and Industrial Tanks and Vessels Storing Liquids.....	392
C15.7.8.1 Welded Steel.....	392
C15.7.8.2 Bolted Steel.....	393
C15.7.9 Ground-Supported Storage Tanks for Granular Materials.....	393
C15.7.9.1 General.....	393
C15.7.9.2 Lateral Force Determination.....	393
C15.7.9.3 Force Distribution to Shell and Foundation.....	393
C15.7.9.3.1 Increased Lateral Pressure.....	393
C15.7.9.3.2 Effective Mass.....	394
C15.7.9.3.3 Effective Density.....	394
C15.7.9.3.4 Lateral Sliding.....	394
C15.7.9.3.5 Combined Anchorage Systems.....	394
C15.7.10 Elevated Tanks and Vessels for Liquids and Granular Materials.....	394
C15.7.10.1 General.....	394
C15.7.10.4 Transfer of Lateral Forces into Support Tower.....	401
C15.7.10.5 Evaluation of Structures Sensitive to Buckling Failure.....	401
C15.7.10.7 Concrete Pedestal (Composite) Tanks.....	401
C15.7.11 Boilers and Pressure Vessels.....	402
C15.7.12 Liquid and Gas Spheres.....	402
C15.7.13 Refrigerated Gas Liquid Storage Tanks and Vessels.....	402
C15.7.14 Horizontal, Saddle-Supported Vessels for Liquid or Vapor Storage.....	402
C15.8 CONSENSUS STANDARDS AND OTHER REFERENCED DOCUMENTS.....	402
REFERENCES.....	403
OTHER REFERENCES (NOT CITED).....	406
COMMENTARY TO CHAPTER 16, SEISMIC RESPONSE HISTORY PROCEDURES.....	407
C16.1 GENERAL REQUIREMENTS.....	407
C16.1.1 Scope.....	407
C16.1.2. Linear Analysis.....	408

C16.1.3 Vertical Response Analysis.....	408
C16.1.4 Documentation.....	409
C16.2 GROUND MOTIONS.....	409
C16.2.1 Target Response Spectrum.....	409
C16.2.2 Ground Motion Selection.....	411
C16.2.3 Ground Motion Modification.....	413
C16.2.3.1 Period Range for Scaling or Matching.....	414
C16.2.3.2 Amplitude Scaling.....	414
C16.2.3.3 Spectral Matching.....	415
C16.2.4 Application of Ground Motions to the Structural Model.....	415
C16.3 MODELING AND ANALYSIS.....	416
C16.3.1 Modeling.....	416
C16.3.3 P-Delta Effects.....	418
C16.3.4 Torsion.....	418
C16.3.5 Damping.....	419
C16.3.6 Explicit Foundation Modeling.....	419
C16.4.1 Global Acceptance Criteria.....	420
C16.4.1.1 Unacceptable Response.....	420
C16.4.1.2 Story Drift.....	424
C16.4.2 Element-Level Acceptance Criteria.....	425
C16.4.2.1 Force-Controlled Actions.....	426
C16.4.2.2 Deformation-Controlled Actions.....	431
C16.4.2.3 Elements of the Gravity Force-Resisting System.....	434
REFERENCES.....	434
OTHER REFERENCES (NOT CITED).....	435

COMMENTARY TO CHAPTER 17, SEISMIC DESIGN REQUIREMENTS FOR SEISMICALLY ISOLATED STRUCTURES 436

C17.1 GENERAL.....	436
C17.2 GENERAL DESIGN REQUIREMENTS.....	438
C17.2.4 Isolation System.....	440
C17.2.4.1 Environmental Conditions.....	440
C17.2.4.2 Wind Forces.....	440
C17.2.4.3 Fire Resistance.....	440
C17.2.4.4 Lateral Restoring Force.....	440
C17.2.4.5 Displacement Restraint.....	441
C17.2.4.6 Vertical-Load Stability.....	441
C17.2.4.7 Overturning.....	441
C17.2.4.8 Inspection and Replacement.....	441
C17.2.4.9 Quality Control.....	441
C17.2.5 Structural System.....	442
C17.2.5.1 Minimum Building Separations.....	442
C17.2.5.4 Steel Ordinary Concentrically Braced Frames.....	442
C17.2.5.5 Isolation System Connections.....	443
C17.2.6 Elements of Structures and Nonstructural Components.....	443
C17.2.8 Isolation System Properties.....	447
C17.2.8.2 Isolator Unit Nominal Properties.....	447
C17.2.8.3 Bounding Properties of Isolation System Components.....	448
C17.2.8.4 Property Modification Factors.....	449
C17.2.8.5 Upper Bound and Lower Bound Force-Deflection Behavior of Isolation System Components.....	455
C17.3 SEISMIC GROUND MOTION CRITERIA.....	455

C17.3.1 Site-Specific Seismic Hazard.....	455
C17.3.3 MCE _R Ground Motion Records.....	455
C17.4 ANALYSIS PROCEDURE SELECTION	456
C17.5 EQUIVALENT LATERAL FORCE PROCEDURE.....	457
C17.5.3 Minimum Lateral Displacements Required for Design	457
C17.5.3.1 Maximum Displacement.....	457
C17.5.3.2 Effective Period at the Maximum Displacement.....	457
C17.5.3.3 Total Maximum Displacement.....	457
C17.5.4 Minimum Lateral Forces Required for Design.....	458
C17.5.4.1 Isolation System and Structural Elements below the Base Level.....	461
C17.5.4.2 Structural Elements above the Base Level.....	461
C17.5.4.3 Limits on V_s	461
C17.5.5 Vertical Distribution of Force.....	462
C17.5.6 Drift Limits.....	465
C17.6 DYNAMIC ANALYSIS PROCEDURES.....	465
C17.6.2 Modeling.....	467
C17.6.3.4 Response History Analysis Procedure.....	467
C17.7 DESIGN REVIEW.....	468
C17.8 TESTING.....	468
C17.8.2.2 Sequence and Cycles.....	468
C17.8.2.3 Dynamic Testing.....	469
C17.8.2.4 Units Dependent on Bilateral Load.....	470
C17.8.2.5 Maximum and Minimum Vertical Load.....	470
C17.8.2.7 Testing Similar Units.....	470
C17.8.3 Determination of Force-Deflection Characteristics.....	471
C17.8.4 Test Specimen Adequacy.....	472
C17.8.5 Production Tests.....	473
REFERENCES.....	473
OTHER REFERENCES (NOT CITED).....	475

COMMENTARY TO CHAPTER 18, SEISMIC DESIGN REQUIREMENTS FOR STRUCTURES WITH DAMPING SYSTEMS..... 478

C18.1 GENERAL	478
C18.2 GENERAL DESIGN REQUIREMENTS.....	478
C18.2.1 System Requirements.....	478
C18.2.1.2 Damping System.....	479
C18.2.2 Seismic Ground Motion Criteria	479
C18.2.3 Procedure Selection.....	479
C18.2.4.1 Device Design.....	480
C18.2.4.4 Nominal Design Properties.....	482
C18.2.4.5 Maximum and Minimum Damper Properties Specification Tolerance on Nominal Design Properties.....	482
C18.2.4.6 Damping System Redundancy.....	484
C18.3 NONLINEAR RESPONSE HISTORY PROCEDURE.....	484
C18.3.2 Accidental Mass Eccentricity.....	485
C18.4 SEISMIC LOAD CONDITIONS AND ACCEPTANCE CRITERIA FOR NONLINEAR RESPONSE HISTORY PROCEDURE	486
C18.4.1 Seismic Force-Resisting System.....	486
C18.5 DESIGN REVIEW.....	487

C18.6 TESTING.....	487
C18.6.1.2 Sequence and Cycles of Testing.....	487
C18.6.1.3 Testing Similar Devices.....	487
C18.6.1.4 Determination of Force-Velocity-Displacement Characteristics.....	487
C18.6.2 Production Tests.....	487
C18.7 ALTERNATE PROCEDURES AND CORRESPONDING ACCEPTANCE CRITERIA.....	488
C18.7.1 Response-Spectrum Procedure and C18.7.2 Equivalent Lateral Force Procedure.....	488
C18.7.3 Damped Response Modification.....	491
C18.7.3.1 Damping Coefficient.....	491
C18.7.3.2 Effective Damping.....	492
C18.7.4 Seismic Load Conditions and Acceptance Criteria for RSA and ELF Procedures.....	492
C18.7.4.5 Seismic Load Conditions and Combination of Modal Responses.....	492
REFERENCES.....	492
OTHER REFERENCES (NOT CITED).....	493
COMMENTARY TO CHAPTER 19, SOIL-STRUCTURE INTERACTION FOR SEISMIC DESIGN.....	495
C19.1 GENERAL.....	495
C19.2 SSI ADJUSTED STRUCTURAL DEMANDS.....	496
C19.3 FOUNDATION DAMPING EFFECTS.....	499
C19.4 KINEMATIC SSI EFFECTS.....	501
C19.4.1 Base Slab Averaging.....	502
C19.4.2 Embedment.....	503
REFERENCES.....	503
COMMENTARY TO CHAPTER 20, SITE CLASSIFICATION PROCEDURE FOR SEISMIC DESIGN .	506
C20.1 SITE CLASSIFICATION.....	506
C20.2 SITE CLASS DEFINITIONS.....	506
C20.2.1 Site Class F.....	506
C20.3 ESTIMATION OF SHEAR WAVE VELOCITY PROFILES.....	507
C20.4 DEFINITIONS OF SITE CLASS PARAMETERS.....	512
REFERENCES.....	512
COMMENTARY TO CHAPTER 21, SITE-SPECIFIC GROUND MOTION PROCEDURES FOR SEISMIC DESIGN.....	514
C21.0 GENERAL.....	514
C21.1 SITE RESPONSE ANALYSIS.....	515
C21.1.1 Base Ground Motions.....	515
C21.1.2 Site Condition Modeling.....	515
C21.1.3 Site Response Analysis and Computed Results.....	516
C21.2 RISK-TARGETED MAXIMUM CONSIDERED EARTHQUAKE (MCE _R) GROUND MOTION HAZARD ANALYSIS.....	516
C21.2.1 Probabilistic (MCE _R) Ground Motions.....	516
C21.2.2 Deterministic (MCE _R) Ground Motions.....	517
C21.2.3 Site-Specific MCE _R	518
C21.3 DESIGN RESPONSE SPECTRUM.....	519

C21.4 DESIGN ACCELERATION PARAMETERS	519
C21.5 MAXIMUM CONSIDERED EARTHQUAKE GEOMETRIC MEAN (MCE _G) PEAK GROUND ACCELERATION	520
REFERENCES	520
OTHER REFERENCES (NOT CITED)	522
COMMENTARY TO CHAPTER 22, SEISMIC GROUND MOTION AND LONG-PERIOD TRANSITION MAPS	524
RISK-TARGETED MAXIMUM CONSIDERED EARTHQUAKE (MCE _R) SPECTRAL RESPONSE ACCELERATIONS	539
MAXIMUM CONSIDERED EARTHQUAKE GEOMETRIC MEAN (MCE _G) PEAK GROUND ACCELERATIONS.....	541
LONG-PERIOD TRANSITION MAPS	541
USGS SEISMIC DESIGN GEODATABASE AND WEB SERVICE.....	542
REFERENCES	542
APPENDIX PROJECT PARTICIPANTS	546

INTRODUCTION

The 2020 edition of the *NEHRP Recommended Seismic Provisions for New Buildings and Other Structures (NEHRP Provisions)* is a consensus-based technical resource document that can be used by model codes and standards organizations, guidelines organizations and the public as the foundation for improved seismic design. The *NEHRP Provisions* has been an essential resource in the advancement of improved seismic design and construction practices. Changes contained in Parts 1 and 2 of the 2020 *NEHRP Provisions* are expected to be considered for adoption by *ASCE/SEI 7-2022 Minimum Design Loads and Associated Criteria for Buildings and Other Structures*, which will be later considered for adoption by the International Building Code (IBC) 2024.

The *NEHRP Recommended Seismic Provisions* is a major product of the National Earthquake Hazards Reduction Program (NEHRP), and results from a convergence of the efforts of the four NEHRP agencies: Federal Emergency Management Agency (FEMA), National Institute of Standards and Technology (NIST), National Science Foundation (NSF) and U.S. Geological Survey (USGS). It is developed based on extensive results and findings from research projects, problem-focused studies, and post-earthquake investigation reports conducted by various professional organizations, research institutes, universities, material industries, and the four NEHRP agencies.

What is Included in the *NEHRP Provisions*

The *NEHRP Provisions* has been focused on adoption of new/significant technologies, which are brought forth as changes to the most recent edition of *ASCE/SEI 7*, adopted by the Building Seismic Safety Council (BSSC) Provisions Update Committee (PUC) as the reference standard. Consistent with the 2009 and 2015 editions, the 2020 *NEHRP Provisions* includes two volumes:

Volume 1: Part 1 Provisions and Part 2 Commentary: Part 1 *Provisions* provides recommended changes to the seismic requirements of *ASCE/SEI 7-16*, Chapters 11 to 23. For a given chapter, only those sections with recommended modifications or additions are shown. Therefore, the Provisions Part 1 should be used side-by-side with *ASCE 7-16* in order to grasp the full context of each chapter. Part 2 *Commentary* provides a complete commentary for each chapter. It is comprised of the new commentary to each proposed change contained in Part 1 along with the existing *ASCE/SEI 7-16* commentary to unchanged sections. Therefore, the Part 2 Commentary is self-contained. Black bars in the columns indicate new commentary matching Part 1 Provisions changes.

Volume 2: Part 3 Resource Papers: Part 3 Resource Papers introduces new concepts and procedures for experimental use by the design community, researchers, and standards-development and code-development organizations. These resource papers are self-contained and not necessarily directly associated with a Part 1 provision. They are not written in standards language format. Feedback from these users is encouraged.

How the 2020 *NEHRP Provisions* is Developed

Consistent with the approach used in previous editions, the 2020 *NEHRP Provisions* is developed through a BSSC consensus process conducted by the PUC and BSSC Member Organizations. In consideration of balancing geographical and design practices, providing expertise in a broad range of subject areas, focusing on key areas of code improvement, and collaborating with national standards and codes, 23 individual experts were selected to serve as the voting members of PUC in the 2020 *NEHRP Provisions* update cycle. The PUC, with input from the earthquake engineering community, identified technical issues considered most critical for improvement of U.S. seismic design practice, and formed nine Issue Teams for developing change proposals to the *ASCE/SEI 7* standard, plus a special Project 17 Committee on Seismic Design Value Maps (later transitioned to PUC Issue Team 10). The *NEHRP Provisions* are developed and backed by a broad consensus process. Proposals are developed, vetted, and

approved within each of the Issue Teams, then all proposals are officially balloted by the PUC, with all comments and responses reviewed and resolved. Following approval by the BSSC Board of Direction, the proposals are balloted by BSSC Member Organizations, after which all their comments and responses are reviewed and resolved by the PUC. The process is briefly illustrated by the chart below.

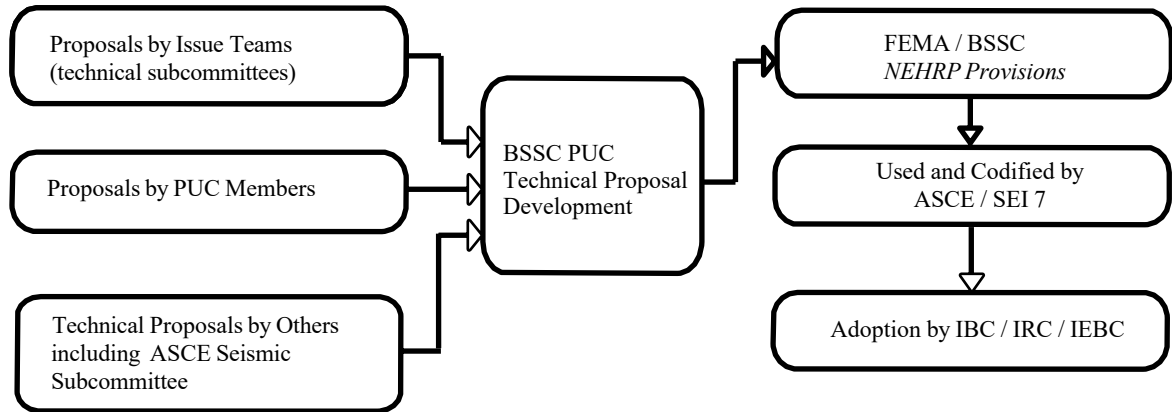

The Role of the NEHRP Provisions in the U.S. Seismic Code Development Process

Over 130 subject matter experts and FEMA, NIST, and USGS representatives contributed to the 2020 *NEHRP Provisions* development and 39 BSSC member organizations participated in the proposal vetting process. A total of 50 technical change proposals were developed and deliberated, with 37 receiving consensus approval and incorporated into the 2020 *NEHRP Provisions* publication. The project participants are presented in the Appendix and the approved change proposals are summarized in next section.

What is New in the 2020 *NEHRP Provisions*

The 2020 *NEHRP Provisions* has adopted the national standard ASCE/SEI 7-16 Chapter 11-23, including Supplement No.1 as its reference standard. Volume I Parts 1 and 2 consist of changes by the 2020 *NEHRP Provisions* to the ASCE/SEI 7-16 Chapter 11-23 and their commentaries. Topics of the Parts 1 and 2 approved changes are summarized in the table below, along with their relevant ASCE/SEI 7-16 section numbers and commentary section numbers.

Topic of Change Proposals	Brief Summary of the Changes	Related or New Sections of ASCE/SEI 7-16	Related Commentary in ASCE/SEI 7-16
Individual Structural Member Reliability Targets	Sets a target reliability for individual structural elements.	INTENT* 1.1.1 , 1.1.2 , and 1.1.3	INTENT* 2.1.1 , 2.1.2 , and 2.1.3
Essential Facility Function Reliability Targets	Sets a target reliability for loss of function of buildings and other structures assigned to Risk Category IV.	INTENT* 1.1.5	INTENT* 2.1.5
Adoption of ASCE/SEI 7-16 Chapters 11-23 and Supplement No.1	ASCE/SEI 7-16 is adopted by the PUC as the reference standard and proposals for technical changes are made relative to specific sections of the standard.	All sections of Chapter 11-23 in ASCE/SEI 7-16 without exception	All sections of C11-C23 in ASCE/SEI 7-16
Multi-Period Response Spectra (MPRS)-Chapter 11 (see below for related changes to Chapter 20, 21, and 22)	The MPRS replaces the three-domain spectral definition. It eliminates the need for site-specific hazard analysis required by ASCE/SEI 7-16 for certain (soft soil) sites. It incorporates values of S_{MS} and S_{MI} derived from multi-period MCE_R response spectra (provided online by the USGS) that include site amplification and other site dependent effects. The definition of design parameters S_{DS} and S_{DI} and their use in Chapter 12 and other chapters to define seismic loads for ELF design, etc., remain the same as that of ASCE/SEI 7-16. Traditional methods familiar to and commonly used by engineering practitioners for building design will not change.	Sections 11.2 , 11.3 , 11.4 , 11.8 and 11.9	C11.2 , C11.3 , C11.4 , C11.8 and C11.9
Vertical Ground Motions, V/H ratios	Improves methods to derive vertical response spectra from horizontal response spectra where vertical response spectra are required and the site-specific procedures of Chapter 21 are not used.	Section 11.9	C11.9

* The INTENT describes the expected seismic performance that is judged to be inherent in the seismic requirements of NEHRP Provisions. This section is not contained in ASCE/SEI 7.

Topic of Change Proposals	Brief Summary of the Changes	Related or New Sections of ASCE/SEI 7-16	Related Commentary in ASCE/SEI 7-16
Exemption for System Height Limitations	Provides an exemption that allows buildings with lateral force-resisting systems otherwise conforming to the design parameters defined in ASCE/SEI 7-16 Table 12.2-1 to exceed the height limits prescribed in the table when the building is designed in accordance with the requirements of Chapter 16.	Section 12.2.1	C12.2.1
Reinforced Concrete Ductile Coupled Walls	Introduces reinforced concrete ductile coupled walls into Table 12.2-1.	Table 12.2-1 , Section 12.2.5.4	C12.2
Coupled Composite Plate Shear Walls – Concrete Filled	Introduces steel and concrete coupled composite plate shear walls into Table 12.2-1 and adds a new Section 14.3.5 to provide specific provisions for the definition and application.	Table 12.2-1 , Sections 12.2.5.4 , 14.3.3 and 14.3.5	C12.2 and C14.3.5
Cross-Laminated Timber Shear Walls	Introduces cross-laminated timber (CLT) shear walls into Table 12.2-1 and Table 12.14-1 and adds a new section 14.5.2 for requirements of CLT shear walls.	Tables 12.2-1 and 12.14-1 , Section 14.5.2	C12.2 and C14.5.2
Elimination of Mass Irregularity	Eliminates the mass irregularity from <i>Vertical Structural Irregularities</i> in Table 12.3-2.	Table 12.3-2	C12.3.2.2
Accidental Torsion Modification	Removes some of the unnecessary conservatism from the current code provisions, while adding requirements for building configurations not adequately addressed by the current code provisions.	Table 12.3-1 and Sections 12.3.3.1 , 12.3.4.2 , 12.5.3.1	C12.3.4.2 , C12.5.3 , C12.5.4 , C12.6 and C12.8.4.3
Application of Equivalent Lateral Force Analysis Procedure	Eliminates Table 12.6-1 <i>Permitted Analytical Procedures</i> and replaces it with a sentence stating that each Chapter 12 analysis procedure is permitted for each seismic design category.	Table 12.6-1	C12.6

Topic of Change Proposals	Brief Summary of the Changes	Related or New Sections of ASCE/SEI 7-16	Related Commentary in ASCE/SEI 7-16
Alternative Diaphragm Design Provisions for One-Story Structures with Flexible Diaphragms and Rigid Vertical Elements	Adds a new Section 12.10.4 to allow using alternative diaphragm design provisions for one-story structures with flexible diaphragms and rigid vertical elements.	Sections 11.3 and 12.10	C12.10
One-Story Structures with Flexible Diaphragms and Rigid Vertical Elements	Adds a new Section 12.2.3.2.2 to allow using a two-stage equivalent lateral force analysis for one-story structures with flexible diaphragms and rigid vertical elements.	Section 12.2.3.2.2	C12.2.3.2.2
Diaphragm Seismic Design Methods Additional Commentary	Adds explanation about use of and differentiation between the diaphragm basic design method (Sections 12.10.1 and 12.10.2) and alternative method (Sections 12.10.3 and 12.10.4).		C12.10
Seismic Design of Bare Steel Deck Diaphragms	Allows the use of alternative diaphragm design procedures for bare steel deck diaphragms. Provisions are added to allow Section 12.10.3 and Section 12.10.4 to be used and a new Section 14.1.5.1 is added to provide the detailing requirements.	Sections 12.10 , and 14.1.5 and Table 12.10-1	C12.10 , C14.1.5
Design Story Drift and Other Displacements	Distinguishes and updates three types of movement, the Design Story Drift [Δ], the Design Earthquake Displacement [δ_{DE}], and the Maximum Considered Earthquake Displacement [δ_{MCE}].	Sections 11.2 , 11.3 , 12.8.6 , 12.12.1 , 12.12.3 , 12.12.4 , and 13.3.2	C12.8.6 , C12.12.4 , C12.12.5 , C13.3.2
$C_d = R$ for Deformation Compatibility	Sets C_d equal to R for the deformation compatibility check.	Section 12.12.5	C12.12.5

Topic of Change Proposals	Brief Summary of the Changes	Related or New Sections of ASCE/SEI 7-16	Related Commentary in ASCE/SEI 7-16
Coupled Analysis Requirement	Identifies components and systems that require seismic design, regardless of whether they are within or supported by a building or nonbuilding structure, or if they are supported on grade. It also updates the triggers when coupled analysis is required.	Sections 13.1.1 , 13.2.8 , 15.2 , 15.3.1 , 15.3.2 , and 15.3.3	C13.2.8 , C15.1.3 , C15.2 , C15.3.1 , C15.3.2 , and C15.1.3
Nonstructural Seismic Design Force Equations	Introduces significant revisions to the nonstructural seismic design force equations.	Sections 11.2 , 13.1.6 , 13.2.2 , 13.3.1 , 13.4.1 , 13.4.2 , 13.5.3 , 13.5.10 , 13.5.11 , and 13.6.4 , Tables 13.5-1 13.6-1	C13.3.1 , C13.4.1 , C13.4.2
Soil-Structure Interaction for Seismic Design	Adds values for the three new sites classes BC, CD, and DE (the three new site classes are introduced in Chapter 20).	Section 19.3 , Tables 19.3-1 , 19.3-2 and 19.3-3	C19.3
Multi-Period Response Spectra (MPRS)-Chapter 20	Introduces three new site classes to provide a more refined classification of site conditions and improve the accuracy of site amplification and associated values of seismic design parameters at longer response periods. Also links site classes to only \bar{v}_s .	Sections 20.1 , 20.2 , 20.3 and 20.4	C20.1 , C20.2 , C20.3 and C20.4
Multi-Period Response Spectra (MPRS)-Chapter 21	Incorporates MPRS into the site-specific requirements, revises lower-bound limits on site-specific response spectra and incorporates geotechnical recommendations. Also updates the deterministic MCE_R ground motion method.	Sections 21.1 , 21.2 , 21.3 , 21.4 and 21.5	C21.1 , 21.2 , 21.3 , 21.4 and 21.5
Multi-Period Response Spectra (MPRS)-Chapter 22	Replaces Figures of mapped values of parameters S_S , S_I , and PGA (for Site Class BC) with updated maps of S_{MS} , S_{MI} , and PGA_M for default site conditions and deletes Figures of mapped values of obsolete parameters C_{RS} and C_{R1} .	Chapter 22	C22

Volume II Part 3 of the 2020 *NEHRP Provisions* is a collection of resource papers that introduce new procedures or provisions not currently contained in the referenced standards for consideration and for trial use by the design community, researchers, and standards-development and code-development organizations. Part 3 also represents Issue Team efforts on substantive proposals for topics that require further consideration by the seismic design community and additional research before being considered for Parts 1 and 2 provisions. Part 3 consists of the following resource papers:

- Resilience-Based Design and the *NEHRP Provisions*
- Risk-Based Alternatives to Deterministic Ground Motion Caps
- Design of Isolated and Coupled Shear Walls of Concrete, Masonry, Structural Steel, Cold-Formed Steel and Wood
- Seismic Lateral Earth Pressures
- Seismic Design Story Drift Provisions – Current Questions and Needed Studies
- Diaphragm Design Force Reduction Factor, R_s , for Composite Concrete on Metal Deck Diaphragms
- Development of Diaphragm Design Force Reduction Factors, R_s
- Calculation of Diaphragm Deflections Under Seismic Loading
- Modal Response Spectrum Analysis Methods

As part of its efforts to regularly update the *NEHRP Recommended Seismic Provisions*, the BSSC also works with its PUC, Member Organizations, and general membership to identify and recommend issues to be addressed and research needed to advance the state of the art of earthquake-resistant design and to serve as the basis for future refinement of the Provisions. This future issues and research needs report will be published separately by FEMA and BSSC.

Page intentionally left blank.

2020 NEHRP RECOMMENDED SEISMIC PROVISIONS FOR NEW BUILDINGS AND OTHER STRUCTURES:

INTENT

This chapter on the Intent of the 2020 Provisions describes the expected seismic performance that is judged to be inherent in the seismic requirements in Parts 1 and 2.

1.1 INTENT

The *NEHRP Recommended Seismic Provisions for New Buildings and Other Structures* presents the minimum recommended requirements necessary for the design and construction of new buildings and other structures to resist earthquake ground motions throughout the United States. The objectives of these provisions are to provide reasonable assurance of seismic performance that will:

1. Avoid serious injury and life loss due to
 - a. Structure collapse
 - b. Failure of nonstructural components or systems
 - c. Release of hazardous materials
2. Preserve means of egress
3. Avoid loss of essential functions in critical facilities, and
4. Reduce structural and nonstructural repair costs where practicable.

These performance objectives do not all have the same likelihood of being achieved. Additional detail on the objectives is provided in section 1.1.1 through 1.1.6.

The degree to which these objectives can be achieved depends on a number of factors including structural framing type, building configuration, structural and nonstructural materials and details, and overall quality of design and construction. In addition, large uncertainties as to the intensity and duration of shaking and the possibility of unfavorable response of a small subset of buildings or other structures may prevent full realization of these objectives.

1.1.1 Structure Collapse

For objective 1.a the *Provisions* target performance such that the probability of collapse of a significant portion or all of an ordinary use (Risk Category II¹) structure due to earthquake ground shaking does not exceed 10% given the occurrence of a very rare ground motion. For nearly all of the country, the very rare ground motion is computed such that for structures that have the typical collapse fragility when subjected to various seismic ground motions, there is an overall 1% chance of collapse in 50 years due to earthquake ground shaking. The combination of these two probabilities defines the “Risk Targeted Maximum Considered Earthquake Ground Motion (MCE_R).” There are areas near faults that produce frequent, large

¹ Where the Risk Category is defined in Section 1.5 of ASCE/SEI 7-16

earthquakes where the MCE_R ground shaking is not computed on the basis of the 1% in 50-year target, because that probabilistic computation produces extremely large ground motions. In such areas the MCE_R ground shaking is determined by assuming that a characteristic earthquake for that fault does occur and then computing the ground motion attenuation from the fault to the site at the 84th percentile level.

Objective 1.a is adjusted, using importance factors, to target a higher reliability against collapse for structures in higher Risk Categories¹, such as those housing a function essential to the response of a community following a disastrous event, large or less capable populations, or hazardous materials. There are additional performance goals for some of these types of structures, addressed in the following sections, and those other goals may govern the design. Roughly, these adjustments in the risk target reduce by half the probability of collapse for each incremental increase in the Risk Category. This adjustment applies to the conditional probability of collapse given the occurrence of the MCE_R ground motion. The probabilities of collapse in 50 years also change in a similar fashion, but there will be some difference from site to site based upon the nature of the seismic ground motion hazard. The maximum probabilities of collapse for buildings or other structures designed to the requirements of the four risk categories are targeted as follows:

Risk Category ¹	Probability of Collapse	
	Given MCE_R Shaking	In 50 years*
I	**	**
II	10%	1%
III	5%	less than 1%
IV	2.5%	less than 1%

*The probability of collapse in 50 years is larger in areas where the MCE_R ground motion is computed from a deterministic assumption of earthquake occurrence.

**Most Risk Category I structures are designed for the same requirement as Risk Category II, while some are exempted from any seismic design requirement.

The basic recommendation for Risk Category II structures is based upon acceptance of substantial damage at the MCE_R ground motion and lesser damage at lesser ground motions.

The *Provisions* employ a system of Seismic Design Categories to apply various requirements for more rigorous design methods, construction details, and limitations on materials and systems. The category depends on the MCE_R ground motion at the specific site and the Risk Category of the structure. The MCE_R ground motion is defined to include modifications for ground conditions at the specific site.

In addition to global collapse of the structure, individual structural elements that are not critical to the global stability of the structure have a maximum conditional probability of failure against failure as follows:

Risk Category ¹	Conditional Probability of Failure for Member or Connection	
	Given DE Shaking	Given MCE_R Shaking
I	**	**
II	10%	25%
III	5%	15%
IV	2.5%	9%

**Most Risk Category I structures are designed for the same requirement as Risk Category II, while some are exempted from any seismic design requirement.

Seismic Design Category A is the lowest category. No seismic design requirements are applied for Category A. It is defined to be those sites where the MCE_R ground motion is less than half that associated with structural damage in historical earthquakes, regardless of Risk Category.

1.1.2 Nonstructural Damage

For objective 1.b the *Provisions* recommend that structures and selected nonstructural components be designed and built to prevent failures of nonstructural components or systems, where such failures would endanger life. The criterion is based on less severe and more frequent ground shaking than used for protection against structure collapse. Based on historic precedent, this level of ground motion is taken as two-thirds of the MCE_R ground motion. It is termed the design earthquake ground motion, or DE ground motion.

For components that pose a life safety threat due to their weight and position, the fundamental requirement is to maintain the position of the component through anchorage, bracing, and strength. Observations of damage to some unbraced and unanchored components in past earthquakes suggest that life threatening damage is unlikely under moderate ground motions, while other components such as parapets and other appendages still pose a significant risk. Thus the scope of components to consider is substantially less in the seismic design categories where the ground shaking demand is moderate. Through the use of a component importance factor to require greater strength and displacement capacity, the probability of failure given the DE ground motion is reduced for components that are necessary for life safety immediately following a strong earthquake, such as fire suppression systems and egress stairways. In addition to requirements for bracing and anchorage, equipment assigned the high component importance factor must be qualified through testing, experience data, or analysis to assure continuous operation when subject to the DE ground motion. Performance of nonstructural components is also influenced by the requirements for a minimum lateral stiffness (drift limits) for structural systems and requirements that nonstructural systems accommodate the anticipated structural drift; the stiffness requirement is more restrictive for higher Risk Categories.

1.1.3 Hazardous Materials

For objective 1.c the *Provisions* target structures to be designed and built to prevent failure of structural or nonstructural components or systems that would release unacceptable quantities of hazardous materials. For buildings and nonbuilding structures the performance target is adjusted for the Risk Category just as it is for the collapse objective (1.1.1). For nonstructural components, the performance target is adjusted with component importance factors, and the basis is the DE. For Risk Categories III and IV the objective is to provide a likelihood of major release of hazardous materials that is very low at the DE ground motion and thus low at the MCE_R ground motion. For nonstructural components the amount of inelastic behavior permitted at strong ground motions is adjusted with the component importance factor. For nonbuilding structures the protection from major releases may include secondary containment.

1.1.4 Preservation of Egress

For Objective 2 the *Provisions* intend that stairs be designed and built to be functional following the DE ground motion. The component importance factor is intended to provide a low likelihood that stairs lose support due to seismic displacements.

1.1.5 Functionality of Critical or Essential Facilities

For Objective 3 the *Provisions* intend to have a high probability of avoiding earthquake-induced loss of essential functionality for Risk Category IV structures when subjected to the design earthquake (DE) shaking intensity. The definition of essential functions shall be left to the determination of the owner or operator of the facility, the governing building code, or the authority having jurisdiction. In addition, the *Provisions* include some requirements to increase the likelihood that function be maintained for nonstructural components and systems at the DE ground motion. To help achieve these goals, permissible story drifts are reduced to control damage to nonstructural components connected to multiple floor levels. Nonstructural system performance is enhanced by strengthening the anchorage and bracing requirements for components necessary for functionality of the facility, and by requiring that important equipment and

associated systems be shown to be functional after being shaken. The expectation is that functionality will usually be maintained at ground motions comparable to the motion used for design of nonstructural elements (the DE ground motion); however, given the state of knowledge for predicting such performance, the probability of meeting that expectation is not specified.

For buildings, the following qualitative characteristics define this performance objective when subjected to the design earthquake shaking intensity:

1. Remains safe for continued occupancy.
2. Equipment required for the essential functions of the building functions after the event.
3. Contents required for the essential functions of the facility have not been damaged.
4. Nonessential equipment and contents may sustain damage, provided that the damage does not compromise the essential functions of the building.
5. The building envelope maintains integrity where required to preserve essential functions.
6. Piping carrying nontoxic substances have only minor leakage.
7. Toxic and Highly toxic substances are not released in a quantity harmful to occupants unless controlled through secondary containment.
8. Egress is maintained.

For nonbuilding structures, the following qualitative characteristics define this performance objective when subjected to the design earthquake shaking intensity:

1. Release of contents essential to the function of the facility is prevented.
2. Equipment required for essential function of the nonbuilding structure functions after the event.
3. Contents required to fulfill the essential functions of the facility have not been damaged.
4. Nonessential equipment and contents may sustain damage, provided that the damage does not compromise the essential functions of the nonbuilding structure.
5. Piping carrying nontoxic substances have only minor leakage.
6. Toxic and Highly toxic substances are not released in a quantity harmful to occupants unless controlled through secondary containment.
7. Access required for essential functions of the nonbuilding structure is preserved after the event.
8. Egress from the nonbuilding structure is maintained.

1.1.6 Repair Costs

Objective 4 is primarily aimed at those nonstructural elements for which seismic anchorage and bracing are both low cost and effective in reducing economic losses in ground motions that are smaller and more frequent than the motions used for life safety. There are also provisions in various material design standards that aim to provide additional resistance for certain structural failure states that are not particularly threatening to life, but are very expensive to repair.

2.1 COMMENTARY TO THE INTENT

The primary intent of the *NEHRP Recommended Seismic Provisions for New Buildings and Other Structures* is to prevent, for ordinary buildings and structures, serious injury and life loss caused by damage from earthquake ground shaking and ground failure. Most earthquake injuries and deaths are caused by structural collapse; therefore, the major thrust of the Provisions is to prevent collapse for very rare, intense ground motion, termed the risk targeted maximum considered earthquake (MCE_R) ground motion. Additional objectives to preserve means of egress, maintain functionality of critical or essential facilities

following major earthquakes, and to reduce damage costs, where practicable, are addressed as corollaries to the primary intent.

The *Provisions* requirements are not intended to prevent damage due to landslides (such as those that occurred in Anchorage, Alaska) or tsunami (such as occurred in Hilo, Hawaii, the Indian Ocean, and Japan). They provide only for required resistance to earthquake ground shaking and movements due to liquefaction without significant slides, subsidence, or faulting in the immediate vicinity of the structure. In most cases, practical engineering solutions are available to resist other potential earthquake hazards, but they must be developed on a case-by-case basis. The *Provisions* do require geotechnical investigations for sites where such instabilities are possible, and the geotechnical reports must recommend appropriate mitigation.

Although the *Provisions* sets the minimum performance goals described in Section 1.1, earthquake performance of buildings and other structures is highly variable. The characteristics of the shaking itself are highly uncertain and even different ground motion records defined to qualify as maximum considered earthquake ground motions for the same target spectrum can result in significantly different responses. Additional uncertainty is created by the wide variety of systems and configurations allowed under the regulations as well as by the various interpretations and implementation practices of individual designers. Thus, a small percentage of buildings designed to the requirements of the *Provisions* may not meet the performance intent when exposed to earthquake ground motions. The commentary of the *Tentative Provisions for the Development of Seismic Regulations for Buildings* (Applied Technology Council, 1978), upon which the first edition of the *NEHRP Recommended Provisions* (1985) was based, suggested a less than 1% chance of collapse in a 50-year period for a building designed using the tentative requirements. More recent studies (e.g., *Quantification of Building Seismic Performance Factors*, FEMA P-695, 2009) suggest a 10% chance of collapse with shaking at the maximum considered earthquake level, which is roughly equivalent to the 1978 estimations.

In the future it is possible that the risk targeting concepts implemented for the structural collapse objective may be applied to other objectives, using methods such as described in *Tentative Framework for Advanced Seismic Design Criteria for New Building* (NIST, 2012). More knowledge of seismic performance of constructed systems is needed to accomplish this.

2.1.1 Structure Collapse

The primary objective regarding collapse has remained the same since the 1997 edition of the *Provisions*; however, the quantification was not added until the 2009 edition when the prevention of collapse was redefined in terms of risk-targeted maximum considered earthquake (MCE_R) ground motions. A building deemed to have higher importance due to hazardous contents or critical occupancy is assigned to a higher Risk Category (see ASCE/SEI 7-16, Table 1.5-1). The damage level in such buildings is intended to be reduced by decreasing nonlinear demand using an importance factor, I , to reduce the response modification coefficient, R . The resulting increased strength will reduce structural damage, and increase reliability of acceptable performance, for a given level of shaking. Some authorities having jurisdiction subject the design and construction of such buildings to a higher level of scrutiny to reduce uncertainties associated with design or construction error.

The amplitude of the MCE_R shaking, except where the deterministic limit applies, generally is somewhat less than a ground motion hazard having a probability of 2% of being exceeded in 50 years. The deterministic limit is imposed on the MCE_R ground motion, because the large uncertainty in our ability to predict ground motion at a site, given an earthquake of known magnitude at a known location, drives the probabilistic computation to predict very large ground motions where the return period of the characteristic earthquake is only a small fraction of the return period of interest for failure. The alternative calculation effectively places a bound on that uncertainty in ground motion while preserving the occurrence of a rare and large earthquake at a known location with some conservatism in the prediction of ground motion for that event as the design basis. Compared to less seismically active regions where earthquake records are rare, there is much more data available on the likely magnitude of earthquakes that active faults in such

regions are capable of generating. It is also true that very large ground motions make some types of construction economically impractical, and there is insufficient experience to validate that design for such extreme ground motions without the deterministic limit is necessary.

The risk target of a 1% chance of collapse in 50 years is roughly an order of magnitude higher than the chance of failure of structural elements subject to combinations of conventional loads without earthquake, in large part because the cost of providing seismic protection is substantial in high hazard locations. These probabilities are meaningful when computed with the carefully constrained methodologies (FEMA, 2009 and Luco, 2007) used in developing the probabilities cited here and are not intended to imply that the actual failure rates will be that large or that such failure rates would be considered acceptable. It is believed the real rates are lower because

1. historical damage statistics would support better performance
2. the beneficial effect of the gravity load framing is ignored in establishing the seismic response modification factor (the R factor),
3. conservative assumptions on uncertainties are included in the analysis of the seismic hazard and the structural performance, and
4. on the average, structures are not actually designed at the limit of the design criterion

The constraints are intended to permit rational comparison of differing probabilities for differing circumstances.

The provisions also seek to protect against local failure that does not result in global collapse but could result in injury risk to a few persons. Local failure is prevented by prescriptive provisions in Chapter 12 and explicit design provisions in Chapter 16. Chapter 12 requires structural design for vertical seismic effects and deformation compatibility for members that are not part of the seismic force-resisting system to prevent local failures. Chapter 16 defines structural elements according to their criticality as critical, ordinary and noncritical, where critical elements can lead to global collapse; ordinary elements to endangerment to a limited number of lives; and noncritical elements, which do not have safety consequences. For ordinary elements in Risk Category II structures, the standard is based on a 25% probability of failure given MCE_R shaking. Assuming the DE is 67% of the MCE_R , that correlates to approximately 10% probability of failure for DE shaking. Failure probabilities for ordinary elements in Risk Category III and IV structures are respectively 15% and 10% for MCE_R shaking and 45% and 2.5% for DE shaking.

The ground motion level below which seismic design is not required is established at a conservatively low level in part to recognize the lower confidence of knowledge of seismic hazards in such areas, but also to address this discrepancy in risk under other loadings in an approximate fashion. In other words, given the variation in ground shaking hazard with probability of exceedance in the pertinent range of probabilities, the risk of collapse due to seismic action should be well under the 1% in 50 years target near the transition in hazard level from Seismic Design Category A to B. The transition in risk of collapse to the target of 1% in 50 years where the MCE_R motions are higher is not yet well understood.

2.1.2 Nonstructural Damage

Falling exterior walls and cladding and falling interior ceilings, light fixtures, pipes, equipment, and other nonstructural components also cause deaths and injuries, as well as loss of function. The *Provisions* minimizes this risk using requirements for anchoring and bracing nonstructural components. In the future it may be possible to target this objective to a specific risk, but at this time the level of protection is set at two-thirds of the MCE_R ground motion in part because that level is roughly the same as the level used for design in Coastal California before the criterion for structure collapse was defined at the MCE_R ground motion. The level of ground motion of two-thirds of the MCE_R ground motion is referred to as the Design Earthquake ground motion; the probability of that level of ground motion occurring varies with location. Another complicating factor in understanding the level of risk surrounding nonstructural failures is that the

demand on nonstructural components would vary with the amount of actual yielding in the structural response to ground shaking, but it is currently not possible to provide for that in any design procedure based upon linear response analysis methods.

The component importance factor is used to reduce the probability of failure of nonstructural components or systems that create a risk to life stemming from loss of their function immediately following the earthquake, such as the failure of the fire suppression system, rather than risks posed by the component from its weight and position. The uncertainty in performance would be similar to the uncertainty in structural collapse, because the overall uncertainty is dominated by variations in ground motion and dynamic response of both the structure and the component, therefore the risk of failure of such components is likely reduced but the degree cannot be stated at this time.

2.1.3 Hazardous Materials

Hazardous materials can be released by a structural and nonstructural failure, however such failures can occur short of collapse. The expectation is that the probability of catastrophic release of such materials across a facility boundary would be similar to the probability of structure collapse for ordinary structures, although more study will be needed to validate that any target is indeed met by the recommended provisions. Release within a facility where relatively fewer lives are at risk would be less rare, although no specific target exists at this time. There is a lack of data, especially regarding the performance of nonstructural systems under strong ground shaking that makes quantification of the objective impossible without further study. Refer to the commentary for Section 1.5.3 of ASCE/SEI 7-16 for the quantitative definition of toxic, highly toxic, and explosive categories of hazardous materials.

2.1.4 Preservation of Egress

In the 2015 *Provisions* preservation of egress was identified as a distinct objective. At this time the specific requirements are focused on deformation compatibility of stairs and ramps.

2.1.5 Functionality of Critical or Essential Facilities

This section describes qualitatively the intended performance of Risk Category IV buildings and other structures designed to the *Provisions* with respect to preservation of critical functions. The *Provisions* intent is that Risk Category IV buildings and other structures have a high probability of resuming their essential functions following the design earthquake. The qualifier of “essential” on functions and functionality is present because it is recognized that following design earthquake level shaking the nonessential functions of the facility may be impaired, but that the most important functions the facility performs can still be accomplished. Moderate damage to components and contents not essential to the function of the facility may occur, but must not compromise the functionality of essential components. Cleanup and minor repairs, which can be carried out while the facility is operating, may be required.

It is important to realize that functionality does not imply an absence of damage, or even function as it would be under ordinary circumstances before an earthquake. Experience has shown that extensive workaround solutions are made to respond to damage in essential facilities so that some level of function is maintained, however such solutions are not the goal of the *Provisions*. More work is necessary to improve standards so that functional performance is achieved when desired for all structural systems and for nonstructural components and their systems. Some analytical studies (ATC, 2018) have shown that the probability of an unsafe placard and damage likelihood is not uniform for all structural systems, and some with potentially unacceptable results. The functionality objective for Risk Category IV will often control the structural design over the collapse objective. The performance of critical occupancy structures in past earthquakes indicates that the increase in the importance factor and more stringent story drift limits, in combination with strict regulation of design, testing, and inspection, reduces structural damage in moderate shaking. Experience data show that some nonstructural components will remain functional if they stay in position, but other components will require testing to show that they will function following strong shaking.

The emphasis to date has been on the seismic qualification of individual components and analysis of individual systems. However, the nonstructural systems of many buildings are, in reality, complex networks that can be shut down by a single failure. For example, a break in a pressurized pipe can flood a critical area of the facility, or if not quickly isolated, all of a building, forcing it to close, and failure of the anchorage (or internal workings) of a battery, day tank, fuel lines, muffler, or main engine can shut down an emergency generator. Therefore, the special regulations for seismic protection of nonstructural systems represent a rational approach to achieving performance appropriate for the various occupancies, but experience data to confirm their adequacy are lacking.

The Provisions include some requirements to increase the likelihood that function be maintained for nonstructural components and systems at the DE ground motion. To achieve these goals, permissible story drifts are reduced in the *Provisions* to control damage to structural components and nonstructural components connected to multiple floor levels. Nonstructural system performance is enhanced by strengthening the anchorage and bracing requirements for components necessary for functionality of the facility, and by requiring that equipment required for the function of the facility and associated systems be shown to be functional after being shaken through direct testing or detailed analysis. The expectation is that functionality will usually be maintained at ground motions comparable to the motion used for design of nonstructural elements (the DE ground motion); however, given the state of knowledge for predicting such performance, the probability of meeting that expectation is not specified and may not be consistent for all structural systems and configurations.

The intent dictates a high probability of preventing loss of function, but does not explicitly state a reliability target. A desired target reliability for Risk Category IV buildings and nonbuilding structures is for there to be a 10% probability of loss of essential function given the Design Earthquake ground motion. Observations from past earthquakes has shown that the performance of many structural systems, particularly those used in nonbuilding structures, will meet or exceed this goal. However, it may be difficult to demonstrate so analytically. Many nonbuilding structures designed to modern codes performed well in the Chile Earthquake of 2010 (Soules, Bachman, Silva 2016). Ground supported tanks and pressure vessels did not release their contents even though the measured ground motions were in excess of the design level event. Steel and concrete stacks and a recently completed bar mill building were completely undamaged during the Chile event.

2.1.6 Repair Costs

The requirements for anchoring and bracing of nonstructural components and systems coupled with reasonable limitations on differential movement between floors (i.e., story drift limits) may serve to control damage that may be costly to repair or that would result in lengthy building closures, particularly for moderate shaking levels. This level of economic protection will vary across different types of structural and nonstructural systems, and no specific target has been established, nor is there a consensus among stakeholders as to the appropriate levels of protection. Nonstructural designs for story drift that focus on limiting damage to the component or system rather than only preventing catastrophic failure are much more effective at reducing economic losses.

Stricter story drift limits can further limit damage to components connected to more than one floor (e.g., walls, cladding and stairways) but, at the same time, can create higher acceleration levels in the building that could increase damage to nonstructural components braced or anchored to a single floor (e.g., ceilings, light fixtures, and pipes). Achieving an optimum balance between the cost and performance of the structural system and the effect of structural stiffness on performance of the nonstructural systems is not accomplished using the prescriptive rules of a building code, particularly given the variety of structural systems used in the United States.

Examples of provisions with a primary focus of damage control, rather than life safety, include bracing of lightweight ceiling systems, limitations on punching shear in concrete flat slabs (in the design standard for concrete structures), and limitations on interstory drift for masonry walls.

REFERENCES

- FEMA, 2009, “Quantification of building seismic performance factors,” *FEMA P-695*, prepared by Applied Technology Council for Federal Emergency Management Agency, Washington, DC.
- FEMA, 2018a, “Seismic performance assessment of buildings, Volume 1 – Methodology, Second Edition,” *FEMA P-58-1*, prepared by the Applied Technology Council for the Federal Emergency Management Agency, Washington, D.C.
- FEMA, 2018b, “Seismic performance assessment of buildings, Volume 2 – Implementation guide, Second Edition,” *FEMA P-58-2*, prepared by the Applied Technology Council for the Federal Emergency Management Agency, Washington, D.C.
- FEMA, 2018c, “Seismic performance assessment of buildings, Volume 3 – Supporting electronic materials and background documentation, Second Edition,” *FEMA P-58-3*, prepared by the Applied Technology Council for the Federal Emergency Management Agency, Washington, D.C.
- FEMA, 2018d, “Seismic performance assessment of buildings, Volume 5 – Expected seismic performance of code-conforming buildings,” *FEMA P-58-5*, prepared by the Applied Technology Council for the Federal Emergency Management Agency, Washington, D.C.
- FEMA, 2018e, “Guidelines for performance-based seismic design of buildings,” *FEMA P-58-6*, prepared by the Applied Technology Council for the Federal Emergency Management Agency, Washington, D.C.
- FEMA, 2018f, “Building the performance you need, a guide to state-of-the-art tools for seismic design and assessment,” *FEMA P-58-7*, prepared by the Applied Technology Council for the Federal Emergency Management Agency, Washington, D.C.
- FEMA, 2012, “Seismic performance assessment of buildings, Volume 4 – Methodology for assessing environmental impacts,” *FEMA P-58-4*, prepared by the Applied Technology Council for the Federal Emergency Management Agency, Washington, D.C.
- Luco, N., et al., 2007, *Risk-targeted versus current seismic design maps for the coterminous United States*, Proceedings, SEAOC 76th Annual Convention, Structural Engineers Association of California, Sacramento, CA.
- NIST, 2012, “Tentative framework for development of advanced seismic design criteria for new buildings,” NEHRP Consultants Joint Venture, *NIST GCR 12-917-20*, National Institute of Standards and Technology, Gaithersburg, MD
- Soules, J. G., Bachman, R.E., and Silva, J.F., *Chile Earthquake of 2010 – Assessment of industrial facilities around concepción*, American Society of Civil Engineers, Structural Engineering Institute, Reston, VA, 2016

REFERENCE DOCUMENT

Design for seismic resistance of structural elements including foundation elements and nonstructural components shall conform to the requirements of ASCE/SEI 7-16, *Minimum Design Loads for Buildings and Other Structures*, including Supplement No. 1 (referred to hereinafter as ASCE/SEI 7-16), as modified herein.

2020 NEHRP RECOMMENDED SEISMIC PROVISIONS FOR NEW BUILDINGS AND OTHER STRUCTURES:

PART 1, PROVISIONS

MODIFICATIONS TO ASCE/SEI 7-16, CHAPTERS 11-22

Part 1 Provisions provides recommended changes to the seismic requirements of ASCE/SEI 7-16, Chapters 11 to 22. For a given chapter, only those sections with recommended modifications or additions are shown. Therefore, the Provisions Part 1 should be used side-by-side with ASCE 7-16 in order to grasp the full context of each chapter.

CHAPTER 11, SEISMIC DESIGN CRITERIA (Modifications)

SECTION 11.2 DEFINITIONS

Add the following definitions to Section 11.2:

DESIGN EARTHQUAKE DISPLACEMENT: See “displacement and drift.”

DESIGN STORY DRIFT: See “displacement and drift.”

DISTRIBUTION SYSTEM: An interconnected system composed primarily of linear components including piping, tubing, conduit, raceways, and ducts. Distribution systems include in-line components such as valves, in-line suspended pumps, and mixing boxes.

DISPLACEMENT AND DRIFT

DESIGN EARTHQUAKE DISPLACEMENT: The displacement at a given location of the structure corresponding to the Design Earthquake.

DESIGN STORY DRIFT: The story drift corresponding to the Design Earthquake, taken at a representative location (center of mass or building perimeter, as required by Section 12.8.6).

MAXIMUM CONSIDERED EARTHQUAKE DISPLACEMENT: The displacement at a given location of the structure corresponding to the Risk-Targeted Maximum Considered Earthquake (MCE_R).

STORY DRIFT: The horizontal displacement at the top of the story relative to the bottom of the story at a given location.

STORY DRIFT RATIO: The story drift divided by the story height, h_{sx} .

EQUIPMENT SUPPORT: Those structural members or assemblies of members or manufactured elements, including braces, frames, legs, lugs, snubbers, hangers, or saddles, that transmit gravity loads and operating loads between the equipment and the structure.

Equipment Support Structure: Assemblies of members or manufactured elements other than integral supports, including moment frames, braced frames, skids, legs greater than 24 inches (600 mm) in length, or walls that support a nonstructural component or system.

Distribution System Support: Hangers, vertical supports, and bracing members that provide vertical or lateral seismic resistance for distribution systems, including hangers, braces, pipe racks, and trapeze assemblies.

Equipment Support, Integral: Supports and their associated attachments and base plates that provide vertical or lateral support for nonstructural components and are directly connected to both the nonstructural component and the attachment to the structure or foundation, including lugs, skirts, saddles, or legs less than or equal to 24 inches (600 mm) in length, and where the nonstructural component acts as part of the lateral force-resisting system of the equipment support.

Equipment Support Platform: Assemblies of structural members or manufactured elements including moment frames and braced frames that support multiple nonstructural components or systems.

REINFORCED CONCRETE DUCTILE COUPLED WALL: A seismic force-resisting system with a minimum height of 60 feet as defined in ACI 318-19 Section 2.3 and complying with ACI 318-19 Section 18.10.9.

STORY DRIFT: See “displacement and drift.”

USGS SEISMIC DESIGN GEODATABASE: The United States Geological Survey (USGS) database of geocoded values of seismic design parameters S_S , S_I , S_{MS} , S_{MI} , and PGA_M and geocoded sets of multi-period 5%-damped risk-targeted maximum considered earthquake (MCE_R) response spectra.

User Note: The USGS Seismic Design Geodatabase is intended to be accessed through a USGS Seismic Design Web Service that allows the user to specify the site location, by latitude and longitude, and the site class to obtain the seismic design data. The USGS web service spatially interpolates between the gridded data of the USGS geodatabase. Both the USGS geodatabase and the USGS web service can be accessed at <https://doi.org/10.5066/F7NK3C76>. A web interface <https://www.wbdg.org/additional-resources/tools/bssc2020nehrp> is provided by the BSSC for users to access the USGS web service, including determination of the Seismic Design Category (SDC) at any specified location.

SECTION 11.3 SYMBOLS

Add and revise the following symbols:

C_{AR} = component resonance ductility factor that converts the peak floor or ground acceleration into the peak component acceleration as determined in Section 13.3.1.3;

$C_{d-diaph}$ = deflection amplification factor for diaphragm deflection (12.10.4).

$C_{s-diaph}$ = seismic response coefficient for design of diaphragms using the alternative diaphragm design method of Section 12.10.4.

H_f = factor for force amplification as a function of height in the structure as determined in Section 13.3.1.1;

L_{diaph} = the span in feet of the horizontal diaphragm or diaphragm segment being considered, measured between vertical elements or collectors that provide support to the diaphragm or diaphragm segment (12.10.4).

PGA_G = lower-bound limit on deterministic maximum considered earthquake geometric mean peak ground acceleration, Table 21.2-1

PGA_M = mapped MCE_G peak ground acceleration as defined in Section 11.8.3.

R_{diaph} = response modification coefficient for design of diaphragms using the alternative diaphragm design method of Section 12.10.4.

R_μ = structure ductility reduction factor as determined in Section 13.3.1.2;

R_{po} = component strength factor as determined in Section 13.3.1.4

S_I = the MCE_R , 5% damped, spectral response acceleration parameter at a period of 1 s for Site Class BC site conditions as defined in Section 11.4.3

S_a = the 5% damped design spectral response acceleration parameter at any period as defined in Section 11.4.5

S_{aM} = the site-specific, 5% damped, MCE_R spectral response acceleration parameter at any period

S_{D1} = the design, 5% damped, spectral response acceleration parameter at a period of 1 s as defined in Section 11.4.4

S_{DS} = the design, 5% damped, spectral response acceleration parameter at short periods as defined in Section 11.4.4

S_{M1} = the MCE_R , 5% damped, spectral response acceleration parameter at a period of 1 s as defined in Section 11.4.3

S_{MS} = the MCE_R , 5% damped, spectral response acceleration parameter at short periods as defined in Section 11.4.3

S_S = the MCE_R , 5% damped, spectral response acceleration parameter at a period of 0.2 s for Site Class BC site conditions as defined in Section 11.4.3

T_{diaph} = period of diaphragm for design of diaphragm using the alternative diaphragm design method of Section 12.10.4

T_L = long-period transition period shown in Figs. 22-14 through 22-17

= design story drift as determined in Section 12.8.6

δ_{DE} = Design Earthquake Displacement as determined in Section 12.8.6.

δ_{MCE} = Maximum Considered Earthquake Displacement as determined in Section 12.8.6.

$\Omega_{o-diaph}$ = diaphragm overstrength factor (12.10.4)

Ω_{op} = anchorage overstrength factor for nonstructural components (13.4.1).

Delete the following symbols:

a_p = the amplification factor related to the response of a system or component as affected by the type of seismic attachment, determined in Section 13.3.1

C_R = site-specific risk coefficient at any period (Section 21.2.1.1)

C_{R1} = mapped value of the risk coefficient at a period of 1 s as given by Figure 22-19

C_{RS} = mapped value of the risk coefficient at short periods as given by Figure 22-18

F_a = short-period site coefficient (at 0.2-s period); see Section 11.4.4

F_{PGA} = site coefficient for peak ground acceleration (PGA); see Section 11.8.3

F_v = long-period site coefficient (at 1.0-s period); see Section 11.4.4

PGA = mapped MCE_G peak ground acceleration shown in Figs. 22-9 through 22-13

R_p = component response modification factor as defined in Section 13.3.1

SECTION 11.4 SEISMIC GROUND MOTION VALUES

Replace Section 11.4 with the following:

11.4.1 Near-fault sites

Sites satisfying either of the following conditions shall be classified as near fault:

1. 9.5 miles (15 km) or less from the surface projection of a known active fault capable of producing M_w 7 or larger events, or
2. 6.25 miles (10 km) or less from the surface projection of a known active fault capable of producing M_w 6 or larger events.

EXCEPTIONS:

1. Faults with estimated slip rate less than 0.04 in. (1 mm) per year shall not be considered in determining whether a site is a near-fault site.
2. The surface projection used in the determination of near-fault site classification shall not include portions of the fault at depths of 6.25 mi (10 km) or greater.

11.4.2 Site Class

The site shall be classified as Site Class A, B, BC, C, CD, D, DE, E, or F in accordance with Chapter 20.

11.4.2.1 Default Site Class

Where the soil properties are not known in sufficient detail to determine the site class, risk-targeted maximum considered earthquake (MCE_R) spectral response accelerations shall be based on the most critical spectral response acceleration of Site Class C, Site Class CD and Site Class D, unless the authority having jurisdiction determines, based on geotechnical data, that Site Class DE, E or F soils are present at the site.

11.4.3 Risk-Targeted Maximum Considered Earthquake (MCE_R) Spectral Response Acceleration Parameters

Risk-targeted maximum considered earthquake (MCE_R) spectral response acceleration parameters S_S , S_I , S_{MS} and S_{MI} shall be obtained from the USGS Seismic Design Geodatabase <https://doi.org/10.5066/F7NK3C76>. Values of these parameters are provided by the USGS Seismic Design Web Service for the site class determined in accordance with Section 11.4.2.

EXCEPTION: Where a site-specific ground motion analysis is performed in accordance with Section 11.4.7, risk-targeted maximum considered earthquake (MCE_R) spectral response acceleration parameters S_{MS} and S_{MI} shall be determined in accordance with Section 21.4 and risk-targeted maximum considered earthquake (MCE_R) spectral response acceleration parameters S_S and S_I shall be determined from the site-specific MCE_R response spectrum of Section 21.2.3.

11.4.4 Design Spectral Acceleration Parameters

Design earthquake spectral response acceleration parameters at short periods, S_{DS} , and at a 1-s period, S_{D1} , shall be determined from Eqs. (11.4-1) and (11.4-2), respectively. Where the alternate simplified design procedure of Section 12.14 is used, the value of S_{DS} shall be determined in accordance with Section 12.14.8.1, and the value for S_{D1} need not be determined.

$$S_{DS} = \frac{2}{3} S_{MS} \quad (11.4-1)$$

$$S_{D1} = \frac{2}{3} S_{M1} \quad (11.4-2)$$

Where

S_{MS} = the 5% damped MCE_R spectral response acceleration parameter at short periods as determined in accordance with Section 11.4.3, and

S_{M1} = the 5% damped MCE_R spectral response acceleration parameter at a period of 1 s as determined in accordance with Section 11.4.3.

11.4.5 Design Response Spectrum

Where a design response spectrum is required by this standard, the design response spectrum shall be determined in accordance with the requirements of Section 11.4.5.1.

EXCEPTIONS:

1. Where a site-specific ground motion analysis is performed in accordance with Section 11.4.7, the design response spectrum shall be determined in accordance with Section 21.3.
2. Where values of the multi-period 5%-damped MCE_R response spectrum are not available from the USGS Seismic Design Geodatabase, the design response spectrum shall be permitted to be determined in accordance with Section 11.4.5.2.

11.4.5.1 Multi-Period Design Response Spectrum

The multi-period design response spectrum shall be developed as follows:

1. At discrete values of period, T , equal to 0.0 s, 0.01 s, 0.02 s, 0.03 s, 0.05 s, 0.075 s, 0.1 s, 0.15 s, 0.2 s, 0.25 s, 0.3 s, 0.4 s, 0.5 s, 0.75 s, 1.0 s, 1.5 s, 2.0 s, 3.0 s, 4.0 s, 5.0 s, 7.5 s and 10 s, the 5%-damped design spectral response acceleration, S_a , shall be taken as two-thirds of the multi-period 5%-damped MCE_R response spectrum of the USGS Seismic Design Geodatabase <https://doi.org/10.5066/F7NK3C76>. Values of these parameters are provided by the USGS Seismic Design Web Service for the site class determined in accordance with Section 11.4.2.
2. At each response period, T , less than 10 s and not equal to one of the discrete values of period, T , listed in Item 1 above, S_a , shall be determined by linear interpolation between values of S_a , of Item 1 above.
3. At each response period, T , greater than 10 s, S_a , shall be taken as the value of S_a at the period of 10 s of Item 1 above, factored by $10/T$, where the value of T is less than or equal to that of the long-period transition period, T_L , and shall be taken as the value of S_a at the period of 10 s factored by $10T_L/T^2$, where the value of T is greater than that of the long-period transition period, T_L .

11.4.5.2 Two-Period Design Response Spectrum

The two-period design response spectrum shall be developed as indicated in Figure 11.4-1 and as follows:

1. For periods less than T_0 , the design spectral response acceleration, S_a , shall be taken as given in Eq. (11.4-3):

$$S_a = S_{DS} \left(0.4 + 0.6 \frac{T}{T_0} \right) \quad (11.4-3)$$

2. For periods greater than or equal to T_0 and less than or equal to T_s , the design spectral response acceleration, S_a , shall be taken as equal to S_{DS} .
3. For periods greater than T_s and less than or equal to T_L , the design spectral response acceleration, S_a , shall be taken as given in Eq. (11.4-4):

$$S_a = \frac{S_{DI}}{T} \quad (11.4-4)$$

4. For periods greater than T_L , S_a shall be taken as given in Eq. (11.4-5):

$$S_a = \frac{S_{DI} T_L}{T^2} \quad (11.4-5)$$

Where

S_{DS} = the design spectral response acceleration parameter at short periods

S_{DI} = the design spectral response acceleration parameter at a 1-s period

T = the fundamental period of the structure

$T_0 = 0.2(S_{DI}/S_{DS})$

$T_s = S_{DI}/S_{DS}$, and

T_L = long-period transition period(s) shown in Figs. 22-14 through 22-17.

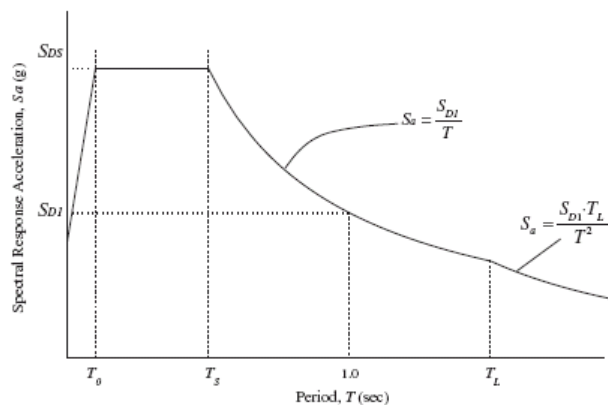

FIGURE 11.4-1 Two-Period Design Response Spectrum

11.4.6 Risk-Targeted Maximum Considered Earthquake (MCE_R) Response Spectrum

Where an MCE_R response spectrum is required, it shall be determined by multiplying the design response spectrum by 1.5.

11.4.7 Site-Specific Ground Motion Procedures

A site response analysis shall be performed in accordance with Section 21.1 for structures on Site Class F sites, unless exempted in accordance with Section 20.3.1. A ground motion hazard analysis shall be performed in accordance with Section 21.2 for seismically isolated structures and structures with damping systems on sites with S_I greater than or equal to 0.6.

It shall be permitted to perform a site response analysis in accordance with Section 21.1 and/or a ground motion hazard analysis in accordance with Section 21.2 to determine ground motions for any structure.

When the procedures of either Section 21.1 or 21.2 are used, the design response spectrum shall be determined in accordance with Section 21.3, the design acceleration parameters shall be determined in accordance with Section 21.4, and, if required, the MCE_G peak ground acceleration parameter PGA_M shall be determined in accordance with Section 21.5.

SECTION 11.5 IMPORTANCE FACTOR AND RISK CATEGORY

Replace Section 11.5 with the following:

11.5.1 Importance Factor

An Importance Factor, I_e , shall be assigned to each structure in accordance with Table 1.5-2.

11.5.2 Protected Access for Risk Category IV

Where operational access to a Risk Category IV structure is required through an adjacent structure, the adjacent structure shall conform to the requirements for Risk Category IV structures. Where operational access is less than 10 ft (3.048 m) from an interior lot line or another structure on the same lot, protection from potential falling debris from adjacent structures shall be provided by the owner of the Risk Category IV structure.

SECTION 11.6 SEISMIC DESIGN CATEGORY

Replace Section 11.6 with the following:

Structures shall be assigned a Seismic Design Category in accordance with this section.

Risk Category I, II, or III structures located where the mapped spectral response acceleration parameter at 1-s period, S_1 , is greater than or equal to 0.75 shall be assigned to Seismic Design Category E. Risk Category IV structures located where the mapped spectral response acceleration parameter at 1-s period, S_1 , is greater than or equal to 0.75 shall be assigned to Seismic Design Category F. All other structures shall be assigned to a Seismic Design Category based on their Risk Category and the design spectral response acceleration parameters, S_{DS} and S_{DI} , determined in accordance with Section 11.4.4. Each building and structure shall be assigned to the more severe Seismic Design Category in accordance with Table 11.6-1 or 11.6-2, irrespective of the fundamental period of vibration of the structure, T . The provisions in Chapter 19 shall not be used to modify the spectral response acceleration parameters for determining Seismic Design Category.

TABLE 11.6-1 Seismic Design Category Based on Short-Period Response Acceleration Parameter

Value of S_{DS}	Risk Category	
	I or II or III	IV
$S_{DS} < 0.167$	A	A
$0.167 \leq S_{DS} < 0.33$	B	C
$0.33 \leq S_{DS} < 0.50$	C	D
$0.50 \leq S_{DS}$	D	D

TABLE 11.6-2 Seismic Design Category Based on 1-s Period Response Acceleration Parameter

Value of S_{D1}	Risk Category	
	I or II or III	IV
$S_{D1} < 0.067$	A	A
$0.067 \leq S_{D1} < 0.133$	B	C
$0.133 \leq S_{D1} < 0.20$	C	D
$0.20 \leq S_{D1}$	D	D

Where S_I is less than 0.75, the Seismic Design Category is permitted to be determined from Table 11.6-1 alone where all of the following apply:

1. In each of the two orthogonal directions, the approximate fundamental period of the structure, T_a , determined in accordance with Section 12.8.2.1 is less than $0.8T_s$, where T_s is determined in accordance with Section 11.4.5.
2. In each of two orthogonal directions, the fundamental period of the structure used to calculate the story drift is less than T_s .
3. Eq. (12.8-2) is used to determine the seismic response coefficient C_s .
4. The diaphragms are rigid in accordance with Section 12.3; or, for diaphragms that are not rigid, the horizontal distance between vertical elements of the seismic force-resisting system does not exceed 40 ft (12.192 m).

Where the alternate simplified design procedure of Section 12.14 is used, the Seismic Design Category is permitted to be determined from Table 11.6-1 alone, using the value of S_{DS} determined in Section 12.14.8.1, except that where S_I is greater than or equal to 0.75, the Seismic Design Category shall be E.

User note: The Seismic Design Category is provided via the USGS Seismic Design Geodatabase, defined in Section 11.2.

SECTION 11.7 DESIGN REQUIREMENTS FOR SEISMIC DESIGN CATEGORY A

Replace Section 11.7 with the following:

Buildings and other structures assigned to Seismic Design Category A need only comply with the requirements of Section 1.4. Nonstructural components in SDC A are exempt from seismic design requirements. In addition, tanks assigned to Risk Category IV shall satisfy the freeboard requirement in Section 15.6.5.1.

SECTION 11.8 GEOLOGIC HAZARDS AND GEOTECHNICAL INVESTIGATION

Replace Section 11.8 with the following:

11.8.1 Site Limitation for Seismic Design Categories E and F

A structure assigned to Seismic Design Category E or F shall not be located where a known potential exists for an active fault to cause rupture of the ground surface at the structure.

11.8.2 Geotechnical Investigation Report Requirements for Seismic Design Categories C through F

A geotechnical investigation report shall be provided for a structure assigned to Seismic Design Category C, D, E, or F in accordance with this section. An investigation shall be conducted, and a report shall be submitted that includes an evaluation of the following potential geologic and seismic hazards:

- a. Slope instability,
- b. Liquefaction,
- c. Total and differential settlement, and
- d. Surface displacement caused by faulting or seismically induced lateral spreading or lateral flow.

The report shall contain recommendations for foundation designs or other measures to mitigate the effects of the previously mentioned hazards.

EXCEPTION: Where approved by the authority having jurisdiction, a site-specific geotechnical report is not required where prior evaluations of nearby sites with similar soil conditions provide direction relative to the proposed construction.

11.8.3 Additional Geotechnical Investigation Report Requirements for Seismic Design Categories D through F

The geotechnical investigation report for a structure assigned to Seismic Design Category D, E, or F shall include all of the following, as applicable:

1. The determination of dynamic seismic lateral earth pressures on basement and retaining walls caused by design earthquake ground motions.
2. The potential for liquefaction and soil strength loss evaluated for site peak ground acceleration, earthquake magnitude, and source characteristics consistent with the MCE_G peak ground acceleration. Peak ground acceleration shall be determined based on either (1) a site-specific study taking into account soil amplification effects as specified in Section 11.4.7 or (2) the value of the MCE_G peak ground acceleration parameter PGA_M of the USGS Seismic Design Geodatabase <https://doi.org/10.5066/F7NK3C76>, from which the value of the PGA_M parameter is provided by the USGS Seismic Design Web Service for the site class determined in accordance with Section 11.4.2.

3. Assessment of potential consequences of liquefaction and soil strength loss, including, but not limited to, estimation of total and differential settlement, lateral soil movement, lateral soil loads on foundations, reduction in foundation soil-bearing capacity and lateral soil reaction, soil downdrag and reduction in axial and lateral soil reaction for pile foundations, increases in soil lateral pressures on retaining walls, and flotation of buried structures.
4. Discussion of mitigation measures such as, but not limited to, selection of appropriate foundation type and depths, selection of appropriate structural systems to accommodate anticipated displacements and forces, ground stabilization, or any combination of these measures and how they shall be considered in the design of the structure.

SECTION 11.9 VERTICAL GROUND MOTIONS FOR SEISMIC DESIGN

Replace Section 11.9 with the following:

11.9.1 General

If the option to incorporate the effects of vertical seismic ground motions is exercised in lieu of the requirements of Section 12.4.2.2, the requirements of this section are permitted to be used in the determination of the vertical design earthquake ground motions. The requirements of Section 11.9.2 shall only apply to structures in Seismic Design Categories C, D, E, and F located in the conterminous United States at or west of -105 degrees longitude, Alaska, Hawaii, and other non-conterminous United States sites. For structures in Seismic Design Categories C, D, E, and F in the conterminous United States east of -105 degrees longitude, the value of S_{aMv} shall be taken as two-thirds of the value of S_{aM} . The requirements of Section 11.9.3 shall apply to all structures in Seismic Design Categories C, D, E, and F.

11.9.2 MCE_R Vertical Response Spectrum

Where a vertical response spectrum is required by this standard and site-specific procedures are not used, the MCE_R vertical response spectral acceleration, S_{aMv} , shall be developed as follows:

1. For vertical periods (T_v) less than or equal to 0.025 s, S_{aMv} shall be determined in accordance with Eq. (11.9-1) as follows:

$$S_{aMv} = 0.65C_v(S_{aM}/F_{md}) \quad (11.9-1)$$

2. For vertical periods greater than 0.025 s and less than or equal to 0.05 s, S_{aMv} shall be determined in accordance with Eq. (11.9-2) as follows:

$$S_{aMv} = 16C_v(S_{aM}/F_{md})(T_v - 0.025) + 0.65C_v(S_{aM}/F_{md}) \quad (11.9-2)$$

3. For vertical periods greater than 0.05 s and less than or equal to 0.1 s, S_{aMv} shall be determined in accordance with Eq. (11.9-3) as follows:

$$S_{aMv} = 1.05C_v(S_{aM}/F_{md}) \quad (11.9-3)$$

4. For vertical periods greater than 0.1 s and less than or equal to 2.0 s, S_{aMv} shall be determined as:

$$S_{aMv} = 1.05C_v(S_{aM}/F_{md}) \left(\frac{0.1}{T_v}\right)^{0.5} \quad (11.9-4)$$

The value of S_{aMv} shall not be less than $0.5(S_{aM}/F_{md})$.

5. For vertical periods greater than 2.0 s and less than 10 s, S_{aMv} shall be determined using Eq. (11.9-5) as follows:

$$S_{aMv} = 0.5(S_{aM}/F_{md}) \quad (11.9-5)$$

Where

C_v is defined in terms of S_{MS} in Table 11.9-1,

S_{aM} = the MCE_R spectral response acceleration parameter at the same period as S_{aMv} ,

F_{md} = factor to convert the median-component spectral ordinate to a maximum direction spectral ordinate, and

T_v = the fundamental vertical period of vibration.

TABLE 11.9-1 Values of Vertical Coefficient C_v

MCE _R Spectral Response Parameter at Short Periods ^a	Site Class A, B	Site Class BC	Site Class C	Site Class CD	Site Class D, DE, E, F
$S_{MS} \geq 2.0$	0.9	1.1	1.3	1.4	1.5
$S_{MS} = 1.0$	0.9	1.0	1.1	1.2	1.3
$S_{MS} = 0.6$	0.9	0.95	1.0	1.05	1.1
$S_{MS} = 0.3$	0.8	0.8	0.8	0.85	0.9
$S_{MS} \leq 0.2$	0.7	0.7	0.7	0.7	0.7

^aUse straight-line interpolation for intermediate values of S_{MS} .

Maximum-component factor F_{md} shall be taken as follows:

$$T_v \leq 0.2 \text{ sec: } F_{md} = 1.2 \quad (11.9-6)$$

$$0.2 < T_v \leq 1.0 \text{ sec: } F_{md} = 1.2 + 0.0625(T_v - 0.2) \quad (11.9-7)$$

$$1 < T_v \leq 10 \text{ sec: } F_{md} = 1.25 + 0.05(T_v - 1.0)/9 \quad (11.9-8)$$

In lieu of using the above procedure, a site-specific study is permitted to be performed to obtain S_{aMv} , but the value so determined shall not be less than 80% of the S_{aMv} value determined from Eqs. (11.9-1) through (11.9-5).

11.9.3 Design Vertical Response Spectrum

The design vertical response spectral acceleration, S_{av} , shall be taken as two-thirds of the value of S_{aMv} determined in Sections 11.9.1 or 11.9.2.

Page intentionally left blank.

CHAPTER 12, SEISMIC DESIGN REQUIREMENTS FOR BUILDING STRUCTURES

(Modifications)

SECTION 12.2.1 SEISMIC FORCE-RESISTING SYSTEM SELECTION AND LIMITATIONS

Revise Section 12.2.1 as follows:

Except as noted in Sections 12.2.1.1, the basic lateral and vertical seismic force-resisting system shall conform to one of the types indicated in Table 12.2-1 or a combination of systems as permitted in Sections 12.2.2, 12.2.3, and 12.2.4. Each system is subdivided by the types of vertical elements used to resist lateral seismic forces. The structural systems used shall be in accordance with the structural system limitations and the limits on structural height, h_n , contained in Table 12.2-1. The appropriate response modification coefficient, R ; overstrength factor, Ω_0 ; and deflection amplification factor, C_d , indicated in Table 12.2-1 shall be used in determining the base shear, element design forces, and design story drift.

EXCEPTION: For structures with seismic-force resisting systems that otherwise conform with the system requirements in Table 12.2-1, limitations on structural height, h_n , are permitted to be exceeded for structures designed to meet the requirements of Chapter 16. This exception shall not apply to seismic force-resisting systems designated as NP for the Seismic Design Category in Table 12.2-1.

Each selected seismic force-resisting system shall be designed and detailed in accordance with the specific requirements for the system as set forth in the applicable reference document listed in Table 12.2-1 and the additional requirements set forth in Chapter 14.

Nothing contained in this section shall prohibit the use of alternative procedures for the design of individual structures that demonstrate acceptable performance in accordance with the requirements of Section 1.3.1.3 of this standard."

Table 12.2-1 Design Coefficients and Factors for Seismic Force-Resisting Systems

Add new line items featuring Reinforced Concrete Ductile Coupled Walls, Steel and Concrete Coupled Composite Plate Shear Walls, and Cross-Laminated Timber Shear Walls as follows:

Seismic Force-Resisting System	ASCE 7 Section Where Detailing Requirements Are Specified	R	Ω_0	C_d	Structural System Limitations Including Structural Height, h_n (ft) Limits ^d				
					Seismic Design Category				
					B	C	D	E	F
A. BEARING WALL SYSTEMS									
Reinforced concrete ductile coupled walls	14.2	8	2½	8	NL	NL	160	160	100
Cross laminated timber shear walls	14.5	3	3	3	65	65	65	65	65
Cross laminated timber shear walls with shear resistance provided by high aspect ratio panels only	14.5	4	3	4	65	65	65	65	65
B. BUILDING FRAME SYSTEMS									
Reinforced concrete ductile coupled walls	14.2	8	2½	8	NL	NL	160	160	100
Steel and concrete coupled composite plate shear walls	14.3	8	2½	5½	NL	NL	160	160	100

D. DUAL SYSTEMS WITH SPECIAL MOMENT FRAMES...									
Reinforced concrete ductile coupled walls	14.2	8	2½	8	NL	NL	NL	NL	NL
Steel and concrete coupled composite plate shear walls	14.3	8	2½	5½	NL	NL	NL	NL	NL
....									

12.2.1.1 Alternative Seismic Force-Resisting Systems

Use of alternative seismic force-resisting systems not contained in Table 12.2-1 shall be permitted contingent on submittal to and approval by the Authority Having Jurisdiction and independent structural design review of an accompanying set of design criteria and substantiating analytical and test data. The design criteria shall specify any limitations on system use, including Seismic Design Category and height; required procedures for designing the system's components and connections; required detailing; and the values of the response modification coefficient, R ; overstrength factor, Ω_0 ; and deflection amplification factor, C_d . The submitted data shall establish the system's nonlinear dynamic characteristics and demonstrate that the design criteria result in a probability of collapse conditioned on the occurrence of MCE_R shaking not greater than 10% for Risk Category II structures. The conditional probability of collapse shall be determined based on a nonlinear analytical evaluation of the system and shall account for sources of uncertainty in quality of the design criteria, modeling fidelity, laboratory test data, and ground motions. Structural design review shall conform to the criteria of Section 16.5.

This Section shall be permitted for the design of single buildings on a given site with a seismic force-resisting system not conforming to one of the systems included in Table 12.2-1.

12.2.1.2 Elements of Seismic Force-Resisting Systems

Elements of seismic force-resisting systems, including members and their connections, shall conform to the detailing requirements specified in Table 12.2-1 for the selected structural system.

EXCEPTION: Substitute elements that do not conform to the requirements specified in Table 12.2-1 shall be permitted contingent on submittal to and approval by the authority having jurisdiction of all of the following:

- a. In-depth description of the methodology used to evaluate equivalency of the substitute element for the seismic force-resisting system of interest, or reference to published documentation describing the methodology in depth.
- b. Justification of the applicability of the equivalency methodology, including but not limited to consideration of the similarity of the forces transferred across the connection between the substitute and conforming elements and the balance of the seismic force-resisting system, and the similarity between the substitute and conforming element on the distribution of forces and displacements in the balance of the structure.
- c. A design procedure for the substitute elements, including procedures to determine design strength stiffness, detailing, connections, and limitations to applicability and use.
- d. Requirements for the manufacturing, installation, and maintenance of the substitute elements.
- e. Experimental evidence demonstrating that the hysteretic characteristics of the conforming and substitute elements are similar through deformation levels anticipated in response to MCE_R shaking. The evaluation of experimental evidence shall include assessment of the ratio of the measured maximum strength to design strength; the ratio of the measured initial

stiffness to design stiffness; the ultimate deformation capacity; and the cyclic strength and stiffness deterioration characteristics of the conforming and substitute elements.

- f. Evidence of independent structural design review, in accordance with Section 16.5 or review by a third party acceptable to the authority having jurisdiction, of conformance to the requirements of this section.

SECTION 12.2.3.2 TWO-STAGE ANALYSIS PROCEDURE

Replace Section 12.2.3.2 with the following:

Two-stage equivalent lateral force procedures for vertical combinations of systems or for one-story structures with flexible diaphragms and rigid vertical elements are permitted in accordance with the section.

12.2.3.2.1 Vertical Combinations of Systems

A two-stage equivalent lateral force procedure is permitted to be used for structures that have a flexible upper portion and a rigid lower portion, provided that the design of the structure conforms with all of the following:

- a. The stiffness of the lower portion shall be not less than 10 times the stiffness of the upper portion.
- b. The period of the entire structure shall not be greater than 1.1 times the period of the upper structure considered as a separate structure supported at the transition from the upper to the lower portion.
- c. The upper portion shall be designed as a separate structure using the appropriate values of R and ρ .
- d. The lower portion shall be designed as a separate structure using the appropriate values of R and ρ . The reactions from the upper portion amplified by the ratio of the R/ρ of the upper portion over the R/ρ of the lower portion. This ratio shall not be less than 1.0.
- e. The upper portion is analyzed with the equivalent lateral force or modal response spectrum procedure, and lower portion is analyzed with the equivalent lateral force procedure.

12.2.3.2.2 One-Story Structures with Flexible Diaphragms and Rigid Vertical Elements

A two-stage equivalent lateral force procedure shall be permitted to be used for determination of seismic design forces in vertical elements of one-story structures having flexible diaphragms supported by rigid vertical elements, provided that the structure conforms to all of the following:

- a. The structure shall comply with the requirements of Section 12.10.4.
- b. The seismic design forces to the vertical elements in each horizontal direction shall be taken as the sum of forces contributed by the effective seismic weight tributary to the diaphragm and forces contributed by the effective seismic weight tributary to the in-plane vertical elements as follows:
 - i. Forces contributed by the effective seismic weight tributary to the diaphragm shall be the reactions from diaphragm forces determined in accordance with Section 12.10.4.2.1, amplified by the ratio of R_{diaph} divided by R/ρ of the vertical seismic force-resisting system. This ratio shall not be taken as less than 1.0.
 - ii. Forces contributed by the effective seismic weight tributary to the in-plane rigid vertical elements shall be determined in accordance with Section 12.8 using the period calculated in accordance with Section 12.8.

SECTION 12.2.5 SYSTEM-SPECIFIC REQUIREMENTS

Revise Section 12.2.5.4 as follows:

12.2.5.4 Increased Structural Height Limit for Steel Eccentrically Braced Frames, Steel Special Concentrically Braced Frames, Steel Buckling-Restrained Braced Frames, Steel Special Plate Shear Walls, Steel and Concrete Coupled Composite Plate Shear Walls, Reinforced Concrete Ductile Coupled Walls, and Special Reinforced Concrete Shear Walls

The limits on structural height, h_n , in Table 12.2-1 are permitted to be increased from 160 ft (50 m) to 240 ft (75 m) for structures assigned to Seismic Design Categories D or E and from 100 ft (30 m) to 160 ft (50 m) for structures assigned to Seismic Design Category F, provided that the seismic force-resisting systems are limited to steel eccentrically braced frames, steel special concentrically braced frames, steel buckling-restrained braced frames, steel special plate shear walls, reinforced concrete ductile coupled walls, or special reinforced concrete cast-in-place shear walls and both of the following requirements are met:

1. The structure shall not have an extreme torsional irregularity as defined in Table 12.3-1 (horizontal structural irregularity Type 1b).
2. The steel eccentrically braced frames, steel special concentrically braced frames, steel buckling-restrained braced frames, steel special plate shear walls, steel and concrete coupled composite plate shear walls, reinforced concrete ductile coupled walls, or special reinforced cast-in-place concrete shear walls in any one plane shall resist no more than 60% of the total seismic forces in each direction, neglecting accidental torsional effects.

ACI 318, Building Code Requirements and Commentary, American Concrete Institute, 2019.

Cited in: Section 11.2.

SECTION 12.3.2 IRREGULAR AND REGULAR CLASSIFICATION

Revise Section 12.3.2.2 as follows:

12.3.2.2 Vertical Irregularity

EXCEPTIONS:

Vertical structural irregularities of Types 1a, 1b, and 2 in Table 12.3-2 do not apply where no story drift ratio is greater than 130% of the story drift ratio of the next story above. For this exception torsional effects need not be considered in the calculation of story drifts and the story drift ratio relationship of the top two stories of the structure is not required to be evaluated.

Table 12.3-1 Horizontal Structural Irregularities

Revise Tables 12.3-1 and 12.3-2 as follows:

Type	Description	Reference Section	Seismic Design Category Application
1a.	Torsional Irregularity: Torsional irregularity is defined to exist where more than 75% of the story lateral strength is provided at or on one side of the center of mass or where the maximum story drift, computed including accidental torsion with $A_x=1.0$, at one end of the structure transverse to an axis is more than 1.2 times the average of the story drifts at the two ends of the structure.	12.3.3.4	D, E, and F

Type	Description	Reference Section	Seismic Design Category Application
	Torsional irregularity requirements in the reference sections apply only to structures in which the diaphragms are rigid or semirigid.		
12.5.3.1	C, D, E and F		
12.7.3	B, C, D, E, and F		
12.8.4.3	C, D, E, and F		
12.12.1	C, D, E, and F		
16.3.4	B, C, D, E, and F		
1b.	Extreme Torsional Irregularity: Extreme torsional irregularity is defined to exist where the maximum story drift, computed including accidental torsion with $A_x = 1.0$, at one end of the structure transverse to an axis is more than 1.4 times the average of the story drifts at the two ends of the structure. Extreme torsional irregularity requirements in the reference sections apply only to structures in which the diaphragms are rigid or semirigid.		
12.3.3.4	D, E and F		
12.3.4.2	D, E and F		
12.5.3.1	C, D, E and F		
12.7.3	B, C, D, E and F		
12.8.4.3	C, D, E and F		
12.12.1	C, D, E and F		
16.3.4	B, C, D, E and F		
2.	Reentrant Corner Irregularity: Reentrant corner irregularity is defined to exist where both plan projections of the structure beyond a reentrant corner are greater than 15% of the plan dimension of the structure in the given direction.	12.3.3.4	D, E, and F
3.	Diaphragm Discontinuity Irregularity: Diaphragm discontinuity irregularity is defined to exist where there is a diaphragm with an abrupt discontinuity or variation in stiffness, including one that has a cutout or open area greater than 50% of the gross enclosed diaphragm area, or a change in effective diaphragm stiffness of more than 50% from one story to the next.	12.3.3.4	D, E, and F
4.	Out-of-Plane Offset Irregularity: Out-of-plane offset irregularity is defined to exist where there is a discontinuity in a lateral force-resistance path, such as an out-of-plane offset of at least one of the vertical elements.	12.3.3.3	B, C, D, E, and F
12.3.3.4	D, E, and F		
12.7.3	B, C, D, E, and F		
16.3.4	B, C, D, E, and F		
5.	Nonparallel System Irregularity: Nonparallel system irregularity is defined to exist where vertical lateral force-resisting	12.5.3	C, D, E, and F

Type	Description	Reference Section	Seismic Design Category Application
	elements are not parallel to the major orthogonal axes of the seismic force-resisting system.		
12.7.3	B, C, D, E, and F		
16.3.4	B, C, D, E, and F		

Table 12.3-2 Vertical Structural Irregularities

Type	Description	Reference Section	Seismic Design Category Application
1a.	Stiffness–Soft Story Irregularity: Stiffness–soft story irregularity is defined to exist where there is a story in which the lateral stiffness is less than 70% of that in the story above or less than 80% of the average stiffness of the three stories above.	Table 12.6-1	D, E, and F
1b.	Stiffness–Extreme Soft Story Irregularity: Stiffness–extreme soft story irregularity is defined to exist where there is a story in which the lateral stiffness is less than 60% of that in the story above or less than 70% of the average stiffness of the three stories above.	12.3.3.1	E and F
2.	Vertical Geometric Irregularity: Vertical geometric irregularity is defined to exist where the horizontal dimension of the seismic force-resisting system in any story is more than 130% of that in an adjacent story.	Table 12.6-1	D, E, and F
3.	In-Plane Discontinuity in Vertical Lateral Force-Resisting Element Irregularity: In-plane discontinuity in vertical lateral force-resisting element irregularity is defined to exist where there is an in-plane offset of a vertical seismic force-resisting element resulting in overturning demands on supporting structural elements.	12.3.3.3	B, C, D, E, and F
12.3.3.4	D, E, and F		
	Table 12.6-1	D, E, and F	
4a.	Discontinuity in Lateral Strength–Weak Story Irregularity: Discontinuity in lateral strength–weak story irregularity is defined to exist where the story lateral strength is less than 80% of that in the story above. The story lateral strength is the total lateral strength of all seismic-resisting elements sharing the story shear for the direction under consideration.	12.3.3.1	E and F
	Table 12.6-1	D, E, and F	
4b.	Discontinuity in Lateral Strength–Extreme Weak Story Irregularity: Discontinuity in lateral strength–extreme weak story irregularity is defined to exist where the story lateral strength is less than 65% of that in the story above. The story strength is the	12.3.3.1	D, E, and F

Type	Description	Reference Section	Seismic Design Category Application
	total strength of all seismic-resisting elements sharing the story shear for the direction under consideration.		
12.3.3.2	B and C		
	Table 12.6-1	D, E, and F	

SECTION 12.3.3 LIMITATIONS AND ADDITIONAL REQUIREMENTS FOR SYSTEMS WITH STRUCTURAL IRREGULARITIES

Replace Section 12.3.3 with the following:

12.3.3.1 Prohibited Vertical Irregularities for Seismic Design Categories D through F

Structures assigned to Seismic Design Category E or F that have vertical irregularities Type 1b, 4a, or 4b, of Table 12.3-2 shall not be permitted. Structures assigned to Seismic Design Category D that have vertical irregularity Type 4b of Table 12.3-2 shall not be permitted.

12.3.3.2 Extreme Weak Stories

Structures with a vertical irregularity Type 4b, as defined in Table 12.3-2, shall not be more than two stories or 30 ft (9 m) in structural height, h_n .

EXCEPTION: The limit does not apply where the “weak” story is capable of resisting a total seismic force equal to Ω_0 times the design force prescribed in Section 12.8.

12.3.3.3 Elements Supporting Discontinuous Walls or Frames

Structural elements supporting discontinuous walls or frames of structures that have horizontal irregularity Type 4 of Table 12.3-1 or vertical irregularity Type 3 of Table 12.3-2 shall be designed to resist the seismic load effects, including overstrength of Section 12.4.3. The connections of such discontinuous walls or frames to the supporting members shall be adequate to transmit the forces for which the discontinuous walls or frames were required to be designed.

12.3.3.4 Increase in Forces Caused by Irregularities for Seismic Design Categories D through F

For structures assigned to Seismic Design Category D, E, or F and having a horizontal structural irregularity of Type 1a, 1b, 2, 3, or 4 in Table 12.3-1 or a vertical structural irregularity of Type 3 in Table 12.3-2, the design forces determined from Section 12.10.1.1 shall be increased 25% for the following elements of the seismic force-resisting system:

1. Connections of diaphragms to vertical elements and to collectors and
2. Collectors and their connections, including connections to vertical elements, of the seismic force-resisting system.

EXCEPTION: Forces calculated using the seismic load effects, including overstrength of Section 12.4.3, need not be increased.

SECTION 12.3.4 REDUNDANCY

Revise Sections 12.3.4.1 and 12.3.4.2 as follows:

12.3.4.1 Conditions Where Value of ρ is 1.0.

The value of ρ is permitted to be equal to 1.0 for the following:

1. Structures assigned to Seismic Design Category B or C;
2. Drift calculation and P-delta effects;
3. Design of nonstructural components;
4. Design of nonbuilding structures that are not similar to buildings;
5. Design of collector elements, splices, and their connections for which the seismic load effects, including overstrength of Section 12.4.3 are used;
6. Design of members or connections where the seismic load effects, including overstrength of Section 12.4.3 are required for design;
7. Diaphragm loads determined using Eq. (12.10-1) including the limits imposed by Eqs. (12.10-2) and (12.10-3);
8. Diaphragm seismic design forces determined in accordance with Section 12.10.4;
9. Structures with damping systems designed in accordance with Chapter 18; and
10. Design of structural walls for out-of-plane forces, including their anchorage.

12.3.4.2 Redundancy Factor, ρ , for Seismic Design Categories D through F

For structures assigned to Seismic Design Categories D, E or F, and having an extreme torsional irregularity in both orthogonal directions as defined in Table 12.3-1, Type 1b, ρ shall equal 1.3 in both orthogonal directions. For other structures assigned to Seismic Design Categories D, E or F ρ shall equal 1.3 unless one of the following two conditions is met, whereby ρ is permitted to be taken as 1.0. For the purposes of the conditions below, the number of bays for a shear wall shall be calculated as the length of shear wall divided by the story height or two times the length of shear wall divided by the story height, h_{sx} , for light-frame construction.

- a. Each story resisting more than 35% of the base shear in the direction of interest shall comply with Table 12.3-3, and each story resisting more than 35% of the base shear in the direction of interest shall contain at least two bays of seismic force-resisting framing on each side of the center of mass.
- b. Structures are regular in plan at all levels provided that the seismic force-resisting systems consist of at least two bays of seismic force-resisting perimeter framing on each side of the structure in each orthogonal direction at each story resisting more than 35% of the base shear.

SECTION 12.5.3 SEISMIC DESIGN CATEGORY C

Revise Section 12.5.3.1 as follows:

12.5.3.1 Structures with Horizontal Structural Irregularities

Structures that have horizontal structural irregularity of Type 1a, 1b or 5 in Table 12.3-1 shall use one of the following procedures:

- a. **Orthogonal Combination Procedure.** The structure shall be analyzed using the equivalent lateral force analysis procedure of Section 12.8, the modal response spectrum

analysis (MRSA) procedure of Section 12.9.1, or the linear response history procedure of Section 12.9.2, as permitted under Section 12.6, with the loading applied independently in any two orthogonal directions. The requirement of Section 12.5.1 is deemed satisfied if members and their foundations are designed for 100% of the forces for one direction plus 30% of the forces for the perpendicular direction. The combination requiring the maximum component strength shall be used.

- b. **Simultaneous Application of Orthogonal Ground Motion.** The structure shall be analyzed using the linear response history procedure of Section 12.9.2 or the nonlinear response history procedure of Chapter 16, as permitted by Section 12.6, with orthogonal pairs of ground motion acceleration histories applied simultaneously.

SECTION 12.6 ANALYSIS PROCEDURE SELECTION

Replace Section 12.6 with the following (delete Table 12.6-1 Permitted Analytical Procedures):

The structural analysis required by Chapter 12 shall be completed in accordance with the requirements of (a) Equivalent Lateral Force Procedure of Section 12.8, (b) Modal Response Spectrum Analysis of Section 12.9.1, (c) Linear Response History Analysis of Section 12.9.2, or (d) with an analysis approved by the authority having jurisdiction. Nonlinear Response History Procedure requirements are given in Chapter 16.

SECTION 12.7.3 STRUCTURAL MODELING

Revise Section 12.7.3 as follows:

- b. For steel moment frame systems, the contribution of panel zone deformations to displacement and drift shall be included.

SECTION 12.8.6 DISPLACEMENT AND DRIFT DETERMINATION

Replace section 12.8.6 with the following:

Displacements and drifts shall be determined as required by this section.

12.8.6.1 Minimum Base Shear for Computing Displacement and Drift

The elastic analysis of the seismic force-resisting system for computing displacement and drift shall be made using the prescribed seismic design forces of Section 12.8 and the strength load combinations of Section 2.3.6.

12.8.6.2 Period for Computing Displacement and Drift

For determining displacements and drifts it is permitted to determine the elastic displacements (δ_e) using seismic design forces based on the computed fundamental period of the structure without the upper limit ($C_u T_a$) specified in Section 12.8.2.

12.8.6.3 Design Earthquake and Maximum Considered Earthquake Displacement

The Design Earthquake Displacement (δ_{DE}) shall be determined at the location of an element or component using equation 12.8-15 or as permitted in Chapter 16, Chapter 17, or Chapter 18.

$$\delta_{DE} = \frac{C_d \delta_e}{I_e} + \delta_{di} \quad (12.8-15)$$

Where

C_d = the Deflection Amplification Factor in Table 12.2-1.

I_e = Importance Factor determined in accordance with Section 11.5.1; and

δ_e = elastic displacement computed under design earthquake forces.

δ_{di} = displacement due to diaphragm deformation due to the Design Earthquake.

The Design Earthquake Displacement shall include the contribution of diaphragm rotation and deformation to the displacement at the location of an element or component, including the effects of accidental torsion and torsional amplification.

The Maximum Considered Earthquake Displacement (δ_{MCE}) shall be determined at the location under consideration using equation 12.8-16 or as permitted in Chapter 16, Chapter 17, or Chapter 18.

$$\delta_{MCE} = 1.5 \left[\frac{R \delta_e}{I_e} + \delta_{di} \right] \quad (12.8-16)$$

Where R is the Response Modification Coefficient in Table 12.2-1.

12.8.6.4 Design Story Drift Determination

The Design Story Drift (Δ) shall be computed as the difference of the Design Earthquake Displacements (δ_{DE}), as determined in accordance with Section 12.8.6.3, at the centers of mass at the top and bottom of the story under consideration. Where centers of mass do not align vertically, it is permitted to compute the deflection at the bottom of the story based on the vertical projection of the center of mass at the top of the story.

Diaphragm rotation shall be considered in determining the Design Story Drift for structures assigned to Seismic Design Category C, D, E, or F that have horizontal irregularity Type 1a or 1b of Table 12.3-1. For such structures the Design Story Drift, Δ , shall be computed as the largest difference of the Design Earthquake Displacements of vertically aligned points at the top and bottom of the story under consideration along any of the edges of the structure. Diaphragm deformation may be neglected in determining the Design Story Drift.

SECTION 12.9.1.4.2 SCALING OF DISPLACEMENTS AND DRIFTS

Revise Section 12.9.1.4.2 as follows

Where the combined response for the modal base shear (V_t) is less than $C_s W$, and where C_s is determined in accordance with Eq. (12.8-6), displacements and drifts shall be multiplied by $C_s W / V_t$.

SECTION 12.10 DIAPHRAGMS, CHORDS AND COLLECTORS

Revise Section 12.10 as follows:

Diaphragms, chords and collectors shall be designed in accordance with Sections 12.10.1 and 12.10.2.

EXCEPTIONS:

1. Precast concrete diaphragms, including chords and collectors, in structures assigned to Seismic Design Category C, D, E or F, shall be designed in accordance with Section 12.10.3.

2. Precast concrete diaphragms in Seismic Design Category B, cast-in-place concrete diaphragms, wood-sheathed diaphragms supported by wood diaphragm framing, and bare steel deck diaphragms are permitted to be designed in accordance with Section 12.10.3.
3. Diaphragms, chords and collectors in one-story structures that conform to the limitations of Section 12.10.4.1 are permitted to be designed in accordance with Section 12.10.4.

Table 12.10-1 Diaphragm Design Force Reduction Factor, R_s

Revise Table 12.10-1 as follows:

Diaphragm System		Shear-Controlled	Flexure-Controlled
Cast-in-place concrete designed in accordance with Section 14.2 and ACI 318	—	1.5	2
Precast concrete designed in accordance with Section 14.2.4 and ACI 318	EDO ^a	0.7	0.7
	BDO ^b	1.0	1.0
	RDO ^c	1.4	1.4
Wood sheathed designed in accordance with Section 14.5 and 14.5 and AWC SDPWS-15	—	3.0	NA
Bare steel deck diaphragm designed in accordance with Section 14.1.5	With special seismic detailing	2.5	NA
	Other	1.0	NA

^aEDO is precast concrete diaphragm elastic design option.^bBDO is precast concrete diaphragm basic design option.^cRDO is precast concrete diaphragm reduced design option.

12.10.4 Alternative Diaphragm Design Provisions for One-Story Structures with Flexible Diaphragms and Rigid Vertical Elements

Add new Section 12.10.4 as follows:

Where permitted by Section 12.10 and subject to the limitations of Sec. 12.10.4.1, diaphragm design forces, including design forces for chords, collectors, and their in-plane connections to vertical elements, shall be determined in accordance with Sections 12.10.4.2.

12.10.4.1 Limitations

Diaphragms in one-story structures are permitted to be designed in accordance with Section 12.10.4 provided all of the following limitations are satisfied;

1. All portions of the diaphragm shall be designed using the provisions of this section in both orthogonal directions.

2. The diaphragm shall consist of either a) a wood structural panel diaphragm designed in accordance with AWC SDPWS and fastened to wood framing members or wood nailers with sheathing nailing in accordance with the AWC SDPWS Section 4.2 nominal shear capacity tables, or b) a bare (untopped) steel deck diaphragm meeting the requirements of AISI S400 and AISI S310.
3. Toppings of concrete or similar materials that affect diaphragm strength or stiffness shall not be placed over the wood structural panel or bare steel deck diaphragm.
4. The diaphragm shall not contain horizontal structural irregularities, as specified in Table 12.3-1, except that Horizontal Structural Irregularity Type 2 is permitted.
5. The diaphragm shall be rectangular in shape or shall be divisible into rectangular segments for purpose of seismic design, with vertical elements of the seismic force-resisting system or collectors provided at each end of each rectangular segment span.
6. The vertical elements of the seismic force-resisting system shall be limited to one or more of the following: concrete shear walls, precast concrete shear walls, masonry shear walls, steel concentrically braced frames, steel and concrete composite braced frames, or steel and concrete composite shear walls.
7. The vertical elements of the seismic force-resisting system shall be designed in accordance with Section 12.8, except that they shall be permitted to be designed using the two-stage analysis procedure of Section 12.2.3.2.2, where applicable.

12.10.4.2 Design

Diaphragms, including chords, collectors, and their connections to vertical elements, shall be designed in two orthogonal directions to resist the in-plane design seismic forces determined in accordance with this section. Multi-span diaphragms and diaphragms that are not rectangular in shape shall be divided into rectangular segments for purposes of design in accordance with this section, with lateral support provided at each end of each diaphragm segment span by a vertical element or collector element.

12.10.4.2.1 Seismic Design Forces

The diaphragm seismic design force, F_{px} , shall be determined in accordance with Eq. 12.10-15.

$$F_{px} = C_{s\text{-diaph}} * W_{px} \quad (12.10-15)$$

where

w_{px} = the effective seismic weight tributary to the diaphragm,

$$C_{s\text{-diaph}} = \frac{S_{DS}}{R_{diaph}/I_e} \quad (12.10-16a)$$

and need not be greater than:

$$C_{s\text{-diaph}} = \frac{S_{D1}}{T_{diaph} * (R_{diaph}/I_e)} \quad (12.10-16b)$$

where

S_{DS} = the design spectral response parameter in the short period range as determined from Section 11.4.5 or 11.4.8,

R_{diaph} = 4.5 for wood structural panel diaphragms,

= 4.5 for bare steel deck diaphragms that meet the special seismic detailing requirements of AISI S400, and

= 1.5 for all other bare steel deck diaphragms

I_e = the Importance Factor determined in accordance with Section 11.5.1.

T_{diaph} = 0.002 L_{diaph} , for wood structural panel diaphragms, and

= 0.001 L_{diaph} for profiled steel deck panel diaphragms

determined for each rectangular segment of the diaphragm in each orthogonal direction [seconds].

12.10.4.2.2 Diaphragm Shears

Diaphragm design shears shall be computed for each diaphragm segment in accordance with Section 12.10.4.2.1.

Where the diaphragm segment span, L_{diaph} , is less than 100 feet, the diaphragm design shear, from loading perpendicular to the span, shall be the diaphragm shear calculated using the F_{px} forces of Section 12.10.4.2.1 multiplied by 1.5.

Where the diaphragm segment span L_{diaph} , is greater than or equal to 100 feet, the diaphragm design shear shall be amplified to 1.5 times the shear calculated using the F_{px} forces of Section 12.10.4.2.1, over an amplified shear boundary zone having a minimum width of 10% of the diaphragm segment span L_{diaph} . The amplified shear boundary zone shall be provided at each supporting end of the diaphragm segment span under consideration.

12.10.4.2.3 Diaphragm Chords

Diaphragm chords shall be provided at each edge of each diaphragm segment to resist tension and compression forces resulting from diaphragm moments. Diaphragm chord forces shall be computed using the F_{px} forces of Section 12.10.4.2.1.

12.10.4.2.4 Collector Elements and Their Connections

Collector elements shall be provided that are capable of transferring the seismic forces originating in other portions of the structure to the vertical elements of the seismic force-resisting system. Collector element forces shall be computed using the F_{px} forces of Section 12.10.4.2.1. Collectors and their connections to vertical elements of the seismic force-resisting system in structures assigned to Seismic Design Categories C through F shall be designed to resist the forces calculated using the seismic load effects including overstrength factor of Section 12.4.3, with diaphragm overstrength factor, $\Omega_{0-diaph}$, taken equal to 2, however $\Omega_{0-diaph}$ need not exceed R_{diaph} . This need not be combined with the shear amplification of 1.5 specified in Section 12.10.4.2.2.

12.10.4.2.5 Diaphragm Deflection

Where required by this standard, the deflection amplification factor, $C_{d-diaph}$, for diaphragm deflection shall be taken as one of the following:

$C_{d-diaph}$ = 3.0 for wood structural panel diaphragms,

= 3.0 for bare steel deck diaphragms that meet the special seismic detailing requirements of AISI S400, and

= 1.5 for all other bare steel deck diaphragms

Diaphragm deflections shall be calculated using Section 12.10.4.2.1 seismic design forces.

12.10.4.2.6 Modifications to Diaphragm Seismic Design

For structures in which the diaphragm design forces are determined in accordance with Section 12.10.4, the following modifications apply.

1. Footnote b to Table 12.2-1 shall not apply
2. Section 12.3.3.4 shall not apply

SECTION 12.12 DRIFT AND DEFORMATION

Replace Section 12.12 with the following:

12.12.1 Story Drift Limit

The Design Story Drift (Δ) as determined in Sections 12.8.6, 12.9.1, or 12.9.2 shall not exceed the allowable story drift (Δ_a) as obtained from Table 12.12-1 for any story.

TABLE 12.12-1 ALLOWABLE STORY DRIFT, $\Delta_a^{a,b}$

Structure	Risk Category		
	I or II	III	IV
Structures, other than masonry shear wall structures, 4 stories or less above the base as defined in Section 11.2, with interior walls, partitions, ceilings and exterior wall systems that have been designed to accommodate the Design Earthquake Displacements.	$0.025h_{sx}^c$	$0.020h_{sx}$	$0.015h_{sx}$
Masonry cantilever shear wall structures ^d	$0.010h_{sx}$	$0.010h_{sx}$	$0.010h_{sx}$
Other masonry shear wall structures	$0.007h_{sx}$	$0.007h_{sx}$	$0.007h_{sx}$
All other structures	$0.020h_{sx}$	$0.015h_{sx}$	$0.010h_{sx}$

^a h_{sx} is the story height below Level x .

^b For seismic force-resisting systems comprised solely of moment frames in Seismic Design Categories D, E, and F, the allowable story drift shall comply with the requirements of Section 12.12.1.1.

^c There shall be no drift limit for single-story structures in which the interior walls, partitions, ceilings, exterior wall systems, and nonstructural components with I_p greater than 1.0 have been designed to accommodate the Design Earthquake Displacement. The structure separation requirement of Section 12.12.3 is not waived.

^d Structures in which the basic structural system consists of masonry shear walls designed as vertical elements cantilevered from their base or foundation support which are so constructed that moment transfer between shear walls (coupling) is negligible.

12.12.2 Structural Separation

All portions of the structure shall be designed and constructed to act as an integral unit in resisting seismic forces unless separated structurally by a distance sufficient to avoid damaging contact as set forth in this section.

Separations shall allow for the Design Earthquake Displacements (δ_{DE}) as determined in accordance with Section 12.8.6.

Adjacent structures on the same property shall be separated by at least δ_{SS} , determined as follows:

$$\delta_{SS} = \sqrt{(\delta_{DE1})^2 + (\delta_{DE2})^2} \quad (12.12-2)$$

where δ_{DE1} and δ_{DE2} are the Design Earthquake Displacements of the adjacent structures at their adjacent edges.

Where a structure adjoins a property line not common to a public way, the structure shall be set back from the property line by at least the displacement δ_{DE} of that structure.

EXCEPTION: Smaller separations or property line setbacks are permitted where justified by rational analysis based on inelastic response to design ground motions.

12.12.3 Members Spanning between Structures

Gravity connections or supports for members spanning between structures or seismically separate portions of structures shall be designed for the maximum anticipated relative displacements. These displacements shall be calculated using the Maximum Considered Earthquake Displacement (δ_{MCE}), as determined in accordance with Section 12.8.6 and assuming that the two structures are moving in opposite directions and using the absolute sum of the displacements.

12.12.4 Deformation Compatibility for Seismic Design Categories D through F

For structures assigned to Seismic Design Category D, E, or F, every structural component not included in the seismic force-resisting system in the direction under consideration shall be designed to be adequate for the gravity load effects and the seismic forces resulting from two-thirds of the Maximum Considered Earthquake Displacements (δ_{MCE}) and the associated drifts.

EXCEPTION: Reinforced concrete frame members not designed as part of the seismic force-resisting system shall comply with Section 18.14 of ACI 318.

Where determining the moments and shears induced in components that are not included in the seismic force-resisting system in the direction under consideration, the stiffening effects of adjoining rigid structural and nonstructural elements shall be considered, and a rational value of member and restraint stiffness shall be used.

SECTION 12.14 SIMPLIFIED ALTERNATIVE STRUCTURAL DESIGN CRITERIA FOR SIMPLE BEARING WALL OR BUILDING FRAME SYSTEMS

Table 12.14-1 Design Coefficients and Factors for Seismic Force-Resisting Systems for Simplified Design Procedures

Add line items to Table 12.14-1 on Bearing Wall Systems featuring CLT shear walls as follows:

Seismic Force-Resisting System	ASCE 7 Section Where Detailing Requirements Are Specified	R ^a	Limitations ^b		
			Seismic Design Category		
			B	C	D, E
A. BEARING WALL SYSTEMS					
Cross laminated timber shear walls	14.5	3	P	P	P
Cross laminated timber shear walls with shear resistance provided by high aspect ratio panels only	14.5	4	P	P	P

Page intentionally left blank.

CHAPTER 13, SEISMIC DESIGN REQUIREMENTS FOR NONSTRUCTURAL COMPONENTS

(Modifications)

SECTION 13.1 SCOPE

Revise Section 13.1.1, 13.1.2, 13.1.3, and 13.1.6 as follows:

13.1.1 Scope

This chapter establishes minimum design criteria for nonstructural components and for their supports and attachments.

Nonstructural components shall meet the requirements of this chapter, including components that are in or supported by a structure, are outside of a structure, or are permanently attached to the mechanical or electrical systems of a structure. Where the weight of a nonstructural component is greater than or equal to 20% of the combined effective seismic weight, W , of the nonstructural component and supporting structure as defined in Section 12.7.2, the component shall be designed in accordance with Section 13.2.8.

13.1.2 Seismic Design Category

For the purposes of this chapter, nonstructural components shall be assigned to the same Seismic Design Category as the structure that they occupy or are supported by, or to the same Seismic Design Category as the structure to which they are permanently attached by mechanical or electrical systems.

13.1.3 Component Importance Factor

All components shall be assigned a component Importance Factor as indicated in this section. The component Importance Factor, I_p , shall be taken as 1.5 if any of the following conditions apply:

1. The component is required to function for life-safety purposes after an earthquake, including fire protection sprinkler systems and egress stairways.
2. The component conveys, supports, or otherwise contains toxic, highly toxic, or explosive substances where the quantity of the material exceeds a threshold quantity established by the Authority Having Jurisdiction and is sufficient to pose a threat to the public if released.
3. The component is in or supported by a Risk Category IV structure or permanently attached by mechanical or electrical systems to a Risk Category IV structure, and the component is needed for continued operation of the facility or its failure could impair the continued operation of the facility.
4. The component conveys, supports, or otherwise contains hazardous substances and is attached to a structure or portion thereof classified by the Authority Having Jurisdiction as a hazardous occupancy.

All other components shall be assigned a component Importance Factor, I_p , equal to 1.0.

13.1.6 Application of Nonstructural Component Requirements to Nonbuilding Structures

Nonbuilding structures (including storage racks and tanks) that are supported by other structures shall be designed in accordance with Chapter 15. Where Section 15.3 requires that seismic forces be determined in accordance with Chapter 13 and values for C_{AR} and R_{po} are not provided in Table 13.5-1 or 13.6-1, the

term $\left[\frac{C_{AR}}{R_{po}}\right]$ in Eq. (13.3-1) shall be taken as equal to $2.5/R$, where the value of R for the nonbuilding structure is obtained from Tables 15.4-1 or 15.4-2.

SECTION 13.2.2 SPECIAL CERTIFICATION REQUIREMENTS FOR DESIGNATED SEISMIC SYSTEMS

Revise Section 13.2.2 Item 2 as follows:

2. Components with hazardous substances and assigned a component Importance Factor, I_p , of 1.5 in accordance with Section 13.1.3 shall be certified by the manufacturer as maintaining containment following the design earthquake ground motion by (1) analysis, (2) approved shake table testing in accordance with Section 13.2.5, or (3) experience data in accordance with Section 13.2.6. Evidence demonstrating compliance with this requirement shall be submitted for approval to the Authority Having Jurisdiction after review and acceptance by a registered design professional.

Certification of components through analysis shall be limited to nonactive components and shall be based on seismic demand considering $\left[\frac{C_{AR}}{R_{po}}\right]/I_p$ equal to 1.0.

SECTION 13.2.8 SUPPORTED NONSTRUCTURAL COMPONENTS WITH GREATER THAN OR EQUAL TO 20% COMBINED WEIGHT

Add section 13.2.8 with the following:

Supported Nonstructural Components with Greater Than or Equal to 20% Combined Weight. For the condition where the weight of the nonstructural component is equal to or greater than 20% of the combined effective seismic weight, W , of the nonstructural component and supporting structure, an analysis combining the structural characteristics of both the nonstructural component and the supporting structures shall be performed to determine the seismic design forces. The nonstructural component and the supporting structure shall be designed for forces and displacements determined in accordance with Chapter 12 or Section 15.5, as appropriate, with the R value of the combined system taken as the lesser of the value $\left[\frac{C_{AR}}{R_{po}}\right]$ of the nonstructural component or the R value of the supporting structure. The nonstructural component and attachments shall be designed for the forces and displacements resulting from the combined analysis. Design criteria for the nonstructural component shall otherwise be in accordance with this chapter.

SECTION 13.3.1 SEISMIC DESIGN FORCES

Replace Section 13.3.1 with the following:

The horizontal seismic design force (F_p) shall be applied at the component's center of gravity and distributed relative to the component's mass distribution and be applied independently in at least two orthogonal horizontal directions in combination with service or operating loads associated with the component, as appropriate. The redundancy factor, ρ , is permitted to be taken as equal to 1.

The horizontal seismic design force shall be determined in accordance with Eq. (13.3-1):

$$F_p = 0.4S_{DS}I_pW_p \left[\frac{H_f}{R_\mu}\right] \left[\frac{C_{AR}}{R_{po}}\right] \quad (13.3-1)$$

F_p is not required to be taken as greater than

$$F_p = 1.6S_{DS}I_pW_p \quad (13.3-2)$$

and F_p shall not be taken as less than

$$F_p = 0.3S_{DS}I_pW_p \quad (13.3-3)$$

where

F_p = seismic design force;

S_{DS} = spectral acceleration, short period as determined in accordance with Section 11.4.5;

I_p = component Importance Factor as determined in accordance with Section 13.1.3;

W_p = component operating weight;

H_f = factor for force amplification as a function of height in the structure as determined in Section 13.3.1.1;

R_μ = structure ductility reduction factor as determined in Section 13.3.1.2;

C_{AR} = component resonance ductility factor that converts the peak floor or ground acceleration into the peak component acceleration as determined in Section 13.3.1.3;

R_{po} = component strength factor as determined in Section 13.3.1.4.

13.3.1.1 Amplification with Height, H_f

For nonstructural components supported at or below grade, $H_f = 1.0$. For components supported above grade by a building or nonbuilding structure, the factor for force amplification with height, H_f , is determined by Eq. (13.3-4) or Eq. (13.3-5). Where the approximate fundamental period of the supporting building or nonbuilding structure is unknown, H_f is permitted to be determined by Eq. (13.3-5).

$$H_f = 1 + a_1 \left(\frac{z}{h}\right) + a_2 \left(\frac{z}{h}\right)^{10} \quad (13.3-4)$$

$$H_f = 1 + 2.5 \left(\frac{z}{h}\right) \quad (13.3-5)$$

where

$$a_1 = \frac{1}{T_a} \leq 2.5$$

$$a_2 = [1 - (0.4/T_a)^2] > 0$$

z = height in structure of point of attachment of component with respect to the base. For items at or below the base, z shall be taken as 0. The value of $\frac{z}{h}$ need not exceed 1.0;

h = average roof height of structure with respect to the base; and

T_a = the approximate fundamental period of the supporting building or nonbuilding structure. For structures with combinations of seismic force-resisting systems, the lowest value of T_a shall be used.

For the purposes of computing H_f , T_a is determined using Eq. (12.8-7) for buildings. Where the seismic force-resisting system is unknown, T_a is permitted to be determined by Eq. (12.8-7) using the approximate period parameters for “All other structures.”

For nonbuilding structures, T_a is permitted to be taken as:

- a. The period of the nonbuilding structure, T , determined using the structural properties and deformation characteristics of the resisting elements in a properly substantiated analysis as indicated in Section 12.8.2, or
- b. The period of the nonbuilding structure, T , determined using Eq. (15.4-6), or
- c. The period T_a determined by Eq. (12.8-7), using the approximate period parameters for “All other structures.”

13.3.1.2 Structure Ductility Reduction Factor, R_μ

For components supported by a building or nonbuilding structure, the reduction factor for ductility of the supporting structure, R_μ , is determined by Eq. (13.3-6):

$$R_\mu = (1.1R/\Omega_0)^{1/2} \geq 1.3 \quad (13.3-6)$$

where

R = the response modification factor for the building or nonbuilding structure supporting the component, from Table 12.2-1, Table 15.4-1, or Table 15.4-2; and

Ω_0 = the overstrength factor for the building or nonbuilding structure supporting the component, from Table 12.2-1, Table 15.4-1, or Table 15.4-2.

For components supported at or below grade, the value of R_μ shall be taken as 1.0. When the seismic force-resisting system of the building or nonbuilding structure is not specified, the value of R_μ shall be taken as 1.3. When the seismic force-resisting system of the building or nonbuilding structure is not listed in Table 12.2-1, Table 15.4-1, or Table 15.4-2, the value of R_μ shall be taken as 1.3, unless seismic design parameters for the seismic force-resisting system have been approved by the Authority Having Jurisdiction.

If the building or nonbuilding structure supporting the component contains combinations of seismic force-resisting systems in different directions or vertical combinations of seismic force-resisting systems, the structure ductility reduction factor shall be based on the seismic force-resisting system that produces the lowest value of R_μ . Where a nonbuilding structure type listed in Table 15.4-1 has multiple entries based on permissible height increases, the value of R_μ is permitted to be determined using values of R and Ω_0 for “With permitted height increase” entry.

13.3.1.3 Component Resonance Ductility Factor, C_{AR}

Components shall be assigned a component resonance ductility factor, C_{AR} , based on whether the component is supported at or below grade, or is supported above grade by a building or nonbuilding structure. Components that are in or supported by a building or nonbuilding structure and are at or below grade plane are considered supported at or below grade. All other components in or supported by a building or nonbuilding structure are considered supported above grade.

Architectural components shall be assigned a component resonance ductility factor in Table 13.5-1.

Mechanical and electrical equipment shall be assigned a component resonance ductility factor in Table 13.6-1. The component resonance ductility factor for mechanical and electrical equipment mounted on the equipment support structures or platforms shall not be less than the component resonance ductility factor used for the equipment support structure or platform itself.

The component resonance ductility factor for equipment platforms or support structures shall be determined in accordance with Section 13.6.4.6. The weight of supported mechanical and electrical components shall be included when calculating the component operating weight, W_p , of equipment platform or support structure.

Distribution systems shall be assigned component resonance ductility factors in Table 13.6-1, to be used for the design of the distribution system itself (e.g. the piping, ducts, and raceways). The component resonance ductility factor for distribution system supports shall be determined in accordance with Section 13.6.4.7.

13.3.1.4 Component Strength, R_{po}

The component strength factor, R_{po} , for nonstructural components is given in Tables 13.5-1 or 13.6-1.

13.3.1.5 Nonlinear Response History Analysis

Nonlinear response history analyses procedures of Chapters 16, 17 and 18 may be used to determine the lateral force for nonstructural components in accordance with Eq. (13.3-7):

$$F_p = I_p W_p a_i \left[\frac{C_{AR}}{R_{po}} \right] \quad (13.3-7)$$

Where a_i is the maximum acceleration at level i obtained from the nonlinear response history analysis at the Design Earthquake ground motion. When a_i is determined using nonlinear response history analysis, a suite of not less than 7 ground motions shall be used. If the supporting structure is designed using nonlinear response history analysis, the entire suite of ground motions used to design the structure shall be used to determine a_i . The value of the parameter a_i shall be taken as the mean of the maximum values of acceleration at the center of mass of the support level, obtained from each analysis. The upper and lower limits of F_p determined by Eqs. (13.3-2) and (13.3-3) shall apply.

13.3.1.6 Vertical Force

The component shall be designed for a concurrent vertical force $\pm 0.2 S_{DS} W_p$.

EXCEPTION: The concurrent vertical seismic force need not be considered for lay-in access floor panels and lay-in ceiling panels.

13.3.1.7 Nonseismic Loads

Where nonseismic loads on nonstructural components exceed F_p , such loads shall govern the strength design, but the detailing requirements and limitations prescribed in this chapter shall apply.

SECTION 13.3.2 SEISMIC RELATIVE DISPLACEMENTS

Revise Section 13.3.2 as follows:

13.3.2.1 Displacements within Structures

For two connection points on the same structure A or the same structural system, one at a height h_x and the other at a height h_y , D_p shall be determined as

$$D_p = \delta_{xA} - \delta_{yA} \quad (13.3-7)$$

Alternatively, D_p is permitted to be determined using linear dynamic procedures described in Section 12.9. For structures in which the Design Earthquake Displacement does not exceed the allowable story drift as defined in Table 12.12-1, D_p is not required to be taken as greater than

$$D_p = \frac{(h_x - h_y)\Delta_{aA}}{h_{sx}} \quad (13.3-8)$$

13.3.2.2 Displacements between Structures

For two connection points on separate structures A and B or separate structural systems, one at a height h_x and the other at a height h_y , D_p shall be determined as

$$D_p = |\delta_{xA}| + |\delta_{yB}| \quad (13.3-9)$$

For structures in which the Design Earthquake Displacement does not exceed the allowable story drift as defined in Table 12.12-1, D_p is not required to be taken as greater than

$$D_p = \frac{h_x \Delta_{aA}}{h_{sx}} + \frac{h_y \Delta_{aB}}{h_{sx}} \quad (13.3-10)$$

where

D_p = relative seismic displacement that the component must be designed to accommodate;

δ_{xA} = deflection at building level x of structure A at the Design Earthquake Displacement, determined in accordance with Eq. (12.8-15);

δ_{yA} = deflection at building level y of structure A at the Design Earthquake Displacement, determined in accordance with Eq. (12.8-15);

δ_{yB} = deflection at building level y of structure B at the Design Earthquake Displacement, determined in accordance with Eq. (12.8-15);

SECTION 13.4 NONSTRUCTURAL COMPONENT ANCHORAGE AND ATTACHMENT

Revise Section 13.4 as follows:

13.4.1 Design Force in the Attachment

The force in the attachment shall be determined based on the prescribed forces and displacements for the component as determined in Sections 13.3.1 and 13.3.2. When required to apply the load combinations in Section 12.4.3, Ω_0 shall be taken as the anchorage overstrength factor Ω_{op} given in Tables 13.5-1 and 13.6-1.

13.4.2 Anchors in Concrete or Masonry

13.4.2.1 Anchors in Concrete

Anchors in concrete shall be designed in accordance with Chapter 17 of ACI 318.

13.4.2.2 Anchors in Masonry

Anchors in masonry shall be designed in accordance with TMS 402. Anchors shall be designed to be governed by the tensile or shear strength of a ductile steel element.

EXCEPTION: Anchors shall be permitted to be designed so that either

1. the support or component that the anchor is connecting to the structure undergoes ductile yielding at a load level corresponding to anchor forces not greater than the design strength of the anchors, or
2. the anchors shall be designed to resist the load combinations in accordance with Section 12.4.3 including Ω_{op} given in Tables 13.5-1 and 13.6-1.

SECTION 13.5.3 EXTERIOR NONSTRUCTURAL WALL ELEMENTS AND CONNECTIONS

Revise Section 13.5.3 with the following:

Exterior nonstructural wall panels or elements that are attached to or enclose the structure shall be designed to accommodate the seismic relative displacements defined in Section 13.3.2 and movements caused by temperature changes. Such elements shall be supported by means of positive and direct structural supports or by mechanical connections and fasteners in accordance with the following requirements:

1. Connections and panel joints shall allow for the story drift caused by relative seismic displacements (D_{pl}) determined in Section 13.3.2, or 0.5 in. (13 mm), whichever is greater.

...

4. All fasteners in the connecting system such as bolts, inserts, welds, and dowels, and the body of the connectors shall be designed for the force (F_p) determined by Section 13.3.1 using the applicable design coefficients and taken from Table 13.5-1, applied at the center of mass of the panel. The connecting system shall include both the connections between the wall panels or elements and the structure and the interconnections between wall panels or elements.

...

SECTION 13.5.10 EGRESS STAIRS AND RAMPS

Revise Section 13.5.10 as follows:

Egress stairs and ramps not part of the seismic force-resisting system of the structure to which they are attached shall be detailed to accommodate the seismic relative displacements, D_{pl} , defined in Section 13.3.2 including diaphragm deformation. The net relative displacement shall be assumed to occur in any horizontal direction. Such elements shall be supported by means of positive and direct structural supports or by mechanical connections and fasteners in accordance with the following requirements:

- a. Sliding connections with slotted or oversize holes, sliding bearing supports with keeper assemblies or end stops, and connections that permit movement by deformation of metal attachments, shall accommodate a displacement D_{pl} , but not less than 0.5 in. (13 mm), without loss of vertical support or inducement of displacement-related compression forces in the stair.
- b. Sliding bearing supports without keeper assemblies or end stops shall be designed to accommodate a displacement $1.5D_{pl}$, but not less than 1.0 in. (25 mm) without loss of vertical support. Breakaway restraints are permitted if their failure does not lead to loss of vertical support.
- c. Metal supports shall be designed with rotation capacity to accommodate seismic relative displacements as defined in item b. The strength of such metal supports shall not be limited by bolt shear, weld fracture, or other brittle modes.
- d. All fasteners and attachments such as bolts, inserts, welds, dowels, and anchors shall be designed for the seismic design forces determined in accordance with Section 13.3.1 using the applicable design coefficients as given in Table 13.5-1.

EXCEPTION: If sliding or ductile connections are not provided to accommodate seismic relative displacements, the stiffness and strength of the stair or ramp structure shall be included in the building structural model of Section 12.7.3, and the stair shall be designed with Ω_0 corresponding to the seismic force-resisting system but not less than $2\frac{1}{2}$.

SECTION 13.5.11 PENTHOUSES AND ROOFTOP STRUCTURES

Add Section 13.5.11 with the following:

Penthouses and rooftop structures shall be designed in accordance with this section. The horizontal seismic design force (F_p) shall be determined in accordance with Section 13.3.1, using the design coefficients listed in Table 13.5-1.

EXCEPTION: Penthouses and rooftop structures framed by an extension of the building frame and designed in accordance with the requirements of Chapter 12.

13.5.11.1 Seismic Force-Resisting Systems for Penthouses and Rooftop Structures

The seismic force-resisting system for penthouses and rooftop structures shall conform to one of the types indicated in Table 12.2-1 or Table 15.4-1. The structural systems used shall be in accordance with the structural system limitations noted in the tables and shall be designed and detailed in accordance with the specific requirements for the system as set forth in the applicable reference documents listed in Table 12.2-1 or Table 15.4-1 and the additional requirements set forth in Chapter 14. Height limits for penthouses and rooftop structures shall be measured from the top of the roof deck.

EXCEPTION: Penthouses and rooftop structures designed using the coefficients for “Other Systems” in Table 13.5-1 and which also conform to the requirements of relevant material standards need

not conform to one of the types indicated in Table 12.2-1 or Table 15.4-1. The height limit for penthouses and rooftop structures designed using the coefficients for “Other Systems” shall be 28 feet (8534 mm).

Table 13.5-1 Coefficients for Architectural Components

Revise Table 13.5-1 as follows:

ARCHITECTURAL COMPONENTS	C_{AR}		R_{po}	Ω_{op}^a
	Supported at or below grade	Supported above grade by a structure		
Interior nonstructural walls and partition ^{sb}				
Light frame \leq 9ft (2.74m) in height	1	1	1.5	1.5
Light frame $>$ 9ft (2.74m) in height	1.4	1.4	1.5	2
Reinforced masonry	1	1	1.5	1.5
All other walls and partitions	2	2.8	1.5	1.5
Cantilever elements (unbraced or braced to structural frame below its center of mass)				
Parapets and cantilever interior nonstructural walls	1.8	2.2	1.5	1.75
Chimneys where laterally braced or supported by the structural frame	1.8	2.2	1.5	1.75
Cantilever elements (braced to structural frame above its center of mass)				
Parapets	1	1	1.5	1.5
Chimneys	1	1	1.5	1.5
Exterior nonstructural walls	1	1	1.5	1.5
Exterior nonstructural wall elements and connections				
Wall element	1	1	1.5	1.5
Body of wall panel connections	1	1	1.5	1.5
Fasteners of the connecting system	2.2	2.8	1.5	1
Veneer				
Limited deformability elements and attachments	1	1	1.5	1.5
Low-deformability elements and attachments	1	1	1.5	1.5
Penthouses (except where framed by an extension of the building frame)				
Seismic Force-Resisting Systems with $R \geq 6$	N/A	1.4	2	2
Seismic Force-Resisting Systems with $6 > R \geq 4$	N/A	2.2	2	1.75
Seismic Force-Resisting Systems with $R < 4$	N/A	2.8	2	1.5
Other systems	N/A	2.8	1.5	1.5
Ceilings				
All	1	1	1.5	1.5
Cabinets				
Permanent floor-supported storage cabinets more than 6ft (1,829 mm) tall, including contents	1	1	1.5	1.5
Permanent floor-supported library shelving, bookstacks, and bookshelves more than 6ft (1,829 mm) tall, including contents	1	1	1.5	1.5
Laboratory equipment	1	1	1.5	1.5
Access floors				
Special access floors (designed in accordance with Section 13.2.7.2)	1	1	1.5	1.5
All other	2.2	2.8	1.5	1.5
Appendages and ornamentations	1.8	2.2	1.5	1.75
Signs and billboards	1.8	2.2	1.5	1.75
Other rigid components	1	1	1.5	1.5
Other flexible components				
High-deformability elements and attachments	1.4	1.4	1.5	2
Limited-deformability elements and attachments	1.8	2.2	1.5	1.75
Low-deformability materials and attachments	2.2	2.8	1.5	1.5
Egress stairways not part of the building seismic force-resisting system	1	1	1.5	1.5
Egress stair and rap fasteners and attachments	1.8	2.2	1.5	1.75

^a Overstrength factor where required for nonductile anchorage to concrete and masonry. See Section 12.4.3 for seismic load effects including overstrength.

^b Where flexible diaphragms provide lateral support for concrete or masonry walls and partitions, the design forces for anchorage to the diaphragm shall be as specified in Section 12.11.2.

SECTION 13.6.2.1 HVACR EQUIPMENT

Revise Section 13.6.2.1 as follows:

13.6.2.1 HVACR Equipment

HVACR equipment that has been qualified in accordance with the requirements of Chapters 1 through 10 of ANSI/AHRI Standard 1270 (I-P) or ANSI/AHRI Standard 1271 (SI) shall be deemed to meet the seismic qualification requirements of Section 13.2.2, provided all of the following requirements are met:

- Active and/or energized components shall be seismically certified exclusively through shake table testing or experience data; and
- Seismic demand considered in the certification of non-active components through analysis shall be based on $\left[\frac{C_{AR}}{R_{po}} \right] / I_p$ equal to 1.0; and
- Capacity of non-active components used in seismic certification by analysis shall be based on the provisions of ASCE 7; and
- Rugged components shall conform to the definition in Chapter 11.

SECTION 13.6.4 COMPONENT SUPPORTS

Revise Section 13.6.4 as follows:

Mechanical and electrical component supports (including those with $I_p=1.0$) and the means by which they are attached to the component shall be designed for the forces and displacements determined in Sections 13.3.1 and 13.3.2. Such supports include structural members, braces, frames, skirts, legs, saddles, pedestals, cables, guys, stays, snubbers, tethers, and elements forged or cast as a part of the mechanical or electrical component.

13.6.4.1 Design Basis

If standard supports, for example, ASME B31, NFPA 13, or MSS SP-58, or proprietary supports are used, they shall be designed by either load rating (i.e., testing) or for the calculated seismic forces. In addition, the stiffness of the support, where appropriate, shall be designed such that the seismic load path for the component performs its intended function.

13.6.4.6 Equipment Platforms and Support Structures

Equipment platforms and support structures shall be designed for a lateral force based on their assigned component resonance ductility factor. The seismic force-resisting system for equipment support structures and platforms shall conform to one of the types indicated in Table 12.2-1 or Table 15.4-1. The seismic force-resisting system used shall be in accordance with the structural system limitations noted in the tables. The selected seismic force-resisting system shall be designed and detailed in accordance with the specific requirements for the system as set forth in the applicable reference documents listed in Table 12.2-1 or Table 15.4-1 and the additional requirements set forth in Chapter 14.

EXCEPTION: Equipment support structures and equipment supports platforms designed using the coefficients for “Other Systems” in Table 13.6-1 under “Equipment Supports” and which also conform to the requirements of relevant material standards need not conform to one of the types indicated in Table 12.2-1 or Table 15.4-1.

Equipment support structures or platforms that are supported by a building or nonbuilding structure are permitted to be designed using $C_{AR}=1$, $R_{po}=1.5$, and $\Omega_{op}=1.5$ if the ratio of $T_p/T_a < 0.2$, or if $T_p \leq 0.06$ seconds. The value of T_p for the equipment support structure or platform shall include consideration of the mass and stiffness of the components being supported.

13.6.4.7 Distribution System Supports.

Distribution system supports are assigned a component resonance ductility factor from Table 13.6-1, based on the type of support system.

Vertical and lateral supports for distribution systems, including trapeze assemblies, shall be designed for seismic forces and seismic relative displacements as required in Section 13.3, except as noted in Sections 13.6.5, 13.6.6, and 13.6.7. Distribution systems shall be braced to resist vertical, transverse, and longitudinal seismic loads. Seismic loads for distribution systems supports and trapeze assemblies shall be based on the weight of the distribution system tributary to the supports, including fittings and in-line components.

EXCEPTION: In-line components with independent support for vertical, transverse, and longitudinal seismic loads need not be included in the tributary weight to the distribution system supports.

Table 13.6-1 Seismic Coefficients for Mechanical and Electrical Components

Revise Table 13.6-1 as follows:

	C_{AR}		R_{po}	Ω_{op}^a
	Supported at or below grade	Supported above grade by a structure		
MECHANICAL AND ELECTRICAL COMPONENTS				
Air-side HVAC, fans, air handlers, air conditioning units, cabinet heaters, air distributions boxes, and other mechanical components constructed of sheet metal framing	1.4	1.4	2	2
Wet-side HVAC, boilers, furnaces, atmospheric tanks and bins, chillers, water heaters, heat exchangers, evaporators, air separators, manufacturing or process equipment, and other mechanical components constructed of high-deformability materials	1	1	1.5	1.5
Air coolers (fin fans), air-cooled heat exchangers, condensing units, dry coolers, remote radiators and other mechanical components elevated on integral structural steel of sheet metal supports	1.8	2.2	1.5	1.75
Engines, turbines, pumps, compressors, and pressure vessels not supported on skirts and not within the scope of Chapter 15	1	1	1.5	1.5
Skirt-supported pressure vessels not within the scope of Chapter 15	1.8	2.2	1.5	1.75
Elevator components	1.8	2.2	1.5	1.75
Escalator components	1	1	1.5	1.5
Generators, batteries, inverters, motors, transformers, and other electrical components constructed of high-deformability materials	1	1	1.5	1.5
Motor control centers, panel boards, switch gear, instrumentation cabinets, and other components, constructed of sheet metal framing	1.4	1.4	2	2
Communication equipment, computers instrumentation, and controls	1	1	1.5	1.5
Roof-mounted stacks, cooling and electrical towers laterally braced below their center of mass	1.8	2.2	1.5	1.75
Roof-mounted stacks, cooling and electrical towers laterally braced above their center of mass	1	1	1.5	1.5
Lighting fixtures	1	1	1.5	1.5
Other mechanical or electrical components	1	1	1.5	1.5
Manufacturing or process conveyors (nonpersonnel)	1.8	2.2	1.5	1.75
VIBRATION-ISOLATED COMPONENTS AND SYSTEMS^b				
Components and system isolated using neoprene elements and neoprene isolated floors with built-in or separate elastomeric snubbing devices or resilient perimeter stops	1.8	2.2	1.3	1.75
Spring-isolated components and systems and vibration-isolated floors closely restrained using built-in or separate elastomeric snubbing devices or resilient perimeter stops	1.8	2.2	1.3	1.75
Internally isolated components and systems	1.8	2.2	1.3	1.75
Suspended vibration-isolated equipment including in-line duct devices and suspended internally isolated components	1.8	2.2	1.3	1.75
EQUIPMENT SUPPORT STRUCTURES AND PLATFORMS				
Support structures and platforms where $T_p/T_d < 0.2$ or if $T_p \leq 0.06$ seconds per Section 13.6.4.6	N/A	1	1.5	1.5
Seismic Force-Resisting Systems with $R > 3$	1.4	1.4	1.5	2
Seismic Force-Resisting Systems with $R \leq 3$	1.8	2.2	1.5	1.75
Other systems	2.2	2.8	1.5	1.5
DISTRIBUTION SYSTEM SUPPORTS				
Tension-only and cable bracing	1	1	1.5	1.5
Cold-formed steel rigid bracing	1	1	1.5	1.5
Hot-rolled steel bracing	1	1	1.5	1.5
Other rigid bracing	1	1	1.5	1.5
Lateral resistance provided by rods in flexure	1.8	2.2	1.5	1.75
Vertical cantilever supports such as pipe tees and moment frames above and supported by a floor or roof	1.8	2.2	1.5	1.75

	C_{AR}		R_{po}	Ω_{op}^a
	Supported at or below grade	Supported above grade by a structure		
MECHANICAL AND ELECTRICAL COMPONENTS				
DISTRIBUTION SYSTEMS				
Piping in accordance with ASME B31 (2001, 2002, 2008, and 2010), including in-line components with joints made by welding or brazing	1	1	1.5	1.5
Piping in accordance with ASME B3, including in-line components, constructed of high- or limited-deformability materials, with joints made by threading, bonding, compression couplings, or grooved couplings	1	1	1.5	1.5
Piping and tubing not in accordance with ASME B31, including in-line components, constructed of high-deformability materials, with joints made by welding or brazing	1	1	1.5	1.5
Piping and tubing not in accordance with ASME B31, including in-line components, constructed of high- or limited-deformability materials, with joints made by threading, bonding, compression couplings, or grooved couplings	1.8	2.2	2	1.75
Piping and tubing constructed of low-deformability materials, such as cast iron, glass, and nonductile plastics	1.8	2.2	1.5	1.75
Duct systems, including in-line components, constructed of high-deformability materials, with joints made by welding or brazing	1	1	1.5	1.5
Duct systems, including in-line components, constructed of high- or limited-deformability materials with joints made by means other than welding or brazing	1	1	1.5	1.5
Duct systems, including in-line components, constructed of low-deformability materials, such as cast iron, glass, and nonductile plastics	1.8	2.2	1.5	1.75
Electrical conduit, cable trays, and raceways	1	1	1.5	1.5
Bus ducts	1	1	1.5	1.5
Plumbing	1	1	1.5	1.5
Pneumatic tube transport systems	1	1	1.5	1.5

^a Components mounted on vibration isolators shall have a bumper restraint or snubber in each horizontal direction. The design force shall be taken as $2F_p$ if the nominal clearance (air gap) between the equipment support frame and restraint is greater than 0.25 in. (6 mm). If the nominal clearance specified on the construction documents is not greater than 0.25 in. (6 mm), the design force is permitted to be taken as F_p .

^b Overstrength factor as required for anchorage to concrete and masonry. See Section 12.4.3 for seismic load effects including overstrength.

Page intentionally left blank.

CHAPTER 14, MATERIAL SPECIFIC SEISMIC DESIGN AND DETAILING REQUIREMENTS

(Modifications)

SECTION 14.1.5 COLD-FIRMED STEEL DECK DIAPHRAGMS

Replace Section 14.1.5 with the following:

Cold-formed steel deck diaphragms shall be designed in accordance with the requirements of AISI S100, SDI-RD, SDI-NC, SDI-C or ASCE 8, as applicable. Nominal strengths shall be determined in accordance with AISI S310. The required strength of diaphragms, including bracing members that form part of the diaphragm, shall be determined in accordance with Section 12.10. Where required by this standard, special seismic detailing requirements shall be in accordance with AISI S400 Section F3. Special inspections and qualification of welding special inspectors for cold-formed steel floor and roof deck shall be in accordance with the quality assurance inspection requirements of SDI-QA/QC.

14.1.5.1 Modifications to AISI S400

The text of AISI S400 shall be modified as indicated in sections 14.1.5.1.1.5. (See IT9-3)

14.1.5.1.1 AISI S400, Section A2.1

Add the following terms as follows:

A2.1 Terms

[Note, terms directly from AISI S310 brought to AISI S400]

SideLap. Joint at which adjacent *panels* contact each other along a longitudinal edge.

SideLap Connection. Also called a stitch *connection*. A *connection* with a fastener or weld located at a *side-lap* while not penetrating a support.

Structural Connection. Also called a support *connection*. A *connection* with a fastener or weld attaching one or more sheets to supporting members.

Support Connection. See *structural connection*.

[Note, terms from AISI S310 modified for AISI S400]

Profiled Steel Panel. Product formed from steel coils into fluted profiles with top and bottom flanges connected by web members having a singular or a repeating pattern.

Diaphragm Configuration. A specific arrangement of panel geometry, thickness, mechanical properties, span(s), and attachments that is unique to an assembly.

[Note, new terms for AISI S400]

Bare steel deck. *Steel deck* without concrete or other material covering.

Controlling Limit State. *Limit state* for a component that has the minimum design strength across all *limit states* relevant to the component strength.

Post-peak deflection. Range of deflection in a *component* beyond the peak strength in the *component* response.

Steel deck. *Profiled steel panels* installed on support framing in a roof or floor assembly including steel roof deck, non-composite steel floor deck, and composite steel floor deck.

14.1.5.1.2 AISI S400, Section A5

Add the following reference documents:

A5 Reference Documents

AISI S310-16, *North American Standard for the Design of Profiled Steel Diaphragm Panels*

AISI S905-17, *Test Standard for Determining the Strength and Deformation Characteristics of Cold-Formed Steel Connections*

AISI S907-17, *Test Standard for Determining the Strength and Stiffness of Cold-Formed Steel Diaphragms by the Cantilever Test Method*

14.1.5.1.3 AISI S400, Section F1.2

Modify AISI S400 Section F1.2 as follows:

F1.2 Design Basis

Diaphragms work to collect and distribute inertial forces to the *seismic force-resisting system*. They are not intended to work as a prescribed *energy-dissipating mechanism*, except those designed in accordance with Section F3.5.

14.1.5.1.4 AISI S400, Section F1.4.1.2

Add a new AISI S400 Section F1.4.1.2 as follows:

F1.4.1.2 Diaphragms Sheathed with Profiled Steel Panels

Exception, where the *diaphragm* is composed of inter-connected *bare steel deck*, the shear strength shall be determined by Section F3.

14.1.5.1.5 AISI S400, Section F3:

Add a new AISI S400 Section F3 as follows:

F3 Bare Steel Deck Diaphragms**F3.1 Scope**

Where the *diaphragm* is composed of inter-connected *bare steel deck* the *diaphragm* shall be designed in accordance with this section.

F3.2 Additional Design Requirements**F3.2.1 Special Seismic Detailing Requirements**

Where the *diaphragm* is required by the *applicable building code* to meet special seismic detailing the design shall comply with the provisions of Section F3.5.

F3.3 Required Strength [Effects of Factored Loads]

The *required strength* [*effects of factored loads*] of *diaphragms* and *diaphragm chords* and *collectors* shall be in accordance with the *applicable building code*.

F3.3.1 Diaphragm Stiffness

Stiffness for *bare steel deck diaphragms* shall be determined in accordance with AISI S310.

F3.4 Shear Strength

F3.4.1 Nominal Strength [Resistance]

The *nominal strength [resistance]* (V_n) of *bare steel deck diaphragms* shall be determined in accordance with AISI S310.

F3.4.2 Available Strength

The *available strength [factored resistance]* ($\phi_v V_n$ or V_n/Ω_v) shall be determined from the *nominal strength [resistance]* using the applicable *resistance* and *safety factors* given in AISI S310.

F3.5 Special Seismic Detailing Requirements

Where required to meet special seismic detailing requirements, *bare steel deck diaphragms* shall conform to the prescriptive requirements of Section F3.5.1 or the performance requirements of Section F3.5.2.

F3.5.1 Prescriptive Special Seismic Detailing

A *bare steel deck diaphragm* meeting the limits prescribed in AISI S310 shall be deemed to provide special seismic detailing provided all of the following criteria are satisfied.

1. The *steel deck* panel type shall be 36 in. (914 mm) wide 1.5 in. (38.1 mm) deep wide rib (WR) deck
2. The *steel deck base steel thickness* shall be greater than or equal to 0.0295 in. (0.749 mm) and less than or equal to 0.0598 in. (1.52 mm).
3. The *steel deck* material shall conform to AISI S100 Section A3.1.1
4. The *structural connection* between the *steel deck* and the supporting steel member (with minimum thickness of one-eighth in. (3.18mm)) shall be limited to mechanical *connectors* qualified in accordance with Section F3.5.1.1.
5. The *structural connection* perpendicular to the *steel deck* ribs shall be no less than a thirty-six fourths pattern (12 in. (305 mm) on center) and no more than a thirty-six ninths pattern (6 in. (152 mm) on center, with double fasteners in the last panel rib).
6. The *structural connection* parallel to the *steel deck* ribs shall be spaced no less than 3 in. (76.2 mm) and no more than 24 in. (610 mm) and shall not be greater than the *sidelap connection* spacing.
7. The *sidelap connection* between *steel deck* shall be limited to #10, #12, or #14 screws sized such that shear in the screws is not the *controlling limit state*, or *connectors* qualified in accordance with Section F3.5.1.2.
8. The *sidelap connection* shall be spaced no less than 6 in. (152 mm) and no more than 24 in. (610 mm),

F3.5.1.1 Structural Connection Qualification

A *structural connection* conforming to all of the following shall be deemed acceptable for the purposes of Section F3.5.1 condition (4):

1. The stiffness and strength of the *connection* are established in accordance with AISI S100. Neither shear of the *connector* nor shear pullout shall be permitted as the *controlling limit state*.
2. The ductility and deformation capacity shall be established through testing conducted in accordance with AISI S905. Tests shall be conducted with one of the approved details from

Section 7.1.1.2 of AISI S905. Reversed cyclic tests shall be performed for each *connection* in the *bare steel deck diaphragm configuration*. The minimum number of tests shall be in accordance with AISI S100 Section K2.1.1(a).

3. The mean ductility, μ , of the *connection* shall be greater than or equal to 20, and the mean residual force capacity, Q/Q_f , shall be at least 40% at a deformation defined as the maximum of $40\Delta_y$ or 0.6 in., (15.2 mm) where

$$\mu = \Delta_{80\%}/\Delta_y \quad (\text{F3.5-1})$$

$$\Delta_y = S_f Q_f \quad (\text{F3.5-2})$$

$\Delta_{80\%}$ = *post-peak deflection* at which the *connection* reaches 80% of its maximum strength (Q_f).

Q = force in *connection* at a specified displacement

Q_f = *structural connection* strength for sheet to support member as determined from AISI S905.

S_f = *structural connection* flexibility for sheet to support member as determined from AISI S905.

F3.5.1.2 Sidelap Connection Qualification

A *sidelap connection* conforming to all of the following is deemed acceptable for the purposes of Section F3.5.1 condition (7):

1. The stiffness and strength of the *connection* shall be established in accordance with AISI S100. Where mechanical fasteners are used, shear of the *connector* shall not be permitted as the *controlling limit state*.
2. The ductility and deformation capacity shall be established through testing conducted in accordance with AISI S905. Tests shall be conducted with one of the approved details from Section 7.1.1.2 of AISI S905. Reversed cyclic tests shall be performed for each *connection* in the *bare steel deck diaphragm configuration*. The minimum number of tests shall be in accordance with AISI S100 Section K2.1.1(a).
3. The mean ductility, μ , of the test specimens shall be greater than or equal to 20, and the mean residual force capacity, Q/Q_s , shall be at least 15% at a deformation defined as the maximum of $35\Delta_y$ and 0.5 in. (12.7 mm), where

$$\mu = \Delta_{80\%}/\Delta_y \quad (\text{F3.5-3})$$

$$\Delta_y = S_s Q_s \quad (\text{F3.5-4})$$

$\Delta_{80\%}$ = *post-peak deflection* at which the *connection* reaches 80% of its maximum strength (Q_s).

Q = force in *connection* at a specified displacement

Q_s = *sidelap connection* strength for sheet to support member as determined from AISI S905.

S_s = *sidelap connection* flexibility for sheet to support member as determined from AISI S905.

F3.5.2 Performance-Based Special Seismic Detailing

A *bare steel deck diaphragm* meeting the performance requirements specified in Sections F3.5.2.1 or F3.5.2.2, shall be deemed to provide special seismic detailing.

F3.5.2.1 Special Seismic Qualification by Cantilever Diaphragm Test

The stiffness and strength of the *diaphragm* shall be established in accordance with AISI S310. The ductility and the deformation capacity shall be established through testing conducted in accordance with AISI S907. A minimum of 3 reversed cyclic tests shall be performed at the boundaries of each range of selected *diaphragm configurations*. The mean ductility of the specimens shall be greater than or equal to 3, and the mean residual force capacity, P/P_{max} , shall be at least 40% at a deformation defined as the maximum of $4\Delta_y$ or a shear angle of 2%, where

$$\mu = \Delta_{80\%}/\Delta_y \quad (\text{F3.5-5})$$

$$\Delta_y = P_{max}/G' \quad (\text{F3.5-6})$$

$\Delta_{80\%}$ = *post-peak deflection* at which the *diaphragm configuration* reaches 80% of its maximum strength (P_{max}).

P = force in *diaphragm configuration* at a specified displacement

P_{max} = maximum strength (applied load) for tested *diaphragm configuration* as determined from AISI S907.

G' = shear stiffness of the diaphragm as determined from AISI S907.

Testing shall be subject to peer review per ASCE 7 Section 1.3.1.3.4, or review by a third party acceptable to the *authority having jurisdiction*. Documentation demonstrating compliance with this requirement shall be submitted for approval to the *authority having jurisdiction*.

F3.5.2.2 Special Seismic Qualification by Principles of Mechanics

A computational model shall be developed with geometry, details, and boundary conditions in accordance with AISI S907. The model shall include all applicable structural effects as listed in AISI S100 Section C1. In addition, the model shall capture the post-peak and cyclic behavior of any component that contributes to the forces developed or deformations undergone in the structure. The simulated ductility, μ , from the model shall be greater than or equal to 3, and the predicted mean residual force capacity, P/P_{max} , shall be at least 40% at a deformation defined as the maximum of $4\Delta_y$ or a shear angle of 2%, where

$$\mu = \Delta_{80\%}/\Delta_y \quad (\text{F3.5-7})$$

$$\Delta_y = P_{max}/G' \quad (\text{F3.5-8})$$

$\Delta_{80\%}$ = *post-peak deflection* at which the *diaphragm configuration* reaches 80% of its maximum strength (P_{max}).

P = force in *diaphragm configuration* at a specified displacement

P_{max} = maximum strength for modeled *diaphragm configuration*

G' = shear stiffness of the modeled diaphragm.

The developed model including supporting analysis and testing shall be subject to peer review per ASCE 7 Section 1.3.1.3.4, or review by a third party acceptable to the *authority having jurisdiction*. Documentation demonstrating compliance with this requirement shall be submitted for approval to the *authority having jurisdiction*.

SECTION 14.3.3 SEISMIC REQUIREMENTS FOR COMPOSITE STEEL AND CONCRETE STRUCTURES

Revise Section 14.3.3 as follows:

Where a response modification coefficient, R , in accordance with Table 12.2-1 is used for the design of systems of structural steel acting compositely with reinforced concrete, the structures shall be designed and detailed in accordance with the requirements of AISC 341. Coupled composite plate shear walls – concrete filled (CC-PSW/CF) shall be designed and detailed in accordance with the requirements of Section 14.3.5

SECTION 14.3.5 SEISMIC REQUIREMENTS FOR COUPLED COMPOSITE PLATE SHEAR WALLS – CONCRETE FILLED (CC-PSW/CF)

Add Section 14.3.5 with the following:

14.3.5.1 General

14.3.5.1.1 Scope

Coupled composite plate shear walls-concrete filled (CC-PSW/CF) shall be designed in accordance with this section. CC-PSW/CF consist of: (i) composite plate shear walls / concrete filled, and (ii) filled composite coupling beams.

The composite plate shear walls of CC-PSW/CF consist of planar, C-shaped, or I-shaped walls, where each wall element consists of two planar steel plates with concrete infill between them. Composite action between the plates and concrete infill is achieved using either tie bars or combination of tie bars and steel headed stud anchors. In each wall element, the two steel plates shall be of equal nominal thickness and connected using tie bars. A flange (or closure) plate shall be used at the open ends of the wall elements. No additional boundary elements (besides the closure plate) are required to be used with the composite walls. The wall height-to-length, h_w/L_w , ratio of the composite walls shall be greater than or equal to 4.

Coupling beams shall consist of concrete-filled built-up box sections of uniform cross-section along their entire length, and with width equal to or greater than the wall thickness at the connection. The clear length-to-section depth, L/d , ratios of the coupling beams shall be greater than or equal to 3 for all stories of the building, and less than or equal to 5 for at least 90% of the stories of the building.

14.3.5.1.2 Notation

The symbols listed below are to be used in addition to or as replacements for those in AISC 360 and AISC 341.

A_c Area of concrete in the composite cross-section, in.² (mm²)

E_c Modulus of elasticity of concrete

E_s Modulus of elasticity of steel = 29,000 ksi (200,000 MPa)

F_y Specified minimum yield stress, ksi (MPa). As used in the Specification, AISC 360, “yield stress” denotes either the minimum specified yield point (for those steels that have a yield point) or the specified yield strength (for those steels that do not have a yield point).

R_c Factor to account for expected strength of concrete = 1.5

R_y Ratio of the expected yield stress to the specified minimum yield stress, F_y

f'_c Specified compressive strength of concrete, ksi (MPa)

14.3.5.1.3 Glossary

The terms listed below are to be used in addition to those in AISC 360 and AISC 341. Some commonly used terms are repeated here for convenience.

Applicable building code. Building code under which the structure is designed. [AISC 360-16]

Available strength. Design strength or allowable strength, as applicable. [AISC 341-16]

Capacity-limited seismic load. The capacity-limited horizontal seismic load effect, E_{cl} , determined in accordance with these Provisions, substituted for E_{mh} , and applied as prescribed by the load combinations in the applicable building code. [AISC 341-16]

Composite. Condition in which steel and concrete elements and members work as a unit in the distribution of internal forces. [AISC 360-16]

Flexural buckling. Buckling mode in which a compression member deflects laterally without twist or change in cross-sectional shape. [AISC 360-16]

Load effect. Forces, stresses and deformations produced in a structural component by the applied loads. [AISC 360-16]

Nominal strength. Strength of a structure or component (without the resistance factor or safety factor applied) to resist load effects, as determined in accordance with the Specification, AISC 360. [AISC 341-16]

Required strength. Forces, stresses and deformations acting on a structural component, determined by either structural analysis, for the LRFD or ASD load combinations, as applicable, or as specified by this Specification or Standard. [AISC 360-16]

Resistance factor, ϕ . Factor that accounts for unavoidable deviations of the nominal strength from the actual strength and for the manner and consequences of failure. [AISC 341-16]

Steel anchor. Headed stud or hot rolled channel welded to a steel member and embodied in concrete of a composite member to transmit shear, tension, or a combination of shear and tension at the interface of the two materials. [AISC 360-16]

Stiffness. Resistance to deformation of a member or structure, measured by the ratio of the applied force (or moment) to the corresponding displacement (or rotation). [AISC 360-16]

14.3.5.2 Basics of Design

CC-PSW/CF designed in accordance with Section 14.3.5 shall provide significant inelastic deformation capacity through flexural plastic hinging in the composite coupling beams, and through flexural yielding at the base of the composite wall elements.

14.3.5.3 Analysis

14.3.5.3.1 Stiffness

The effective flexural and axial stiffness of filled composite coupling beams shall be calculated in accordance with AISC 360, Section I1.5. The effective flexural and axial stiffnesses of composite walls shall be calculated using cracked-transformed section properties corresponding to 60% of the calculated nominal flexural capacity. The effective shear stiffness of the composite coupling beams and walls shall be calculated using the uncracked shear stiffness of the composite cross-section.

14.3.5.3.2 Required Strength for Coupling Beams

Analyses in conformance with the applicable building code shall be performed to calculate the required strengths for the coupling beams

14.3.5.3.3 Required Strength for Composite Walls

The required strengths for the composite walls shall be determined using the capacity-limited seismic load effect in accordance with Section 14.3.5.3.4.

14.3.5.3.4 Capacity-Limited Seismic Load

The capacity-limited seismic load refers to the capacity-limited horizontal seismic load effect, E_{cl} , which shall be determined from an analysis in which all the coupling beams are assumed to develop plastic hinges at the both ends with expected flexural capacity of $1.2M_{p,exp}$, and the maximum overturning moment is amplified to account for the increase in lateral loading from the formation of the earliest plastic hinges to the formation of plastic hinges in all coupling beams over the full wall height. The earthquake-induced axial force in the walls for determining the required wall strength shall be calculated as the sum of the capacity-limited coupling beam shear forces, using Eq. (14.3.5-13), along the height of the structure. The portion of the maximum overturning moment resisted by coupling action shall be calculated as the couple caused by the wall axial forces associated with the coupling beam strengths. The remaining portion of the earthquake-induced overturning moment shall be distributed to the composite walls in accordance with their flexural stiffnesses, which shall be calculated using cracked-transformed section properties corresponding to 60% of the calculated nominal flexural capacity while accounting for the effects of simultaneous axial force. The required axial and flexural strengths for the composite walls shall be determined directly from this analysis, while the required wall shear strengths determined from this analysis shall be amplified by a factor of four.

14.3.5.4 Composite Wall Requirements

The composite wall shall be designed in accordance with the requirements of this section.

14.3.5.4.1 Minimum Area of Steel

The steel plates shall comprise at least 1% of the total composite cross-section area.

14.3.5.4.2 Steel Plate Slenderness Requirement for Composite Walls

In regions of flexural yielding (at the base), the steel plate slenderness ratio, b/t_p , shall be limited as follows.

$$\frac{b}{t_p} \leq 1.05 \sqrt{\frac{E_s}{R_y F_y}} \quad (14.3.5-1)$$

where,

b = largest unsupported length of the plate between rows of steel anchors or ties, in. (mm)

t_p = thickness of plate, in. (mm)

14.3.5.4.3 *Tie Spacing Requirement for Composite Walls.* The tie spacing to plate thickness ratio, S/t_p , shall be limited as follows:

$$\frac{S}{t_p} \leq 1.0 \sqrt{\frac{E_s}{2a + 1}} \quad (14.3.5-2)$$

$$a = 1.7 \left[\frac{t_{sc}}{t_p} - 2 \right] \left[\frac{t_p}{d_{te}} \right]^4 \quad (14.3.5-3)$$

where,

S = largest clear spacing of the ties

t_p = thickness of the steel plate

t_{sc} = thickness of the composite wall

d_{tie} = effective diameter of the tie

14.3.5.4.4 Tie-to-Plate Connection

The tie bar to steel plate connection shall develop the full yield strength of the tie bar.

14.3.5.5 Composite Coupling Beam Requirements

The composite coupling beam shall be designed in accordance with the requirements of this section.

14.3.5.5.1 Minimum Area of Steel

The cross-sectional area of the steel section shall comprise at least 1% of the total composite cross-section of the coupling beam.

14.3.5.5.2 Slenderness Requirement for Coupling Beams

The slenderness ratios of the flanges and webs of the filled composite coupling beam, b_c/t_f and h_c/t_w , shall be limited as follows:

$$\frac{b_c}{t_f} \leq 2.37 \sqrt{\frac{E_s}{R_y F_y}} \quad (14.3.5-4)$$

$$\frac{h_c}{t_w} \leq 2.66 \sqrt{\frac{E_s}{R_y F_y}} \quad (14.3.5-5)$$

where,

b_c = clear unsupported width of the coupling beam flange plate

h_c = clear unsupported width of the coupling beam web plate

t_f = thickness of the coupling beam flange plate

t_w = thickness of the coupling beam web plates

14.3.5.5.3 Flexure-Critical Coupling Beams

The composite coupling beams shall be proportioned to be flexure critical with design shear strength, ϕV_n , as follows:

$$\phi V_n \geq \frac{2.4 M_{p,exp}}{L_{cb}} \quad (14.3.5-6)$$

where,

\mathcal{F}_n = design shear strength of composite coupling beam calculated in accordance with Section 14.3.5.7.2

$M_{p,exp}$ = expected flexural capacity of composite coupling beam calculated in accordance with Section 14.3.5.7.1 while using the expected yield strength, $R_y F_y$, for steel and the expected compressive strength $R_c f'_c$ for concrete

L_{cb} = clear span length of the coupling beam

14.3.5.6 Composite Wall Strength

The nominal strengths of composite walls shall be calculated in accordance with this section. The available strengths shall be calculated using resistance factor (ϕ) equal to 0.90.

14.3.5.6.1 Tensile Strength

The nominal tensile strength, P_n , shall be determined for the limit state of yielding as:

$$P_n = A_s F_y \quad (14.3.5-7)$$

where, A_s = area of steel plates in the wall cross-section

14.3.5.6.2 Comprehensive Strength

The nominal compressive strength shall be determined for the limit state of flexural buckling in accordance with the AISC 360, Section I2.1b. The value of flexural stiffness from Section 14.3.5.3.1 shall be used along with the section axial load capacity, P_{no} , determined as follows:

$$P_{no} = A_s F_y + 0.85 f'_c A_c \quad (14.3.5-8)$$

14.3.5.6.3 Flexural Strength

The nominal flexural strength shall be determined as the moment corresponding to plastic stress distribution over the composite cross-section. Steel components shall be assumed to have reached a yield stress of F_y in either tension or compression, and concrete components in compression due to axial force and/or flexure shall be assumed to have reached a stress of $0.85 f'_c$, where f'_c is the specified compressive strength of concrete, ksi.

14.3.5.6.4 Combined Axial Force and Flexure

The nominal strength of composite walls subjected to combined axial force and flexure shall account for their interaction in accordance with the plastic stress distribution method of AISC 360, Section I1.2a or the effective stress-strain method of AISC 360, Section I1.2d.

14.3.5.6.5 Shear Strength

$$V_n = \frac{K_s + K_{sc}}{\sqrt{3K_s^2 + K_{sc}^2}} \times A_{sw} F_y \quad (14.3.5-9)$$

The nominal in-plane shear strength, V_n , shall be determined as follows:

where,

$$K_s = GA_{sw} \quad (14.3.5-10)$$

$$K_{sc} = \frac{0.7(E_c A_c)(E_s A_{sw})}{4E_s A_{sw} + E_c A_c} \quad (14.3.5-11)$$

where,

A_{sw} = Area of the steel plates in the direction of in-plane shear

G = Shear modulus of steel, ksi (MPa)

14.3.5.7 Composite Coupling Beam Strength

The nominal strengths of composite coupling beams shall be calculated in accordance with this section. The available strengths shall be calculated using resistance factor (ϕ) equal to 0.90.

14.3.5.7.1 Flexible Strength

The nominal flexural strength of coupling beams shall be determined as the moment corresponding to plastic stress distribution over the composite cross-section. Steel components shall be assumed to have reached a yield stress of F_y in either tension or compression, and concrete components in compression due to axial force and/or flexure shall be assumed to have reached a stress of $0.85f'_c$.

14.3.5.7.2 Shear Strength

The nominal shear strength, V_n , of coupling beams shall account for the contributions of the steel webs and concrete infill and be determined as follows:

$$V_n = 0.6A_w F_y + 0.06A_c \sqrt{f'_c} \quad (14.3.5-12)$$

where,

A_w = Area of coupling beam steel web plates

14.3.5.8 Coupling Beam-to-Wall Connections

The coupling beam-to-wall connections shall be design in accordance with the requirements of this section.

14.3.5.8.1 Required Flexural Strength

The required flexural strength, M_u , for the coupling beam-to-wall connection shall be 120% of the expected flexural capacity of the coupling beam ($M_{p,exp}$).

14.3.5.8.2 Required Shear Strength

The required shear strength, V_u , for the coupling beam-to-wall connection shall be determined using capacity-limited seismic load effect as follows:

$$V_u = 2 (1.2 M_{p,exp}) / L_{cb} \quad (14.3.5-13)$$

where,

$M_{p,exp}$ = expected flexural capacity of composite coupling beam calculated using expected yield strength, $R_y F_y$, for steel and the expected compressive strength $R_c f'_c$ for concrete

L_{cb} = clear span length of the coupling beam

14.3.5.8.3 Rotation Capacity

The coupling beam-to-wall connection shall be detailed to allow the coupling beam to develop a plastic hinge rotation capacity of 0.030 rad before flexural strength decreases to 80% of the flexural plastic strength of the beam. Connection details that have been previously demonstrated to have adequate plastic rotation capacity shall be approved for use. The available plastic rotation capacity of a coupling beam using other connection details shall be verified through testing, advanced analysis, or combination thereof.

14.3.5.9 Composite Wall-to-Foundation Connections

Where the composite walls are connected directly to the foundation at the point of maximum moment in the walls, the composite wall-to-foundation connections shall be designed in accordance with the requirements of this section.

14.3.5.9.1 Required Strengths

The required strengths for the composite wall-to-foundation connections shall be determined using the capacity-limited seismic load effect. The coupling beams shall be assumed to have developed plastic hinges at both ends with the expected flexural capacity of $1.2M_{p,exp}$. The composite walls shall also be assumed to have developed plastic hinges at the base with expected flexural capacity of $1.2M_{p,exp}$, while accounting for the effects of simultaneous axial force. The required shear strength for the composite wall-to-foundation connections shall be equal to the required shear strength for the composite walls calculated in accordance with Section 14.3.5.3.4.

14.3.5.10 Protected Zones

The requirements for protected zones shall be in accordance with AISC 341 Section D1.3 and Section I2.1. The following regions shall be designated as protected zones:

- a. The regions at ends of the coupling beams subject to inelastic straining.
- b. The regions at the base of the composite walls subject to inelastic straining.

14.3.5.11 Demand Critical Welds in Connections

The requirements for demand critical welds shall be in accordance with AISC 341 Section A3.4b and Section I2.3. Unless demonstrated through testing, the welds connecting the coupling beam flanges and web plates to composite wall steel plates shall be demand critical and shall satisfy the applicable requirements.

Where located within the protected zones identified in Section 14.3.5.10, the following welds shall be demand critical and shall satisfy the applicable requirements:

- a. Welds connecting the composite wall flange (closure) plates to the web plates
- b. Welds connecting the coupling beam web plates to flange plates in built-up box sections
- c. Welds in the composite wall steel plate splices
- d. Welds at composite wall steel plate-to-base plate connections

SECTION 14.5.2 SEISMIC REQUIREMENTS FOR CROSS LAMINATED TIMBER SHEAR WALLS

Add the following new section 14.5.2 as follows:

14.5.2.1 Scope

These provisions shall be used for the design and construction of structural cross-laminated timber (CLT) members and connections that are part of the seismic-force-resisting system. Capacity design principles are employed to ensure development of the expected shear capacity of the prescribed nailed connectors of the CLT shear wall. The provisions provided herein shall be applied in combination with the requirements of the AWC SDPWS, AWC NDS including Appendix E, ASCE 7, and the applicable building code.

14.5.2.1.1 Notation

The symbols used in Section 14.5.2 have the following meaning:

C_G = CLT panel specific gravity adjustment factor

G = specific gravity

$GA_{\text{eff (in-plane)}}$ = Effective in-plane shear stiffness of the CLT panel, lb/in (N/mm) of panel length

$EI_{\text{eff (in-plane)}}$ = Effective in-plane bending stiffness of the CLT panel, lb-in² (N-mm²)

$V_{\text{nail load}}$ = load per nail, lbf (N)

h = CLT panel height, ft (mm)

b_s = individual CLT panel length, ft (mm)

$\sum b_s$ = sum of individual CLT panel lengths, ft (mm)

n = number of angle connectors along bottom of panel face

v_s = nominal unit shear capacity, plf (N/mm)

v = induced unit shear, plf (N/mm)

Δ_a = vertical deformation of the wall hold-down system (including but not limited to fastener slip, device elongation, rod elongation, and uncompensated shrinkage plus the vertical compression deformation), the effects of which are measured at the ends of the shear wall and associated with induced unit shear in the shear wall, in. (mm)

$\Delta_{\text{nail slip},h}$ = horizontal slip of nailed connections at top and bottom of panel, in. (mm)

$\Delta_{\text{nail slip},v}$ = vertical slip of nailed connectors at vertical adjoining panel edge, in. (mm)

δ_{sw} = shear wall deflection, in. (mm)

ϕ_D = resistance factor for in-plane shear

14.5.2.1.2 Terminology

The terms listed below are to be used in addition to those in AWC SDPWS.

CROSS LAMINATED TIMBER SHEAR WALL. A shear wall employing cross laminated timber panels and meeting the requirements of 14.5.2.

CROSS LAMINATED TIMBER SHEAR WALL WITH SHEAR RESISTANCE PROVIDED BY HIGH ASPECT RATIO PANELS ONLY. A cross laminated timber shear wall employing CLT panels of high aspect ratio in accordance with requirements of 14.5.2.3.7.

PLATFORM CONSTRUCTION. A method of construction by which roof and floor framing bears on load bearing walls that are not continuous through the story levels or floor framing.

14.5.2.2 Application Requirements

The design and construction of the CLT seismic force-resisting system (SFRS) shall comply with all of the following:

1. The method of construction shall be platform construction in accordance with the following:
 - a. CLT floor panels bear on and are supported by CLT shear walls that are part of the designated SFRS. Additional gravity support is permitted to be provided by other gravity framing system elements including but not limited to CLT walls that are not part of the designated SFRS, beams, columns, and light-frame walls.
 - b. CLT floor panels are designed as the floor diaphragm to distribute lateral loads to the CLT shear walls.
2. CLT walls shall be classified as either (1) part of the designated SFRS (i.e. CLT shear wall) or (2) not part of the designated SFRS.
3. CLT walls that are not part of the designated SFRS shall meet the following requirements:
 - a. CLT panels forming either a single-panel or multi-panel wall shall have an aspect ratio, h/b_s , that is not less than the aspect ratio used for CLT shear wall panels in accordance with 14.5.2.3.1 or 14.5.2.3.7.
 - b. Shear connections at the top and bottom of CLT wall panels shall be in accordance with 14.5.2.3.2. Where shear connections are provided at adjoining vertical panel edges to form a multi-panel CLT wall, such connections shall be in accordance with 14.5.2.3.3. Hold-down systems in accordance with 14.5.2.3.4 are not required.
4. CLT walls that are not part of the designated SFRS shall be designed so that the action or failure of those elements will not impair the vertical load and seismic force-resisting capability of the designated SFRS.
 - a. The design shall provide for the effect of the CLT walls that are not part of the designated SFRS on the structural system at deformations corresponding to the design story drift, the distribution of forces to the structural system, and the corresponding load path to the final point of resistance; this shall be achieved by design for the most critical demands to vertical gravity load supporting elements, vertical SFRS elements, and diaphragms, and their load paths, determined in accordance with both of the following:
 - i. Force and deformation demands determined including in the analysis CLT shear walls that are part of the designated SFRS, but neglecting in-plane shear strength and stiffness of CLT walls that are not part of the designated SFRS, and
 - ii. Force and deformation demands determined including in the analysis both CLT shear walls that are part of the designated SFRS and CLT walls that are not part of the designated SFRS.
 - b. The effects of CLT walls that are not part of the designated SFRS shall be considered where determining whether a structure has one or more of the irregularities defined in 12.3.2 based on the two analysis cases in accordance with item 4a.
 - c. Where the fundamental period of the structure is calculated in accordance with 12.8.2 using the structural properties and deformational characteristics, it shall

include the effects of stiffness of CLT walls that are not part of the designated SFRS.

- d. For the purpose of Items 4a, 4b and 4c, CLT wall panels that are classified as not part of the designated SFRS shall be modeled assuming they develop in-plane shear strength and stiffness associated with CLT shear walls of the same construction.
5. Shear distribution to individual CLT shear walls in a wall line shall provide the same calculated deflection in each shear wall (i.e. distribution of loads based on relative stiffness).
6. The dead load considered in the overturning design of each individual CLT panel within the CLT shear wall shall be limited to the dead load supported by or directly above the individual CLT panel.
7. CLT shear walls shall be full height within each story. CLT shear walls are not permitted to be designed as Force-Transfer Around Openings (FTAO) shear walls or as Perforated Shear Walls.
8. The nominal unit shear capacity assigned to CLT shear walls shall not include contributions from connections other than those shear connections prescribed in 14.5.2.3.2 and 14.5.2.3.3.
9. Seismic criteria specific to light-frame construction shall not apply to the design of CLT shear walls and CLT diaphragms.

14.5.2.3 CLT Shear Wall Requirements

14.5.2.3.1 CLT panels

CLT panels used in CLT shear walls shall be designed in accordance with the AWC NDS and the following requirements:

1. CLT in-service moisture content shall be less than 16% and specific gravity, G , shall be 0.35 or greater.
2. CLT panels forming either a single-panel or multi-panel shear wall shall have aspect ratio, h/b_s , not greater than 4 nor less than 2. All CLT panels forming a multi-panel shear wall shall have the same panel height, h , and individual panel length, b_s .
3. CLT panels shall be a minimum of 3.5 in. (88.9mm) in thickness. Where angle connectors or vertical edge connectors are installed in both faces of the CLT panel and are directly opposed, CLT panels shall be a minimum of 6.875 in. (174.6 mm) in thickness so that nails from opposing faces do not overlap.
4. Holes, notches and other modifications to CLT panels shall not be permitted unless the effects of removal of material on load carrying capacity of the CLT panel is determined by an approved rational analysis.

14.5.2.3.2 Top- and bottom-of-wall angle connector

Shear connections at the top and bottom of CLT shear walls shall be composed of prescribed steel angle connectors, nails, and bolts in accordance with the following requirements:

1. Angle connector shall be fabricated from 0.105 in. (2.67 mm) thickness, ASTM A653 Grade 33 steel sheet with the geometry as illustrated in Figure 14.5.2.3.2.

2. Vertical legs of angle connectors shall be fastened to wall panel using (8) 16d carbon steel box nails (3.5 in. length x 0.135 in. shank diameter x 0.344 in. head diameter; 88.9 mm length x 3.43 mm shank diameter x 8.74 mm head diameter) with bright finish in accordance with ASTM F1667 including Supplementary Requirements of ASTM F1667 S1 Nail Bending Yield Strength.
3. Horizontal legs of angle connectors shall be fastened to supporting elements (e.g. CLT floor or roof panels, concrete foundation elements, or roof framing elements other than CLT) with (2) five-eighths in. diameter x 4-one-half in. long (minimum) (15.9 mm diameter x 114.3 mm long) bolts to provide minimum 4-one-half in. (114.3 mm) bearing length with washer per ASME B18.21.1, or (2) five-eighths in. (15.9 mm) full-body diameter lag screws with 2-three-fourths in. (69.85 mm) thread penetration (minimum) excluding tapered tip and 3-one-eighth in. (79.4 mm) unthreaded shank length (minimum) to provide minimum 5-seven-eighths in. (149.2 mm) bearing length and with washer per ASME B18.21.1. Bolts and lag screws shall be ASTM A307 Grade A or higher. The anchorage, foundation, and other supporting elements shall be capable of resisting a concurrent tension force and shear force transmitted through horizontal leg fasteners, with force in each of the two orthogonal directions equal to the connector nominal shear capacity. The design of the five-eighths in. (15.9 mm) diameter anchor to concrete foundation or other concrete elements shall be in accordance with ACI 318 and the prescribed loading above shall be considered to meet the ductile yield mechanism requirement of ACI 318.
4. Angle connectors at the bottom and top of wall panels shall extend to within 12 in. of each end of each panel of a single or multi-panel shear wall.
5. Each wall panel shall have at least two angle connectors at the top and bottom. The same number of angle connectors shall be provided at the top and bottom of each wall panel.

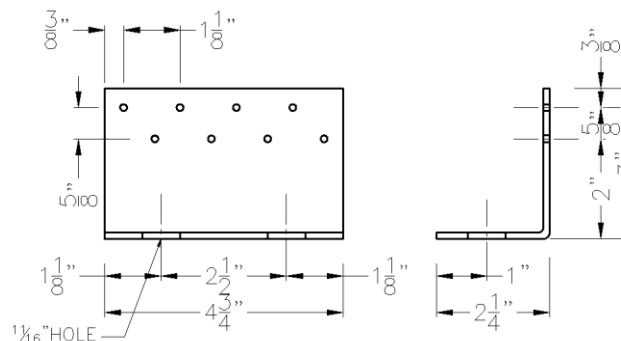

FIGURE 14.5.2.3.2. Top- and Bottom-of-Wall Angle Connector

14.5.2.3.3 Adjoining panel edge connector

For CLT multi-panel shear walls, shear connections at adjoining vertical panel edges of CLT wall panels shall be composed of prescribed steel plate connectors and nails in accordance with the following requirements:

1. Plate connector shall be fabricated from 0.105 in. (2.67 mm) thickness, ASTM A653 Grade 33 steel sheet with the geometry as illustrated in Figure 14.5.2.3.3.
2. Plate connectors shall be fastened to each wall panel using (8) 16d carbon steel box nails (3.5 in. length x 0.135 in. shank diameter x 0.344 in. head diameter; 88.9 mm length x

3.4 mm shank diameter x 8.74 mm head diameter) with bright finish in accordance with ASTM F1667 including Supplementary Requirements of ASTM F1667 S1 Nail Bending Yield Strength.

3. The number of plate connectors required at adjoining vertical edges of CLT panels shall equal the number of angle connectors along the bottom edge of the wall panel times the CLT panel aspect ratio, h/b_s , rounded up to the next whole number.

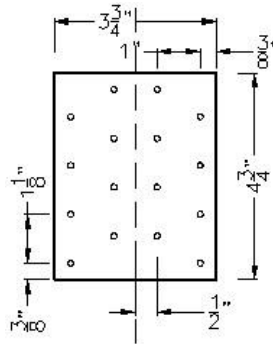

FIGURE 14.5.2.3.3. Adjoining Panel Edge Connector

14.5.2.3.4 Hold-down system

Each end of each shear wall shall be provided with a hold-down system. Hold-down systems shall comply with the following:

1. Hold-down systems shall consist of continuous tie-rod systems or conventional hold-down devices that use threaded anchor rods and nail, screw or bolt attachment to the CLT panel.
2. Where continuous tie-rod systems are used, rods at each level shall be designed for cumulative overturning tensile forces and bearing plates shall be provided at the floor level above each story. Tie-rod elongation or conventional hold-down device deformation for each story shall not exceed 0.185 inches when applying strength design load combinations of 2.3.6.
3. The hold-down system including anchorage to the foundation shall be designed to resist not less than 2.0 times the forces associated with the design shear capacity of the CLT shear wall determined in accordance with 14.5.2.6. Connections between the hold-down device and CLT panel shall comply with net section tension rupture, row tear-out, group tear-out in accordance with AWC NDS Appendix E. The anchorage to foundation shall be designed in accordance with ACI 318.

14.5.2.3.5 Compression zone

The length of the compression zone for overturning-induced compression forces shall be determined to satisfy static equilibrium assuming a uniform distribution of bearing stress in the compression zone. For multi-panel shear walls, the compression zone shall be contained within the outermost wall panel. CLT wall panel resistance to induced axial compression forces shall be determined using cross section dimensions associated with the compression zone.

14.5.2.3.6 Other load path connections to CLT wall panels

Connections to CLT wall panels in addition to those connections prescribed in 14.5.2.3.2 and 14.5.2.3.3 shall be provided in accordance with AWC SDPWS 4.1.1 to provide a continuous load path. Load path

connections to CLT wall panels shall be with dowel-type fasteners designed to develop Mode III or Mode IV yielding, and comply with net section tension rupture, row tear-out, group tear-out in accordance with AWC NDS Appendix E. Screws (e.g. wood screws and lag screws) shall not be used in supplemental top and bottom of wall connections to supporting elements. Angle connectors prescribed in 14.5.2.3.2 shall not be considered in design to resist out-of-plane forces.

14.5.2.3.7 CLT shear walls with shear resistance provided by high aspect ratio panels only

CLT shear walls with shear resistance provided by high aspect ratio panels only shall meet all requirements applicable for CLT shear walls and the following:

- a. all CLT wall panels used as part of the designated seismic force-resisting system shall have aspect ratio, h/b_s , equal to 4, and
- b. all CLT wall panels that are not part of the designated seismic force-resisting system shall have aspect ratio, h/b_s , not less than 4.

14.5.2.4 Deflection

CLT shear wall deflection, δ_{SW} , shall be calculated by use of the following equation:

$$\delta_{SW} = \frac{576vb_s h^3}{EI_{eff} \text{ (in-plane)}} + \frac{vh}{GA_{eff} \text{ (in-plane)}} + 3\Delta_{nail slip,h} + 2\Delta_{nail slip,v} \frac{h}{b_s} + \Delta_a \frac{h}{\sum b_s} \quad (14.5.2-1)$$

For SI:

$$\delta_{SW} = \frac{vb_s h^3}{3EI_{eff} \text{ (in-plane)}} + \frac{vh}{GA_{eff} \text{ (in-plane)}} + 3\Delta_{nail slip,h} + 2\Delta_{nail slip,v} \frac{h}{b_s} + \Delta_a \frac{h}{\sum b_s} \quad (14.5.2-1b)$$

where

v = induced unit shear, plf (N/mm)

$EI_{eff} \text{ (in-plane)}$ = Effective in-plane bending stiffness of the of CLT panel, lb-in² (N-mm²)

$GA_{eff} \text{ (in-plane)}$ = Effective in-plane shear stiffness of the CLT panel, lb/in of panel length (N/mm)

h = CLT panel height, ft (mm)

b_s = individual CLT panel length, ft, (mm)

$\sum b_s$ = sum of individual CLT panel lengths, ft (mm)

$\Delta_{nail slip,h} = \frac{V_{nail load}}{6700}$, in.; $\frac{V_{nail load}}{1174}$, mm.

$\Delta_{nail slip,v} = \Delta_{nail slip,h}$, in. (= 0 for a single panel shear wall)

$V_{nail load}$ = load per nail, lbs (calculated as total shear load at base of wall divided by total number of nails in base connectors) (N)

Δ_a = vertical deformation of the wall hold-down system (including but not limited to fastener slip, device elongation, rod elongation, and uncompensated shrinkage plus the vertical compression deformation), the effects of which are measured at the ends of the shear wall and associated with induced unit shear in the shear wall, in.

14.5.2.5 Nominal unit shear capacity

Nominal unit shear capacity, v_s , shall be in accordance with Eq. (14.5.2-2). Where both faces of a panel are provided with angle connectors in accordance with 14.5.2.3.2, the nominal unit shear capacity shall be permitted to be taken as the sum of the nominal unit shear capacities of each face.

$$v_s = n \left(\frac{2605}{b_s} \right) (C_G) \quad (14.5.2-2)$$

For SI:

$$v_s = n \left(\frac{11587}{b_s} \right) (C_G) \quad (14.5.2-2b)$$

where

n = number of angle connectors along bottom of panel face

2605 = connector nominal shear capacity in accordance with NDS (lbs) (11587 N)

b_s = individual CLT panel length, ft (mm)

C_G = CLT panel specific gravity adjustment factor. $C_G = 1.0$ for $G \geq 0.42$. $C_G = 0.86$ for $G = 0.35$. Linear interpolation shall be permitted to be used to determine values of C_G for G between 0.35 and 0.42.

14.5.2.6 ASD and LRFD design unit shear capacities

For seismic design, the LRFD factored unit shear resistance shall be determined by multiplying the nominal unit shear capacity by a resistance factor, ϕ_D , of 0.50. For seismic design, the ASD allowable unit shear capacity shall be determined by dividing the nominal unit shear capacity by the ASD reduction factor of 2.8.

14.5.2.7 Diaphragm Requirements

CLT floor diaphragms shall be designed in accordance with principles of mechanics using values of fastener and member strength in accordance with AWC NDS including Appendix E. Fasteners used in floor panel joints for diaphragm shear shall be designed to develop Mode III or Mode IV yielding in accordance with AWC NDS 12.3.1. Other wood elements, steel parts, and wood or steel chord splice connections shall be designed for 2.0 times the forces associated with the design capacity of the CLT diaphragm except that a factor of 1.5 shall be permitted to be used for design of chord splice fasteners limited by Mode III or Mode IV fastener yielding in accordance with AWC NDS 12.3.1. Fasteners used in floor panel joints for diaphragm shear shall not be used to meet requirements for continuity of diaphragm tension chords and collectors. CLT diaphragm deflection shall be determined using established principles of engineering mechanics.

Page intentionally left blank.

CHAPTER 15, SEISMIC DESIGN REQUIREMENTS FOR NONBUILDING STRUCTURES

(Modifications)

SECTION 15.2 NONBUILDING STRUCTURES CONNECTED BY NONSTRUCTURAL COMPONENTS TO OTHER ADJACENT STRUCTURES

Add Section 15.2 with the following:

15.2.1 Nonbuilding Structures Connected by Nonstructural Components to Other Adjacent Structures

For nonbuilding structures connected by nonstructural components to other adjacent structures, an analysis combining the structural characteristics of the nonbuilding structure, the adjacent structure, and the connecting nonstructural components in accordance with the requirements of Chapter 12 or Section 15.5, as appropriate shall be performed to determine the seismic forces.

EXCEPTION: Regular nonbuilding structures connected to regular adjacent structures are permitted to be designed independently, with the tributary weight of the nonstructural components considered in the determination of the effective seismic weight, W , for any of the following conditions:

- a. The ratio of the fundamental period of the nonbuilding structure to the adjacent connected structure in the direction of motion is greater than 0.9 and less than 1.1.
- b. The ratio of the fundamental period of the nonbuilding structure to the adjacent structure in the direction of motion is greater than 0.8 and less than 1.2 and the ratio of the effective seismic weight of the nonbuilding structure and the adjacent structure is greater than 0.8 and less than 1.2.
- c. The ratio of the stiffness of the connecting nonstructural components to the nonbuilding structure in the direction of motion and the ratio of the stiffness of the connecting nonstructural components to the adjacent structure in the direction of motion are both less than 0.2.

15.2.2 Architectural, Mechanical, and Electrical Components Spanning Between Nonbuilding Structures

Architectural, mechanical, and electrical components spanning between nonbuilding structures shall be designed in accordance with Chapter 13 of this standard.

SECTION 15.3 NONBUILDING STRUCTURES SUPPORTED BY OTHER STRUCTURES

Revise Section 15.3 as follows:

Where nonbuilding structures identified in Table 15.4-2 are supported by other structures and nonbuilding structures are not part of the primary seismic force-resisting system, one of the following methods shall be used.

15.3.1 Less Than 20% Combined Weight Condition

Supported Nonbuilding Structures with Less Than 20% Combined Weight. For the condition where the weight of the nonbuilding structure is less than 20% of the combined effective seismic weights of the nonbuilding structure and supporting structure, the design seismic forces of the nonbuilding structure shall be determined in accordance with Chapter 13 where the values of C_{AR} and R_{po} shall be determined in accordance with Section 13.1.6. The supporting structure shall be designed in accordance with the

requirements of Chapter 12 or Section 15.5, as appropriate, with the weight of the nonbuilding structure considered in the determination of the effective seismic weight, W .

15.3.2 Supported Nonbuilding Structures with Greater Than or Equal to 20% Combined Weight

For the condition where the weight of the nonbuilding structure is equal to or greater than 20% of the combined effective seismic weights of the nonbuilding structure and supporting structure, an analysis combining the structural characteristics of both the nonbuilding structure and the supporting structures shall be performed to determine the seismic design forces. The combined structure shall be designed in accordance with Section 15.5 with the R value of the combined system taken as the lesser R value of the nonbuilding structure or the supporting structure. The nonbuilding structure and attachments shall be designed for the forces determined for the nonbuilding structure in the combined analysis.

EXCEPTIONS:

- a. Where the ratio of the fundamental period of the nonbuilding structure to the supporting structure (including the lumped weight of the nonbuilding structure) is greater than 2.0, the nonbuilding structure is permitted to be designed in accordance with the requirements of Chapter 12 or Section 15.5, as appropriate, with the nonbuilding structure modeled as attached to a rigid base.
- b. Where the ratio of the fundamental period of the nonbuilding structure to the supporting structure (including the lumped weight of the nonbuilding structure) is less than 0.5, the supporting structure is permitted to be designed in accordance with the requirements of Chapter 12 or Section 15.5, as appropriate, with the weight of the nonbuilding structure considered in the determination of the effective seismic weight, W .

15.3.3 Architectural, Mechanical, and Electrical Components Supported by Nonbuilding Structures

Architectural, mechanical, and electrical components supported by nonbuilding structures shall be designed in accordance with Chapter 13 of this standard.

Page intentionally left blank.

CHAPTER 18, SEISMIC DESIGN REQUIREMENTS FOR STRUCTURES WITH DAMPING SYSTEMS

(Modifications)

SECTION 18.2.3.2 EQUIVALENT LATERAL FORCE PROCEDURE

Revise Section 18.2.3.2 as follows:

The equivalent lateral force procedure of Section 18.7.2 is permitted to be used for analysis and design provided that all of the following conditions apply:

1. In each principal direction, the damping system has at least two damping devices in each story, configured to resist torsion.
2. The total effective damping of the fundamental mode, $\beta_{mD}(m=1)$, of the structure in the direction of interest is not greater than 35% of critical.
3. The seismic force-resisting system does not have horizontal irregularity Type 1a or 1b (Table 12.3-1) or vertical irregularity Type 1a, 1b, or 2 (Table 12.3-2).
4. Floor diaphragms are rigid as defined in Section 12.3.1.
5. The height of the structure above the base does not exceed 100 ft (30 m).
6. The S_I value for the site is less than 0.6.

Page intentionally left blank.

CHAPTER 19, SOIL-STRUCTURE INTERACTION FOR SEISMIC DESIGN

(Modifications)

SECTION 19.3 FOUNDATION EFFECTS

Revise Section 19.3 as follows:

19.3.1 Foundation Damping Requirements

Foundation damping effects are permitted to be considered through direct incorporation of soil hysteretic damping and radiation damping in the mathematical model of the structure.

The procedures of this section shall not be used for the following cases:

1. A foundation system consisting of discrete footings that are not interconnected and that are spaced less than the larger dimension of the supported lateral force-resisting element in the direction under consideration.
2. A foundation system consisting of, or including, deep foundations such as piles or piers.
3. A foundation system consisting of structural mats interconnected by concrete slabs that are characterized as flexible in accordance with Section 12.3.1.3 or that are not continuously connected to grade beams or other foundation elements.

19.3.2 Effective Damping Ratio

The effects of foundation damping shall be represented by the effective damping ratio of the soil–structure system, β_0 , determined in accordance with Eq. (19.3-1):

$$\beta_0 = \beta_f + \frac{\beta}{(\tilde{T}/T)_{\text{eff}}^2} \leq 0.20 \quad (19.3-1)$$

where

β_f = effective viscous damping ratio relating to foundation–soil interaction;

β = effective viscous damping ratio of the structure, taken as 5% unless otherwise justified by analysis; and

$(\tilde{T}/T)_{\text{eff}}$ = effective period lengthening ratio defined in Eq. (19.3-2).

The effective period lengthening ratio shall be determined in accordance with Eq. (19.3-2):

$$\left(\frac{\tilde{T}}{T}\right)_{\text{eff}} = \left\{ 1 + \frac{1}{\mu} \left[\left(\frac{\tilde{T}}{T}\right)^2 - 1 \right] \right\}^{0.5} \quad (19.3-2)$$

where

μ = expected ductility demand. For equivalent lateral force or modal response spectrum analysis procedures, μ is the maximum base shear divided by the elastic base shear capacity; alternately, μ is permitted to be taken as R/Ω_0 , where R and Ω_0 are per Table 12.2-1. For the response history analysis

procedures, μ is the maximum displacement divided by the yield displacement of the structure measured at the highest point above grade.

Table 19.3-1 Effective Shear Wave Velocity Ratio (v_s / v_{so})

Site Class	Effective Peak Acceleration, $S_{DS} / 2.5^a$			
	$S_{DS}/2.5 = 0$	$S_{DS}/2.5=0.1$	$S_{DS}/2.5 = 0.4$	$S_{DS}/2.5 \geq 0.8$
A	1.00	1.00	1.00	1.00
B	1.00	1.00	0.97	0.95
BC	1.00	0.98	0.92	0.86
C	1.00	0.97	0.87	0.77
CD	1.00	0.96	0.79	0.50
D	1.00	0.95	0.71	0.32
DE	1.00	0.86	0.40	0.18
E	1.00	0.77	0.22	<i>b</i>
F	<i>b</i>	<i>b</i>	<i>b</i>	<i>b</i>

^aUse straight-line interpolation for intermediate values of $S_{DS}/2.5$.

^bSite-specific geotechnical investigation and dynamic site response analyses shall be performed.

The foundation damping ratio caused by soil hysteretic damping and radiation damping, β_f , is permitted to be determined in accordance with Eq. (19.3-3) or by other approved methods.

$$\beta_f = \left[\frac{(\tilde{T}/T)^2 - 1}{(\tilde{T}/T)^2} \right] \beta_s + \beta_{rd} \quad (19.3-3)$$

where

β_s = soil hysteretic damping ratio determined in accordance with Section 19.3.5, and

β_{rd} = radiation damping ratio determined in accordance with Section 19.3.3 or 19.3.4.

If a site more than a depth B below the base of the building consists of a relatively uniform layer of depth, D_s , overlaying a very stiff layer with a shear wave velocity more than twice that of the surface layer then the damping values, β_r , in Eq. (19.3-3) shall be replaced by β'_s , per Eq. (19.3-4):

$$\beta'_s = \left(\frac{4D_s}{v_s \tilde{T}} \right)^4 \beta_s \quad (19.3-4)$$

19.3.3 Radiation Damping for Rectangular Foundations

The effects of radiation damping for structures with a rectangular foundation plan shall be represented by the effective damping ratio of the soil–structure system, β_r , determined in accordance with Eq. (19.3-5):

$$\beta_{rd} = \frac{1}{(\tilde{T}/T_y)^2} \beta_y + \frac{1}{(\tilde{T}/T_{xx})^2} \beta_{xx} \quad (19.3-5)$$

$$T_y = 2\pi \sqrt{\frac{M^*}{K_y}} \quad (19.3-6)$$

$$T_{xx} = 2\pi \sqrt{\frac{M^* (h^*)^2}{\alpha_{xx} K_{xx}}} \quad (19.3-7)$$

$$K_y = \frac{GB}{2-\nu} \left[6.8 \left(\frac{L}{B} \right)^{0.65} + 0.8 \left(\frac{L}{B} \right) + 1.6 \right] \quad (19.3-8)$$

$$K_{xx} = \frac{GB^3}{1-\nu} \left[3.2 \left(\frac{L}{B} \right) + 0.8 \right] \quad (19.3-9)$$

$$\beta_y = \left[\frac{4(L/B)}{(K_y/GB)} \right] \left[\frac{a_0}{2} \right] \quad (19.3-10)$$

$$a_0 = \frac{2\pi B}{\tilde{T}\nu_s} \quad (19.3-11)$$

$$\beta_{xx} = \left[\frac{(4\Psi/3)(L/B)a_0^2}{\left(\frac{K_{xx}}{GB^3} \right) \left[\left(2.2 - \frac{0.4}{(L/B)^3} \right) + a_0^2 \right]} \right] \left[\frac{a_0}{2\alpha_{xx}} \right] \quad (19.3-12)$$

$$\Psi = \sqrt{\frac{2(1-\nu)}{(1-2\nu)}} \leq 2.5 \quad (19.3-13)$$

$$\alpha_{xx} = 1.0 - \left[\frac{(0.55 + 0.01\sqrt{(L/B)-1})a_0^2}{\left(2.4 - \frac{0.4}{(L/B)^3} \right) + a_0^2} \right] \quad (19.3-14)$$

where

M^* = effective modal mass for the fundamental mode of vibration in the direction under consideration;

h^* = effective structure height taken as the vertical distance from the foundation to the centroid of the first mode shape for multistory structures. Alternatively, h^* is permitted to be approximated as 70% of the total structure height for multistory structures or as the full height of the structure for one-story structures;

L = half the larger dimension of the base of the structure;

v_{so} = half the smaller dimension of the base of the structure;

v_s = the average effective shear wave velocity over a depth of B below the base of the structure determined using v_{so} and Table 19.3-1 or a site-specific study;

v_{so} = the average low strain shear wave velocity over a depth of B below the base of the structure;

G = effective shear modulus derived or approximated based on G_0 and Table 19.3-2;

$G_0 = \gamma v_{so}^2 / g$, the average shear modulus for the soils beneath the foundation at small strain levels;

γ = the average unit weight of the soils over a depth of B below the base of the structure; and

ν = Poisson's ratio; it is permitted to use 0.3 for sandy and 0.45 for clayey soils.

Table 19.3-2 Effective Shear Modulus Ratio (G/G_0)

Site Class	Effective Peak Acceleration, $S_{DS}/2.5^a$			
	$S_{DS}/2.5 = 0$	$S_{DS}/2.5=0.1$	$S_{DS}/2.5 = 0.4$	$S_{DS}/2.5 \geq 0.8$
A	1.00	1.00	1.00	1.00
B	1.00	1.00	0.95	0.90
BC	1.00	0.97	0.84	0.73
C	1.00	0.95	0.75	0.60
CD	1.00	0.92	0.62	0.25
D	1.00	0.90	0.50	0.10
DE	1.00	0.73	0.16	0.03
E	1.00	0.60	0.05	<i>b</i>
F	<i>b</i>	<i>b</i>	<i>b</i>	<i>b</i>

^aUse straight-line interpolation for intermediate values of $S_{DS}/2.5$.

^bSite-specific geotechnical investigation and dynamic site response analyses shall be performed.

19.3.4 Radiation Damping for Circular Foundations

The effects of radiation damping for structures with a circular foundation plan shall be represented by the effective damping ratio of the soil–structure system, β_{rd} , determined in accordance with Eq. (19.3-15):

$$\beta_{rd} = \frac{1}{(\tilde{T}/T_r)^2} \beta_r + \frac{1}{(\tilde{T}/T_{rr})^2} \beta_{rr} \quad (19.3-15)$$

$$T_r = 2\pi \sqrt{\frac{M^*}{K_r}} \quad (19.3-16)$$

$$T_{rr} = 2\pi \sqrt{\frac{M^* (h^*)^2}{\alpha_{rr} K_{rr}}} \quad (19.3-17)$$

$$K_r = \frac{8Gr_f}{2-\nu} \quad (19.3-18)$$

$$K_{rr} = \frac{8Gr_f^3}{3(1-\nu)} \quad (19.3-19)$$

$$\beta_r = \left[\frac{\pi}{(K_r / Gr_f)} \right] \left[\frac{a_0}{2} \right] \quad (19.3-20)$$

$$a_0 = \left[\frac{2\pi r_f}{\tilde{T} \nu_s} \right] \quad (19.3-21)$$

$$\beta_{rr} = \left[\frac{(\pi \psi / 4) a_0^2}{(K_{rr} / Gr_f^3) [2 + a_0^2]} \right] \left[\frac{a_0}{2\alpha_{rr}} \right] \quad (19.3-22)$$

$$\psi = \sqrt{\frac{2(1-\nu)}{1-2\nu}} \leq 2.5 \quad (19.3-23)$$

$$\alpha_{rr} = 1.0 - \left[\frac{0.35a_0^2}{1.0 + a_0^2} \right] \quad (19.3-24)$$

where

r_f = radius of the circular foundation;

v_s = the average effective shear wave velocity over a depth of r_f below the base of the structure determined using v_{so} and Table 19.3-1 or a site-specific study;

v_{so} = the average low strain shear wave velocity over a depth of r_f below the base of the structure; and

γ = the average unit weight of the soils over a depth of r_f below the base of the structure.

19.3.5 Soil Damping

The effects of soil hysteretic damping shall be represented by the effective soil hysteretic damping ratio, β_s , determined based on a site-specific study. Alternatively, it is permitted to determine β_s in accordance with Table 19.3-3.

Table 19.3-3 Soil Hysteretic Damping Ratio, β_s

Site Class	Effective Peak Acceleration, $S_{DS} / 2.5^a$			
	$S_{DS}/2.5 = 0$	$S_{DS}/2.5=0.1$	$S_{DS}/2.5 = 0.4$	$S_{DS}/2.5 \geq 0.8$
C	0.01	0.01	0.03	0.05
CD	0.01	0.01	0.05	0.09
D	0.01	0.02	0.07	0.15
DE	0.01	0.03	0.12	0.20
E	0.01	0.05	0.20	<i>b</i>
F	<i>b</i>	<i>b</i>	<i>b</i>	<i>b</i>

^aUse straight-line interpolation for intermediate values of $S_{DS}/2.5$.

^bSite-specific geotechnical investigation and dynamic site response analyses shall be performed.

Page intentionally left blank.

CHAPTER 20, SITE CLASSIFICATION PROCEDURE FOR SEISMIC DESIGN

(Modifications)

SECTION 20.1 SITE CLASSIFICATION

Replace Section 20.1 with the following:

The site soil shall be classified in accordance with Table 20.2-1 and Section 20.2 based on the average shear wave velocity parameter \bar{v}_s , which is derived from the measured shear wave velocity profile from the ground surface to a depth of 100 ft (30 m). Where shear wave velocity is not measured, appropriate generalized correlations between shear wave velocity and standard penetration test (SPT) blow counts, Cone Penetration Test (CPT) tip resistance, shear strength, or other geotechnical parameters shall be used to obtain an estimated shear wave velocity profile as described in Section 20.3. Where site-specific data (measured shear wave velocities or other geotechnical data that can be used to estimate shear wave velocity) are available only to a maximum depth less than 100 ft (30 m), \bar{v}_s shall be estimated as described in Section 20.3. Where the soil properties are not known in sufficient detail to determine the site class, the most critical site conditions of Site Class C, Site Class CD and Site Class D, as defined in Section 11.4.2, shall be used unless the Authority Having Jurisdiction or geotechnical data determine that Site Class DE, E or F soils are present at the site. Site Classes A and B shall not be assigned to a site if there is more than 10 ft (3.1 m) of soil between the rock surface and the bottom of the spread footing or mat foundation.

SECTION 20.2 SITE CLASS DEFINITIONS

Replace Section 20.2 with the following:

Site class types shall be assigned in accordance with the definitions provided in Table 20.2-1 and this section.

Table 20.2-1 Site classification

Site Class	\bar{v}_s Calculated Using Measured or Estimated Shear Wave Velocity Profile
A. Hard rock	> 5,000 ft/s
B. Medium hard rock	> 3,000 to 5,000 ft/s
BC. Soft rock	>2,100 to 3,000 ft/s
C. Very dense sand or hard clay	>1,450 to 2,100 ft/s
CD. Dense sand or very stiff clay	>1,000 to 1,450 ft/s
D. Medium dense sand or stiff clay	>700 to 1,000 ft/s
DE. Loose sand or medium stiff clay	>500 to 700 ft/s
E. Very loose sand or soft clay	< 500 ft/s
F. Soils requiring site response analysis in accordance with Section 21.1	See Section 20.2.1

Note: For SI: 1 ft = 0.3048 m ; 1 ft/s = 0.3048 m/s

20.2.1 Site Class F

Where any of the following conditions is satisfied, the site shall be classified as Site Class F and a site response analysis in accordance with Section 21.1 shall be performed.

1. Soil profile includes soils vulnerable to potential failure or collapse under seismic loading, such as liquefiable soils, quick and highly sensitive clays, and collapsible weakly cemented soils.

EXCEPTION: For structures that have fundamental periods of vibration equal to or less than 0.5 s, site response analysis is not required to determine spectral accelerations for liquefiable soils. Rather, a site class is permitted to be determined in accordance with Section 20.2.

2. Soil profile includes peats and/or highly organic clays [$H > 10$ ft ($H > 3$ m)] where H = thickness of soil.
3. Soil profile includes very high plasticity clays [$H > 25$ ft ($H > 7.6$ m)] with $PI > 75$ in a soil profile that would otherwise be classified as Site Class CD, D, DE or E.

EXCEPTION: Site response analysis is not required for this clay category for Seismic Design Category A and Seismic Design Category B, where Seismic Design Category is based on the values S_{DS} and S_{DI} .

4. Soil profile includes soft/medium stiff clays [$H > 120$ ft ($H > 37$ m)] with $s_u < 1,000$ psf ($s_u < 50$ kPa).

EXCEPTION: Site response analysis is not required for this clay category for Seismic Design Category A and Seismic Design Category B.

20.2.2 Site Class E (Soft Clay)

Where a site does not qualify under the criteria for Site Class F and there is a total thickness of soft clay greater than 10 ft (3 m) where a soft clay layer is defined by $s_u < 500$ psf ($s_u < 25$ kPa), $w \geq 40\%$, and $PI > 20$, it shall be classified as Site Class E. This classification is made regardless of \bar{v}_s , as computed in Section 20.4.

20.2.3 Site Classes C, CD, D, DE and E

The assignment of Site Class C, CD, D, DE shall be made based on the average shear wave velocity \bar{v}_s , which is derived from the site shear wave velocity profile from the ground surface to a depth of 100 ft (30 m), as described in Section 20.4.

20.2.4 Site Class B and BC (Medium Hard and Soft Rock)

Site Class B can only be assigned to a site on the basis of shear wave velocity measured on site.

If shear wave velocity data are not available and the site condition is estimated by a geotechnical engineer, engineering geologist, or seismologist as Site Class B or BC on the basis of site geology consisting of competent rock with moderate fracturing and weathering, the site shall be classified as Site Class BC. Softer and more highly fractured and weathered rock shall either be measured on site for shear wave velocity or classified as Site Class C.

20.2.5 Site Class A (Hard Rock)

The hard rock, Site Class A category shall be supported by shear wave velocity measurement either on site or on profiles of the same rock type in the same formation with an equal or greater degree of weathering

and fracturing. Where hard rock conditions are known to be continuous to a depth of 100 ft (30 m), surficial shear wave velocity measurements to maximum depths less than 100 ft are permitted to be extrapolated to assess \bar{v}_s .

SECTION 20.3 ESTIMATION OF SHEAR WAVE VELOCITY PROFILES

Replace Section 20.3 with the following:

Where measured shear wave velocity data are not available, shear wave velocity shall be estimated as a function of depth using correlations with suitable geotechnical parameters, including standard penetration test (SPT) blow counts, shear strength, overburden pressure, void ratio, or cone penetration test (CPT) tip resistance, measured at the site.

Due to the uncertainty inherent in such correlations, site class based on estimated values of \bar{v}_s shall be derived using \bar{v}_s , $\bar{v}_s/1.3$, and $1.3\bar{v}_s$ when correlation models are used to derive shear wave velocities. Where correlations derived for specific local regions can be demonstrated to have greater accuracy, factors less than 1.3 can be used if approved by local building officials. If the different average velocities result in different site classes per Table 20.2-1, the most critical of the site classes for ground motion analysis at each period shall be determined by a geotechnical engineer, as described in Section 11.4.2.

Where the available data used to establish the shear wave velocity profile extends to depths less than 100 ft (30 m) but more than 50 ft (15 m), and the site geology is such that soft layers are unlikely to be encountered below the maximum profile depth, the shear wave velocity of the last layer in the profile shall be extended to 100 ft for the calculation of \bar{v}_s in Eq. (20.4-1). Where the data does not extend to depths of 50 ft (15 m), default site classes as described in Section 20.1 shall be used unless another site class can be justified on the basis of the site geology.

SECTION 20.4 DEFINITIONS OF SITE CLASS PARAMETERS

Replace Section 20.4 with the following:

The definitions presented in this section shall apply to the upper 100 ft (30 m) of the site profile. Profiles containing distinct soil and rock layers shall be subdivided into those layers designated by a number that ranges from 1 to n at the bottom where there is a total of n distinct layers in the upper 100 ft (30 m). The symbol i refers to any one of the layers between 1 and n .

20.4.1 \bar{v}_s , AVERAGE SHEAR WAVE VELOCITY.

$$\bar{v}_s = \frac{\sum_{i=1}^n d_i}{\sum_{i=1}^n \frac{d_i}{v_{si}}} \quad (20.4-1)$$

where

d_i = the thickness of any layer between 0 and 100 ft (30 m);

v_{si} = the shear wave velocity in ft/s (m/s); and

$\sum_{i=1}^n d_i = 100$ ft (30 m).

Page intentionally left blank.

CHAPTER 21, SITE SPECIFIC GROUND MOTION PROCEDURES FOR SEISMIC DESIGN

(Modifications)

SECTION 21.1 SITE RESPONSE ANALYSIS

Replace Section 21.1 with the following:

The requirements of Section 21.1 shall be satisfied where site response analysis is performed or required by Section 11.4.7. The analysis shall be documented in a report.

21.1.1 Base Ground Motions

An MCE_R response spectrum shall be developed for a base condition consisting of bedrock, or when bedrock is very deep, firm soil conditions below softer surficial layers, using the procedure of Sections 11.4.6 or 21.2. Unless a site-specific ground motion hazard analysis described in Section 21.2 is carried out, the MCE_R base response spectrum shall be developed using the procedure of Section 11.4.6, assuming a site condition representative of the geological conditions at the base (represented by a base-condition average shear wave velocity, v_{s30}). At least five recorded or simulated horizontal ground motion acceleration time histories shall be selected from events that have magnitudes and fault distances that are consistent with those that control the MCE_R ground motion. Each selected time history shall be scaled so that its response spectrum is, on average, approximately at the level of the MCE_R rock response spectrum over the period range of significance to structural response.

21.1.2 Site Condition Modeling

A site response model based on low strain shear wave velocities, nonlinear or equivalent linear shear stress–strain relationships, and unit weights shall be developed. Low strain shear wave velocities shall be determined from field measurements at the site or from measurements from similar soils in the site vicinity. Nonlinear or equivalent linear shear stress–strain relationships and unit weights shall be selected on the basis of laboratory tests or published relationships for similar soils. The uncertainties in soil properties shall be estimated. Where very deep soil profiles make the development of a soil model to bedrock impractical, the model is permitted to be terminated where the soil stiffness is at least as great as the values used to define Site Class C in Chapter 20.

21.1.3 Site Response Analysis and Computed Results

Base ground motion time histories shall be input to the soil profile as outcropping motions. Using appropriate computational techniques that treat nonlinear soil properties in a nonlinear or equivalent-linear manner, the response of the soil profile shall be determined and surface ground motion time histories shall be calculated. Ratios of 5% damped response spectra of surface ground motions to input base ground motions shall be calculated. The recommended surface MCE_R ground motion response spectrum shall not be lower than the MCE_R response spectrum of the base motion multiplied by the average surface-to-base response spectral ratios (calculated period by period) obtained from the site response analyses. The recommended surface ground motions that result from the analysis shall reflect consideration of sensitivity of response to uncertainty in soil properties, depth of soil model, and input motions.

SECTION 21.2 RISK-TARGETED MAXIMUM CONSIDERED EARTHQUAKE (MCE_R) GROUND MOTION HAZARD ANALYSIS

Replace Section 21.2 with the following:

The requirements of Section 21.2 shall be satisfied where a ground motion hazard analysis is performed or required by Section 11.4.7. The ground motion hazard analysis shall account for the regional tectonic setting, geology, and seismicity; the expected recurrence rates and maximum magnitudes of earthquakes on known faults and source zones; the characteristics of ground motion near source effects, if any, on ground motions; and the effects of subsurface site conditions on ground motions. The characteristics of subsurface site conditions shall be considered either using ground motion models that represent regional and local geology or in accordance with Section 21.1. The analysis shall incorporate current seismic interpretations, including uncertainties for models and parameter values for seismic sources and ground motions. If the spectral response accelerations predicted by the ground motion models do not represent the maximum response in the horizontal plane, then the response spectral accelerations computed from the hazard analysis shall be scaled by factors to increase the motions to the maximum response. If the ground motion models predict the geometric mean or similar metric of the two horizontal components, then the scale factors shall be 1.2 for periods less than or equal to 0.2 s, 1.25 for a period of 1.0 s, and 1.3 for periods greater than or equal to 10 s, unless it can be shown that other scale factors more closely represent the maximum response, in the horizontal plane, to the geometric mean of the horizontal components. Scale factors between these periods shall be obtained by linear interpolation. The analysis shall be documented in a report.

21.2.1 Probabilistic (MCE_R) Ground Motions

The probabilistic spectral response accelerations shall be taken as the spectral response accelerations in the direction of maximum horizontal response represented by a 5% damped acceleration response spectrum that is expected to achieve a 1% probability of collapse within a 50-year period.

At each spectral response period for which the acceleration is computed, ordinates of the probabilistic ground motion response spectrum shall be determined from iterative integration of a site-specific hazard curve with a lognormal probability density function representing the collapse fragility (i.e., probability of collapse as a function of spectral response acceleration). The ordinate of the probabilistic ground motion response spectrum at each period shall achieve a 1% probability of collapse within a 50-year period for a collapse fragility that has (1) a 10% probability of collapse at said ordinate of the probabilistic ground motion response spectrum and (2) a logarithmic standard deviation value of 0.6.

21.2.2 Deterministic (MCE_R) Ground Motions

The deterministic spectral response acceleration at each period shall be calculated as an 84th-percentile 5% damped spectral response acceleration in the direction of maximum horizontal response computed at that period. The largest such acceleration calculated for scenario earthquakes on all known faults within the region shall be used. The scenario earthquakes shall be determined from deaggregation for the probabilistic spectral response acceleration at each period. Scenario earthquakes contributing less than 10% of the largest contributor at each period shall be ignored.

For the purpose of this standard, the deterministic response spectral acceleration at each period shall be taken as not less than the deterministic lower limit response spectrum of Table 21.2-1 of the site class determined in accordance with the site class requirements of Section 11.4.2.

EXCEPTION: The deterministic ground motion response spectrum need not be calculated where the probabilistic ground motion response spectrum of 21.2.1 is, at all response periods, less than the deterministic lower limit response spectrum of Table 21.2-1 for the site class determined in accordance with the site class requirements of Section 11.4.2.

Table 21.2-1 Deterministic Lower Limit Values of MCE_R Response Spectra and PGA_G (g)

Period T (s)	Site Class							
	A	B	BC	C	CD	D	DE	E
0.00	0.50	0.57	0.66	0.73	0.74	0.69	0.61	0.55
0.01	0.50	0.57	0.66	0.73	0.75	0.70	0.62	0.55
0.02	0.52	0.58	0.68	0.74	0.75	0.70	0.62	0.55
0.03	0.60	0.66	0.75	0.79	0.78	0.70	0.62	0.55
0.05	0.81	0.89	0.95	0.96	0.89	0.76	0.62	0.55
0.075	1.04	1.14	1.21	1.19	1.08	0.90	0.71	0.62
0.10	1.12	1.25	1.37	1.37	1.24	1.04	0.82	0.72
0.15	1.12	1.29	1.53	1.61	1.50	1.27	1.00	0.87
0.20	1.01	1.19	1.50	1.71	1.66	1.44	1.15	1.01
0.25	0.90	1.07	1.40	1.71	1.77	1.58	1.30	1.15
0.30	0.81	0.98	1.30	1.66	1.83	1.71	1.44	1.30
0.40	0.69	0.83	1.14	1.53	1.82	1.80	1.61	1.48
0.50	0.60	0.72	1.01	1.38	1.73	1.80	1.68	1.60
0.75	0.46	0.54	0.76	1.07	1.41	1.57	1.60	1.59
1.0	0.37	0.42	0.60	0.86	1.17	1.39	1.51	1.58
1.5	0.26	0.29	0.41	0.60	0.84	1.09	1.35	1.54
2.0	0.21	0.23	0.31	0.45	0.64	0.88	1.19	1.46
3.0	0.15	0.17	0.21	0.31	0.45	0.63	0.89	1.11
4.0	0.12	0.13	0.16	0.24	0.34	0.47	0.66	0.81
5.0	0.10	0.11	0.13	0.19	0.26	0.36	0.49	0.61
7.5	0.063	0.068	0.080	0.11	0.15	0.19	0.26	0.31
10	0.042	0.045	0.052	0.069	0.089	0.11	0.14	0.17
PGA_G	0.37	0.43	0.50	0.55	0.56	0.53	0.46	0.42

21.2.3 Site-Specific MCE_R Response Spectrum

The site-specific MCE_R spectral response acceleration at any period, S_{aM} , shall be taken as the lesser of the spectral response accelerations from the probabilistic ground motions of Section 21.2.1 and the deterministic ground motions of Section 21.2.2.

EXCEPTION: The site-specific MCE_R response spectrum may be taken as equal to the MCE_R response spectrum obtained from the USGS Seismic Design Geodatabase where values of the MCE_R response spectrum are provided by the USGS Seismic Design Web Service for the site class determined in accordance with Section 11.4.2.

The site-specific MCE_R spectral response acceleration at any period shall not be taken as less than 80% of the MCE_R response spectrum obtained from the USGS Seismic Design Geodatabase <https://doi.org/10.5066/F7NK3C76> where values of the MCE_R response spectrum are provided by the USGS Seismic Design Web Service for the site class determined in accordance with Section 11.4.2.

For sites classified as Site Class F requiring site-specific analysis in accordance with Section 11.4.7, the site-specific MCE_R spectral response acceleration at any period shall not be less than 80% of the MCE_R response spectrum obtained from the USGS Seismic Design Geodatabase <https://doi.org/10.5066/F7NK3C76> where values of the MCE_R response spectrum are provided by the USGS Seismic Design Web Service for Site Class E.

EXCEPTION: Where a different site class can be justified using the site-specific classification procedures of Section 20.3.3, a lower limit of 80% of S_{aM} for the justified site class shall be permitted to be used.

SECTION 21.3 DESIGN RESPONSE SPECTRUM

Replace Section 21.3 with the following:

The design spectral response acceleration at any period shall be determined from Eq. (21.3-1):

$$S_a = \frac{2}{3} S_{aM} \quad (21.3-1)$$

where S_{aM} is the MCE_R spectral response acceleration obtained from Section 21.1 or 21.2.

SECTION 21.4 DESIGN ACCELERATION PARAMETERS

Replace Section 21.4 with the following:

Where the site-specific procedure is used to determine the design ground motion in accordance with Section 21.3, the parameter S_{DS} shall be taken as 90% of the maximum spectral acceleration, S_a , obtained from the site-specific spectrum, at any period within the range from 0.2 to 5 s, inclusive. The parameter S_{DI} shall be taken as 90% of the maximum value of the product, $T \cdot S_a$, for periods from 1 to 2 s for sites with $\bar{v}_s > 1,450$ ft/s ($\bar{v}_s > 442$ m/s) and for periods from 1 to 5 s for sites with $\bar{v}_s \leq 1,450$ ft/s ($\bar{v}_s \leq 442$ m/s), but not less than 100% of the values of S_a at 1 s. The parameters S_{MS} and S_{MI} shall be taken as 1.5 times S_{DS} and S_{DI} , respectively.

For use with the equivalent lateral force procedure, the site-specific spectral acceleration, S_a at T shall be permitted to replace S_{D1}/T in Eq. (12.8-3) and $S_{D1}T_L/T^2$ in Eq. (12.8-4). The parameter S_{DS} calculated per this section shall be permitted to be used in Eqs. (12.8-2), (12.8-5), (15.4-1), and (15.4-3). The mapped value of S_I shall be used in Eqs. (12.8-6), (15.4-2), and (15.4-4).

SECTION 21.5 MAXIMUM CONSIDERED EARTHQUAKE GEOMETRIC MEAN (MCE_G) PEAK GROUND ACCELERATION

Replace Section 21.5 with the following:

21.5.1 Probabilistic MCE_G Peak Ground Acceleration.

The probabilistic geometric mean peak ground acceleration shall be taken as the geometric mean peak ground acceleration with a 2% probability of exceedance within a 50-year period.

21.5.2 Deterministic MCE_G Peak Ground Acceleration.

The deterministic geometric mean peak ground acceleration shall be calculated as the largest 84th-percentile geometric mean peak ground acceleration for scenario earthquakes on all known active faults within the site region. The scenario earthquakes shall be determined from deaggregation for the probabilistic spectral response acceleration at each period. Scenario earthquakes contributing less than 10% of the largest contributor at each period shall be ignored. The deterministic geometric mean peak ground acceleration shall not be taken as lower than the value of PGA_G of Table 21.2-1 of the site class determined in accordance with the site class requirements of Section 11.4.2.

21.5.3 Site-Specific MCE_G Peak Ground Acceleration PGA_M

The site-specific MCE_G peak ground acceleration, PGA_M , shall be taken as the lesser of the probabilistic geometric mean peak ground acceleration of Section 21.5.1 and the deterministic geometric mean peak ground acceleration of Section 21.5.2. The site-specific MCE_G peak ground acceleration shall not be taken as less than 80% of the value of the MCE_G peak ground acceleration parameter PGA_M obtained from the USGS Seismic Design Geodatabase <https://doi.org/10.5066/F7NK3C76> where the value of PGA_M is provided by the USGS Seismic Design Web Service for the site class determined in accordance with Section 11.4.2.

Page intentionally left blank.

CHAPTER 22, SEISMIC GROUND MOTION AND LONG-PERIOD TRANSITION MAPS

(Modifications)

Revise Chapter 22 as follows

Contained in this chapter are Figs. 22-1 through 22-8, which map the risk-targeted maximum considered earthquake (MCE_R) spectral response acceleration parameters S_{MS} and S_{MI} for the default site class defined in Section 11.4.2.1; Figs. 22-9 through 22-13, which map the maximum considered earthquake geometric mean (MCE_G) peak ground acceleration parameter PGA_M for the default site class; and Figs. 22-14 through 22-17, which map the long-period transition period parameter T_L . In accordance with Section 11.4.3, S_{MS} and S_{MI} values for Site Classes A, B, BC, C, CD, D, DE, and E—as well as values of the MCE_R spectral response acceleration parameters S_S and S_I (for Site Class BC)—are contained in the USGS Seismic Design Geodatabase defined in Section 11.2; values of PGA_M for all of the site classes are also contained in this geodatabase, in accordance with Section 11.8.3. For the definitions of these ground motion parameters, see Section 11.3.

These maps and the USGS Seismic Design Geodatabase were prepared by the U.S. Geological Survey in collaboration with the Building Seismic Safety Council (BSSC) Provisions Update Committee and the American Society of Civil Engineers (ASCE) 7 Seismic Subcommittee, and have been updated for these *Provisions*.

Maps of T_L for Guam and the Northern Mariana Islands and for American Samoa are not provided because this parameter has not been developed for those islands via the same deaggregation computations done for the other U.S. regions. Therefore, as in previous editions of these *Provisions*, the value of T_L shall be 12 s for those islands.

The following is a list of the maps contained in this chapter:

- Figure 22-1 S_{MS} for the Default Site Class, for the Conterminous United States
- Figure 22-2 S_{MI} for the Default Site Class, for the Conterminous United States
- Figure 22-3 S_{MS} for the Default Site Class, for Alaska
- Figure 22-4 S_{MI} for the Default Site Class, for Alaska
- Figure 22-5 S_{MS} and S_{MI} for the Default Site Class, for Hawaii
- Figure 22-6 S_{MS} and S_{MI} for the Default Site Class, for Puerto Rico and the United States Virgin Islands
- Figure 22-7 S_{MS} and S_{MI} for the Default Site Class, for Guam and the Northern Mariana Islands
- Figure 22-8 S_{MS} and S_{MI} for the Default Site Class, for American Samoa
- Figure 22-9 PGA_M for the Default Site Class, for the conterminous United States
- Figure 22-10 PGA_M for the Default Site Class, for Alaska
- Figure 22-11 PGA_M for the Default Site Class, for Hawaii
- Figure 22-12 PGA_M for the Default Site Class, for Puerto Rico and the United States Virgin Islands
- Figure 22-13 PGA_M for the Default Site Class, for Guam and the Northern Mariana Islands and American Samoa
- Figure 22-14 T_L for the Conterminous United States
- Figure 22-15 T_L for Alaska
- Figure 22-16 T_L for Hawaii
- Figure 22-17 T_L for Puerto Rico and the United States Virgin Islands



Figure 22-1 S_{MS} for the Default Site Class, for the Conterminous United States

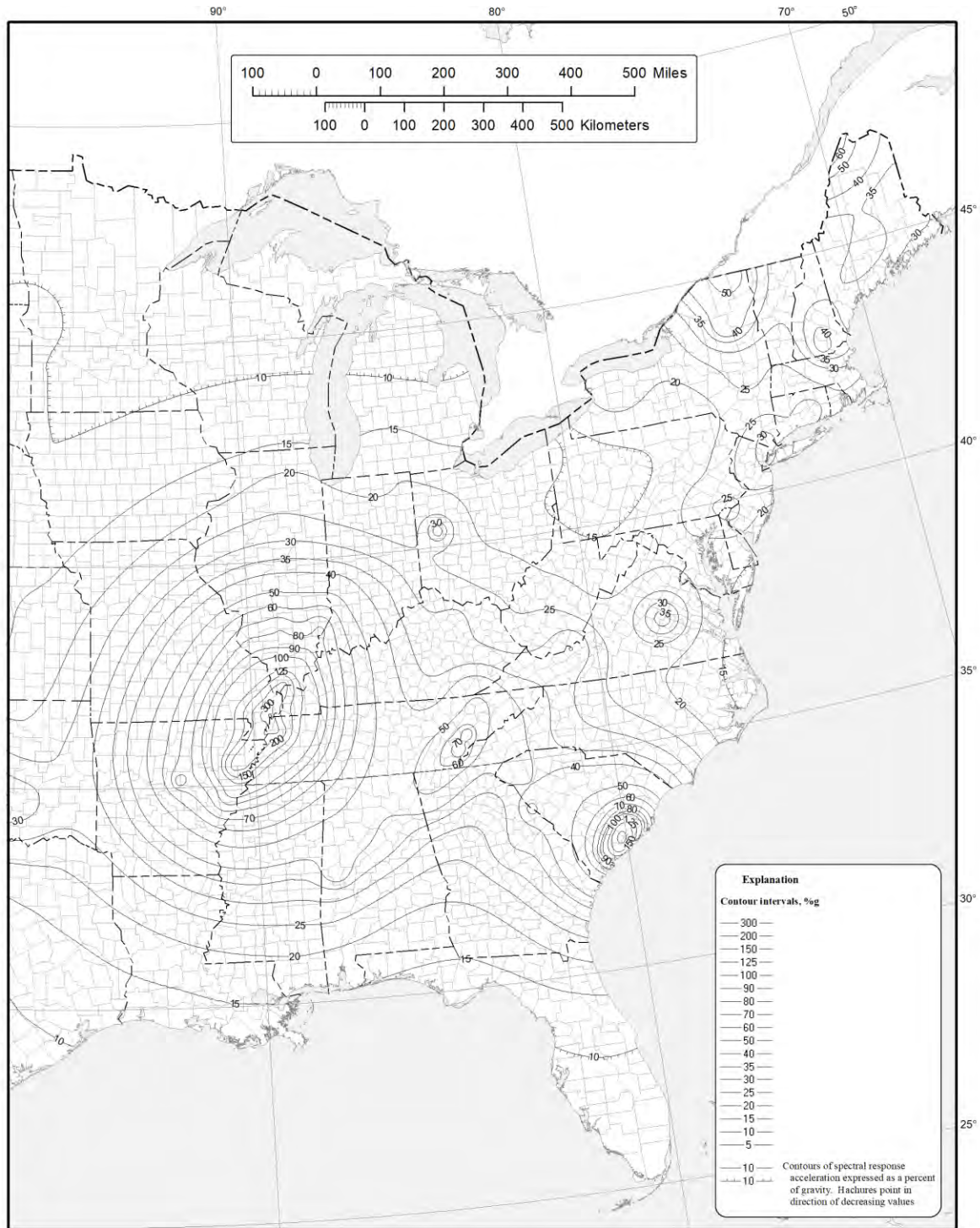

Figure 22-1 (continued) S_{MS} for the Default Site Class, for the Conterminous United States

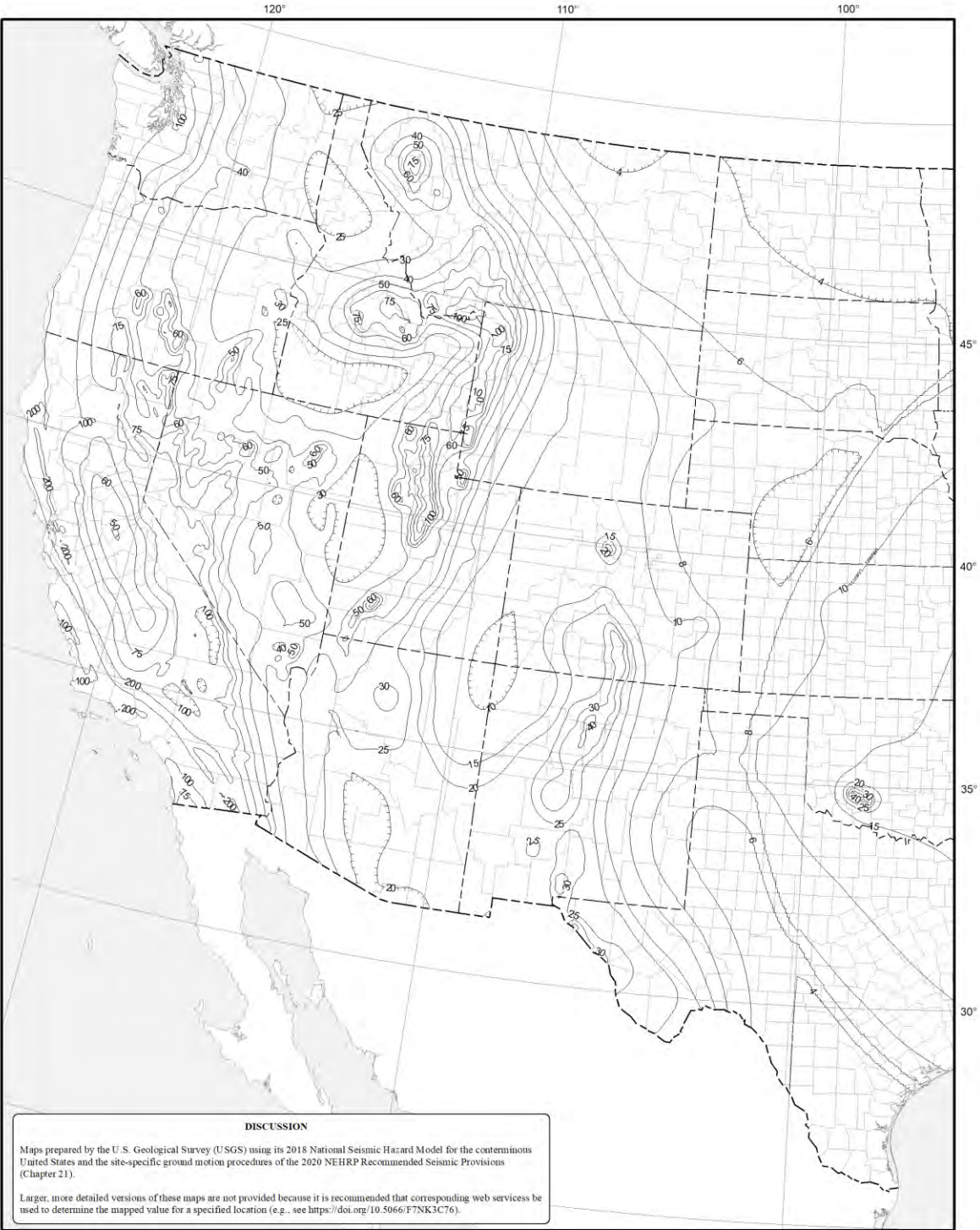

Figure 22-2 S_{MI} for the Default Site Class, for the Conterminous United States



Figure 22-2 (continued) S_{M1} for the Default Site Class, for the Conterminous United States

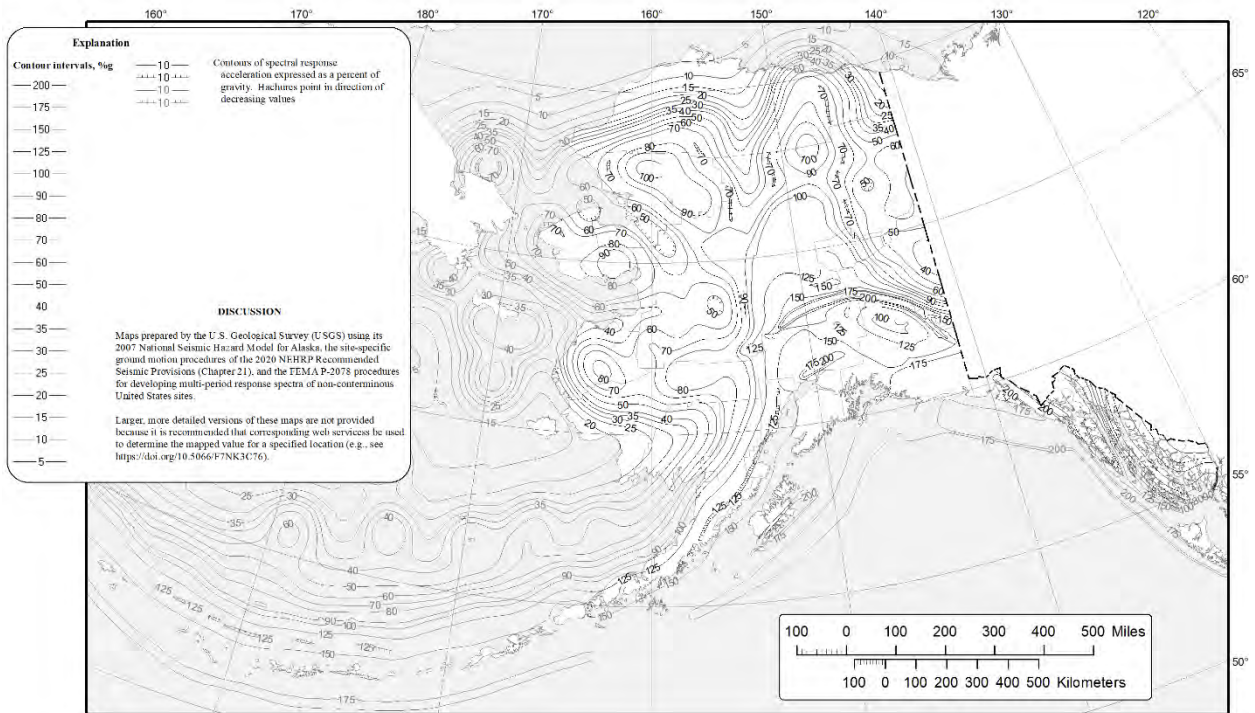

Figure 22-3 S_{MS} for the Default Site Class, for Alaska

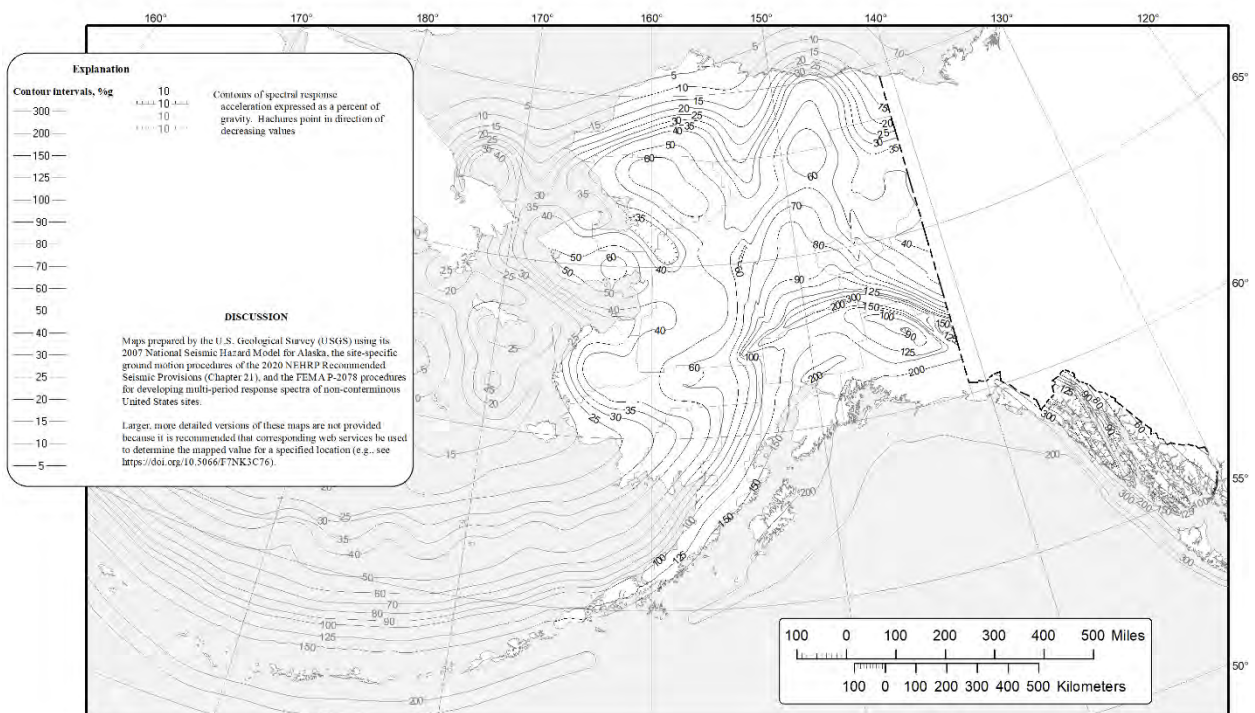
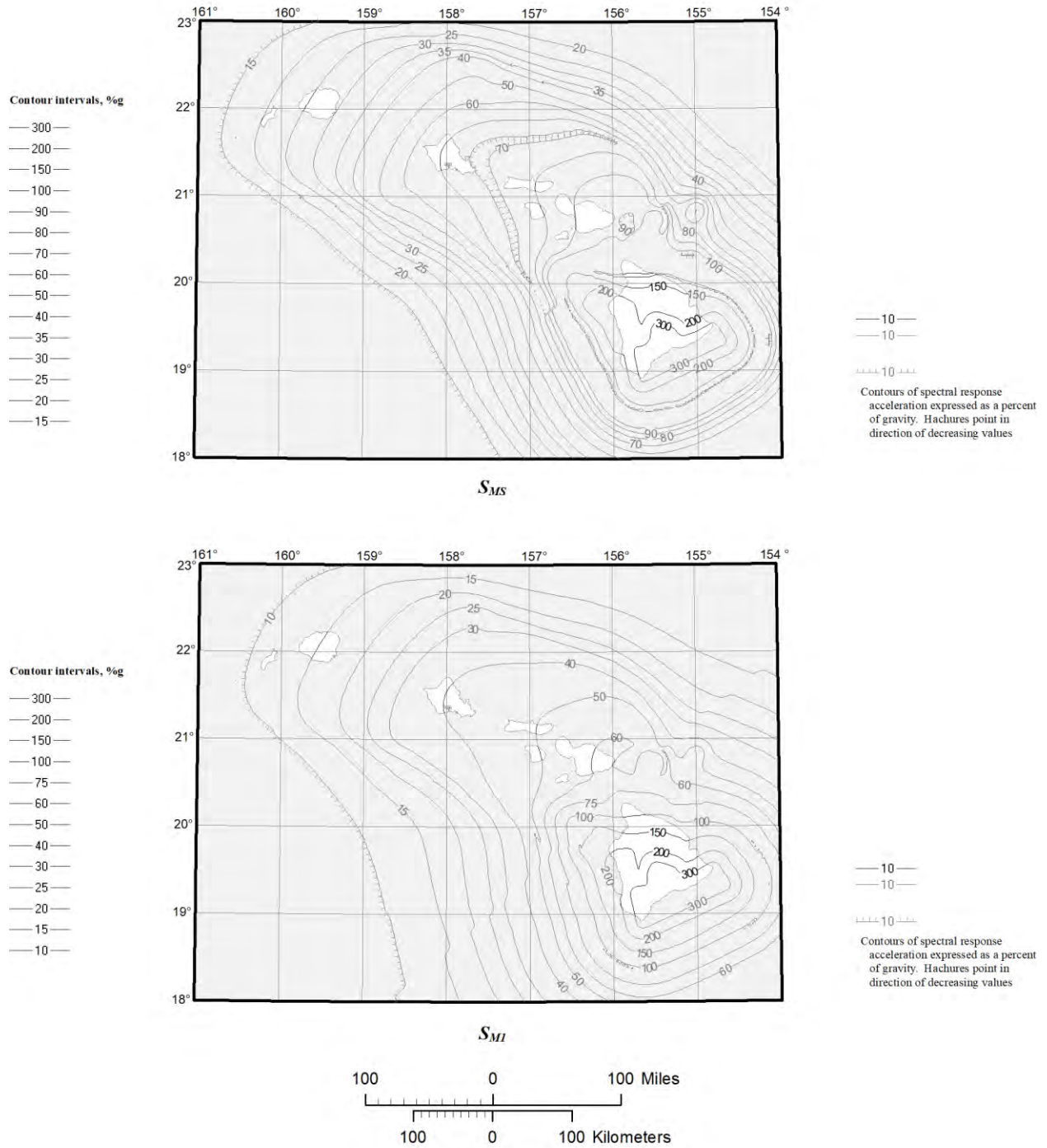

Figure 22-4 S_{MI} for the Default Site Class, for Alaska



DISCUSSION

Maps prepared by the U.S. Geological Survey (USGS) using its 1998 National Seismic Hazard Model for Hawaii, the site-specific ground motion procedures of the 2020 NEHRP Recommended Seismic Provisions (Chapter 21), and the FEMA P-2078 procedures for developing multi-period response spectra of non-continuous United States sites.

Larger, more detailed versions of these maps are not provided because it is recommended that corresponding web services be used to determine the mapped value for a specified location (e.g., see <https://doi.org/10.5066/F7NK3C76>).

Figure 22-5 S_{MS} and S_{MI} for the Default Site Class, for Hawaii

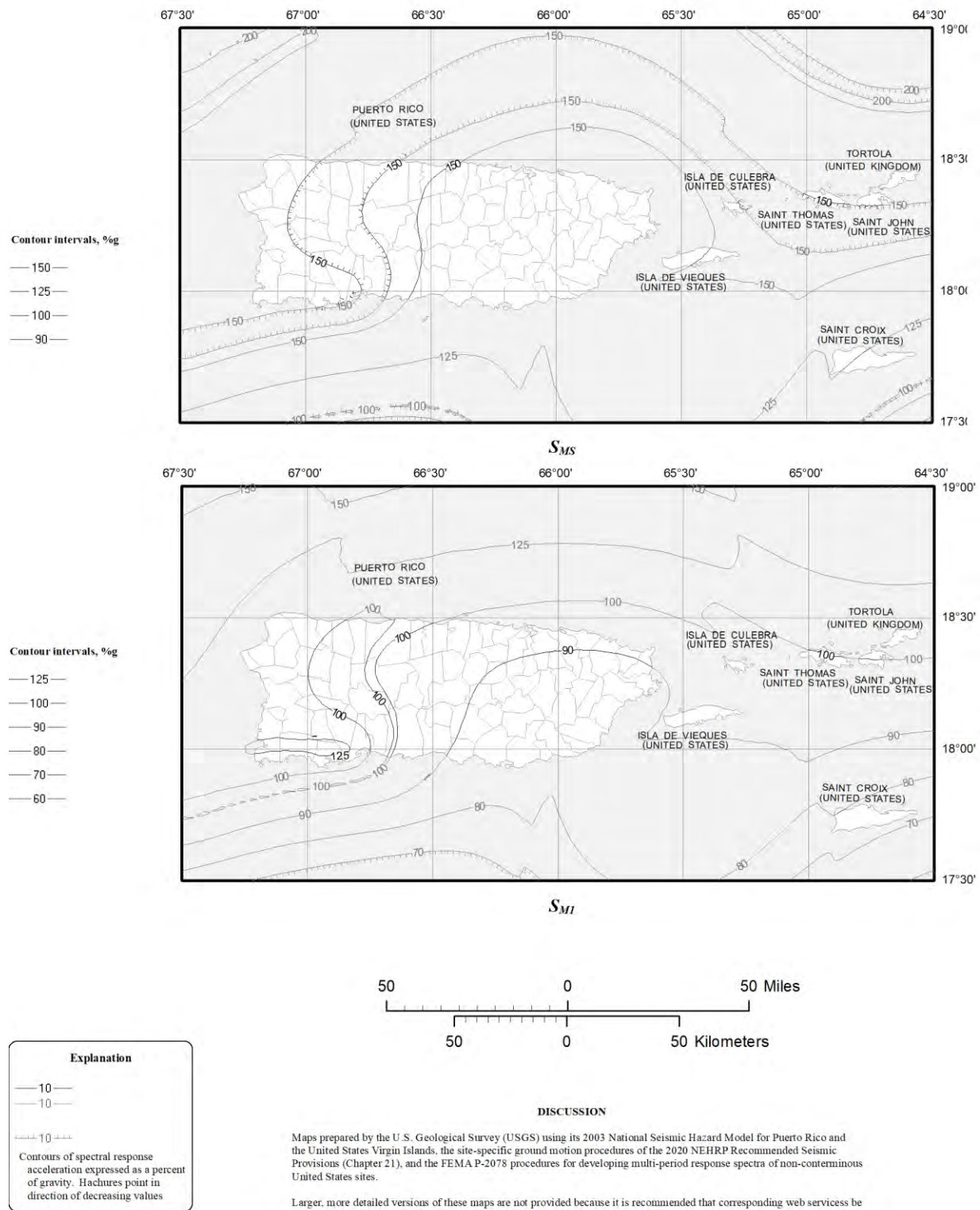
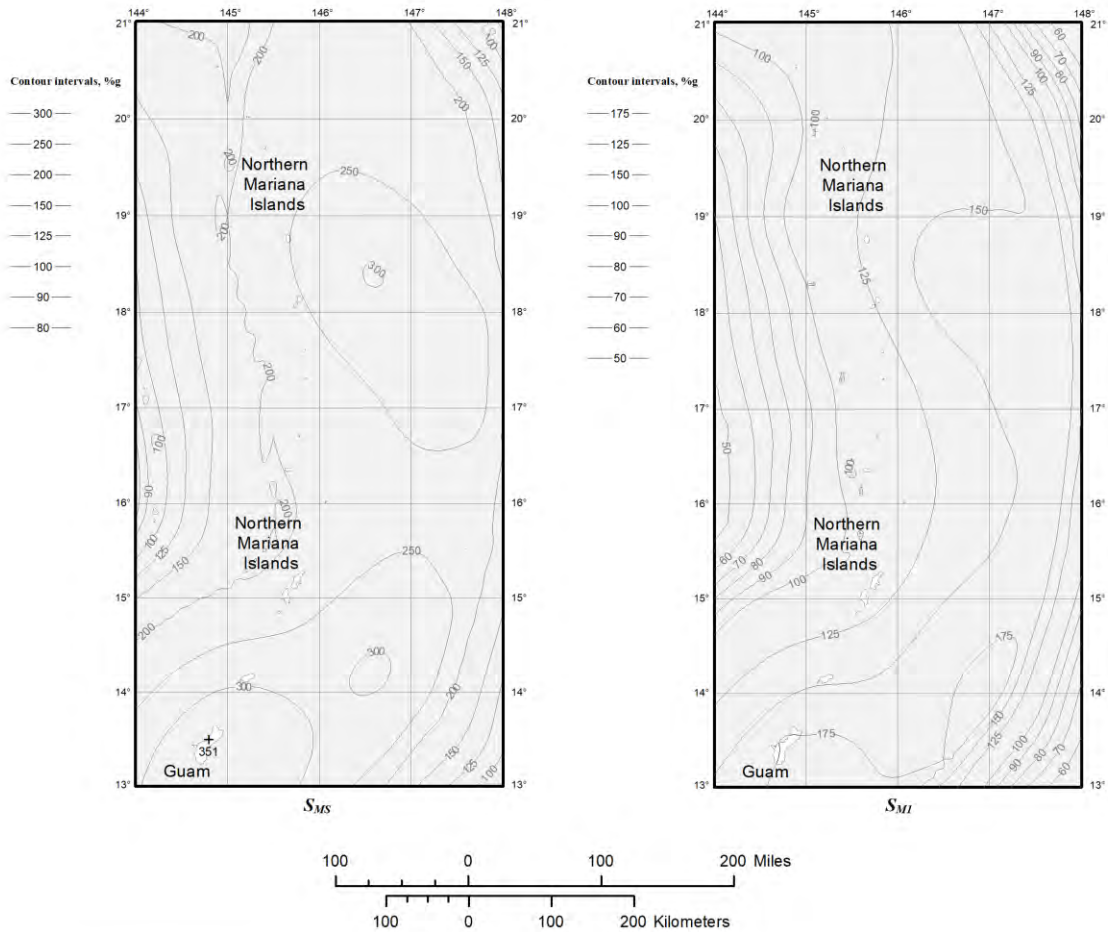

Figure 22-6 S_{MS} and S_{ML} for the Default Site Class, for Puerto Rico and the United States Virgin Islands



Explanation

Contours of spectral response acceleration expressed as a percent of gravity.

— 10 —

— 10 —

DISCUSSION

Maps prepared by the U.S. Geological Survey (USGS) using its 2012 National Seismic Hazard Model for Guam and the Northern Mariana Islands, the site-specific ground motion procedures of the 2020 NEHRP Recommended Seismic Provisions (Chapter 21), and the FEMA P-2078 procedures for developing multi-period response spectra of non-continuous United States sites.

Larger, more detailed versions of these maps are not provided because it is recommended that corresponding web services be used to determine the mapped value for a specified location (e.g., see <https://doi.org/10.5066/F7NK3C76>).

Figure 22-7 S_{MS} and S_{MI} for the Default Site Class, for Guam and the Northern Mariana Islands

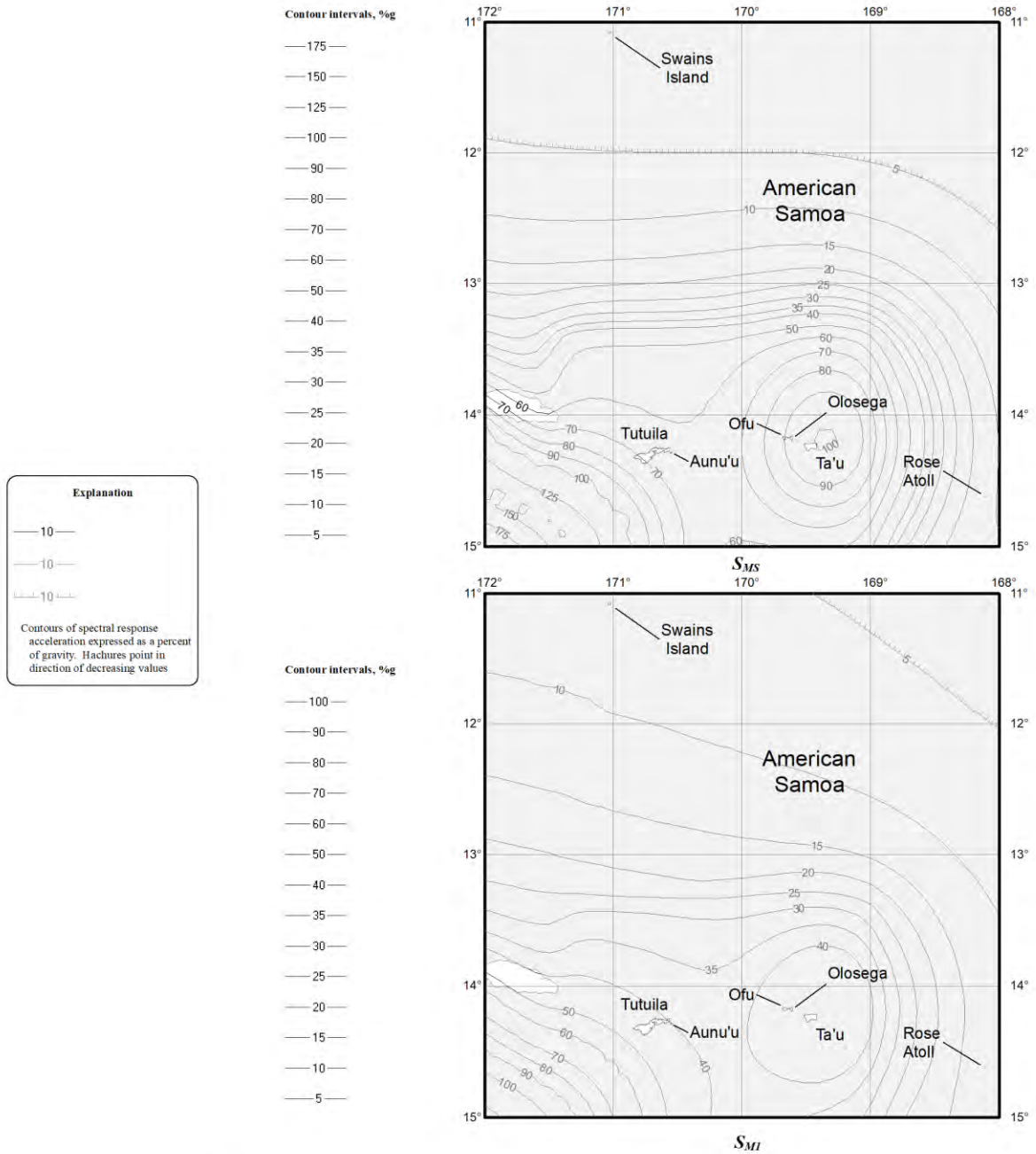

DISCUSSION

Maps prepared by the U.S. Geological Survey (USGS) using its 2012 National Seismic Hazard Model for American Samoa, the site-specific ground motion procedures of the 2020 NEHRP Recommended Seismic Provisions (Chapter 21), and the FEMA P-2078 procedures for developing multi-period response spectra of non-coextensive United States sites.

Larger, more detailed versions of these maps are not provided because it is recommended that corresponding web services be used to determine the mapped value for a specified location (e.g., see <https://doi.org/10.5066/F7NK3C76>).

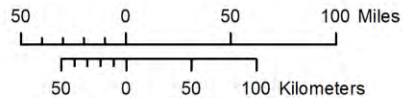

Figure 22-8 S_{MS} and S_{Ml} for the Default Site Class, for American Samoa



Figure 22-9 PGa_M for the Default Site Class, for the conterminous United States



Figure 22-9 (continued) PGA_M for the Default Site Class, for the conterminous United States

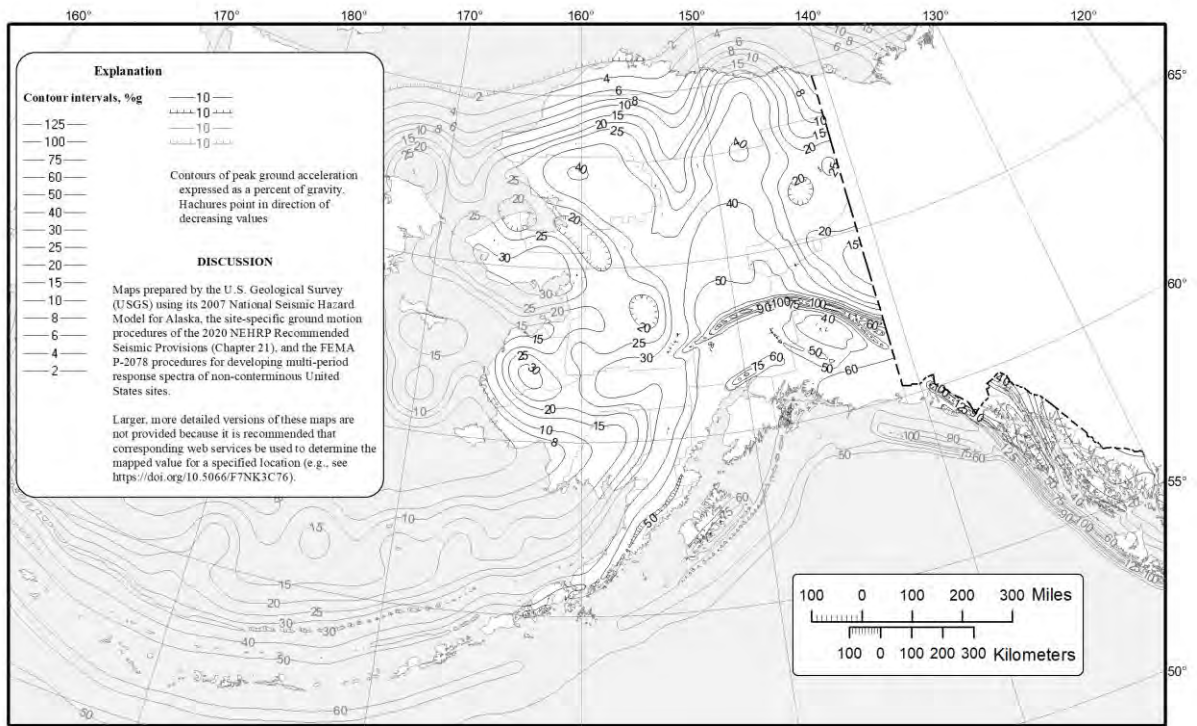

Figure 22-10 PG_{AM} for the Default Site Class, for Alaska

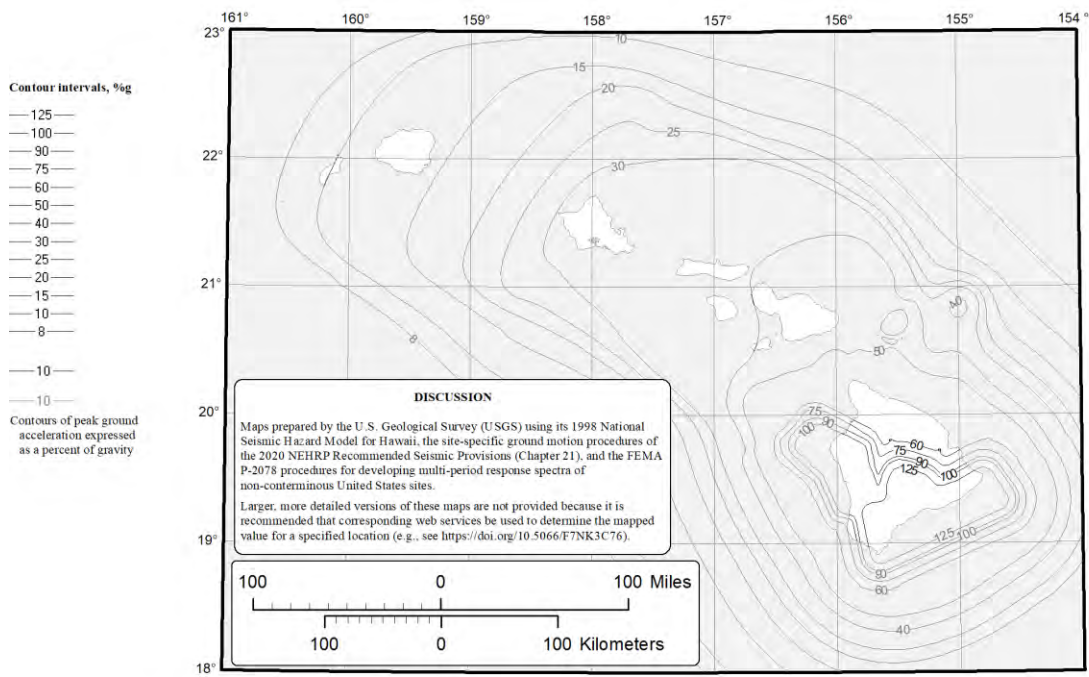
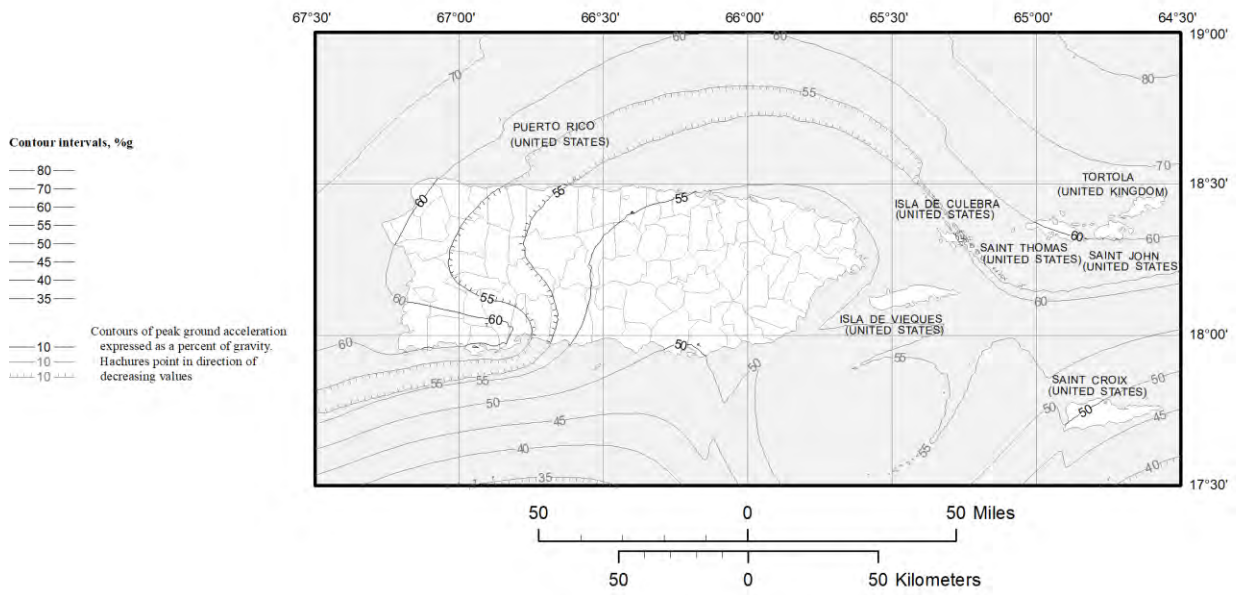

Figure 22-11 PG_{AM} for the Default Site Class, for Hawaii



DISCUSSION

Maps prepared by the U.S. Geological Survey (USGS) using its 2003 National Seismic Hazard Model for Puerto Rico and the United States Virgin Islands, the site-specific ground motion procedures of the 2020 NEHRP Recommended Seismic Provisions (Chapter 21), and the FEMA P-2078 procedures for developing multi-period response spectra of non-continuous United States sites.

Larger, more detailed versions of these maps are not provided because it is recommended that corresponding web services be used to determine the mapped value for a specified location (e.g., see <https://doi.org/10.5066/F7NK3C76>).

Figure 22-12 PGA_M for the Default Site Class, for Puerto Rico and the United States Virgin Islands

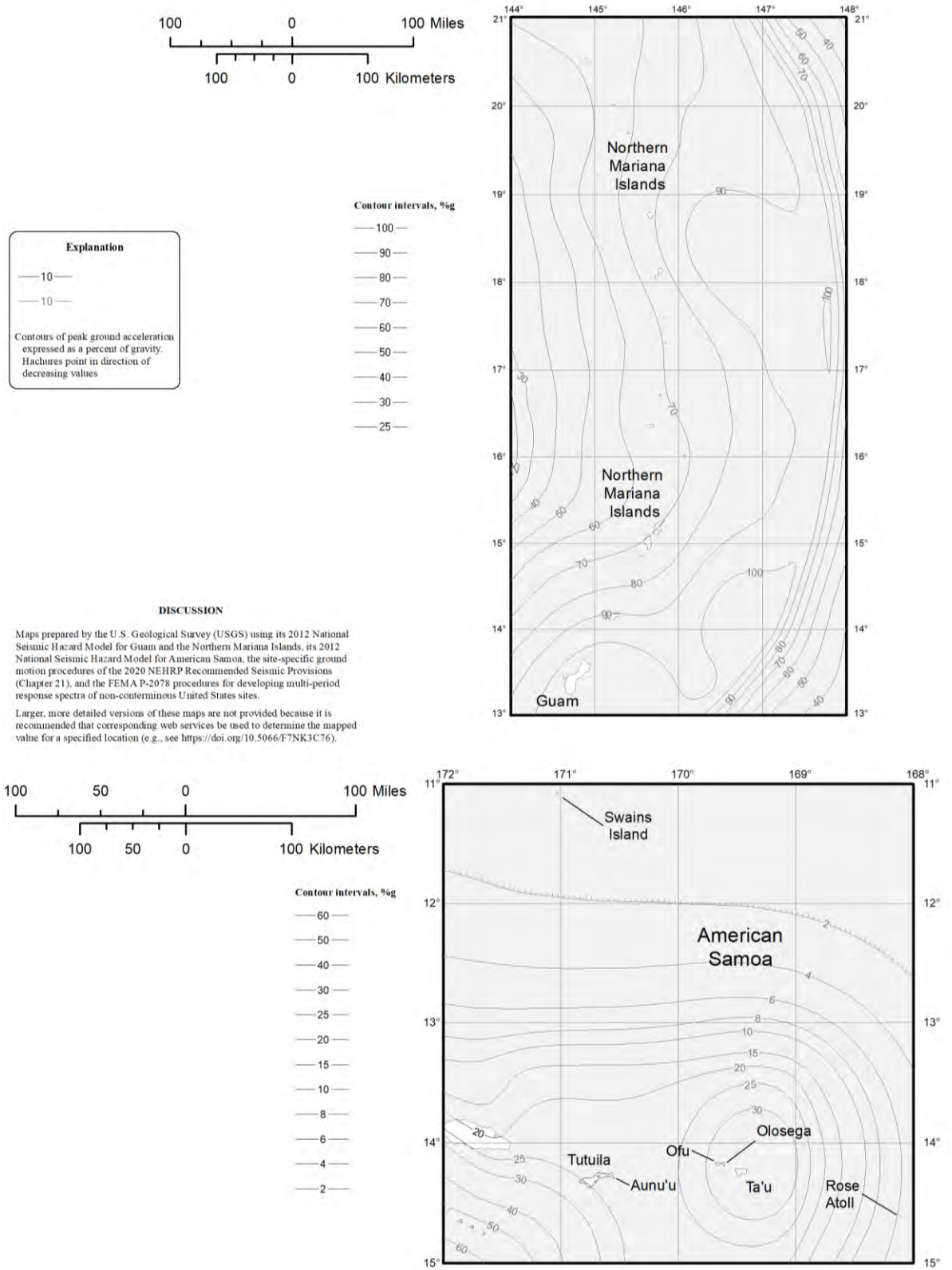

Figure 22-13 PGA_M for the Default Site Class, for Guam and the Northern Mariana Islands and American Samoa

Figure 22-14 T_L for the Conterminous United States

This map has not changed with respect to *ASCE/SEI 7-16*

Figure 22-15 T_L for Alaska

This map has not changed with respect to *ASCE/SEI 7-16*

Figure 22-16 T_L for Hawaii

This map has not changed with respect to *ASCE/SEI 7-16*

Figure 22-17 T_L for Puerto Rico and the United States Virgin Islands

This map has not changed with respect to *ASCE/SEI 7-16*

Page intentionally left blank.

**2020 NEHRP RECOMMENDED SEISMIC PROVISIONS FOR NEW
BUILDINGS AND OTHER STRUCTURES
PART 2, COMMENTARY**

ASCE/SEI 7-16, CHAPTERS C11-C22 WITH MODIFICATIONS

Part 2 Commentary provides a complete commentary for each chapter. It is comprised of the new commentary to each proposed change contained in Part 1 along with the existing ASCE/SEI 7-16 commentary to unchanged sections. Therefore, the Part 2 Commentary is self-contained. Black bars in the columns indicate new commentary matching Part 1 Provisions changes.

COMMENTARY TO CHAPTER 11, SEISMIC DESIGN CRITERIA

C11.1 GENERAL

Many of the technical changes made to the seismic provisions of the 2010 edition of this standard are primarily based on Part 1 of the 2009 edition of the *NEHRP Recommended Seismic Provisions for New Buildings and Other Structures* (FEMA 2009), which was prepared by the Building Seismic Safety Council (BSSC) under sponsorship of the Federal Emergency Management Agency (FEMA) as part of its contribution to the National Earthquake Hazards Reduction Program (NEHRP). The National Institute of Standards and Technology (NIST) is the lead agency for NEHRP, the federal government’s long-term program to reduce the risks to life and property posed by earthquakes in the United States. Since 1985, the NEHRP provisions have been updated every three to five years. The efforts by BSSC to produce the NEHRP provisions were preceded by work performed by the Applied Technology Council (ATC) under sponsorship of the National Bureau of Standards (NBS)—now NIST—which originated after the 1971 San Fernando Valley earthquake. These early efforts demonstrated the design rules of that time for seismic resistance but had some serious shortcomings. Each subsequent major earthquake has taught new lessons. The NEHRP agencies (FEMA, NIST, the National Science Foundation [NSF], and the U.S. Geological Survey [USGS]), ATC, BSSC, ASCE, and others have endeavored to work individually and collectively to improve each succeeding document to provide state-of-the-art earthquake engineering design and construction provisions and to ensure that the provisions have nationwide applicability.

Content of Commentary. This commentary is updated from the enhanced commentary to ASCE/SEI 7-10 that was based substantially on Part 2, Commentary, of the 2009 *NEHRP Recommended Seismic Provisions for New Buildings and Other Structures* (FEMA 2009). For additional background on the earthquake provisions contained in Chapters 11 through 23 of ASCE/SEI 7-10, the reader is referred to *Recommended Lateral Force Requirements and Commentary* (SEAOC 1999).

Nature of Earthquake “Loads.” Earthquakes load structures indirectly through ground motion. As the ground shakes, a structure responds. The response vibration produces structural deformations with associated strains and stresses. The computation of dynamic response to earthquake ground shaking is complex. The design forces prescribed in this standard are intended only as approximations to generate internal forces suitable for proportioning the strength and stiffness of structural elements and for estimating the deformations (when multiplied by the deflection amplification factor, C_d) that would occur in the same structure in the event of the design-level earthquake ground motion (not MCE_R).

The basic methods of analysis in the standard use the common simplification of a response spectrum. A response spectrum for a specific earthquake ground motion provides the maximum value of response for elastic single-degree-of-freedom oscillators as a function of period without the need to reflect the total response history for every period of interest. The design response spectrum specified in Section 11.4 and used in the basic methods of analysis in Chapter 12 is a smoothed and normalized approximation for many different recorded ground motions.

The design limit state for resistance to an earthquake is unlike that for any other load within the scope of ASCE 7. The earthquake limit state is based upon system performance, not member performance, and considerable energy dissipation through repeated cycles of inelastic straining is assumed. The reason is the large demand exerted by the earthquake and the associated high cost of providing enough strength to maintain linear elastic response in ordinary buildings. This unusual limit state means that several conveniences of elastic behavior, such as the principle of superposition, are not applicable and makes it difficult to separate design provisions for loads from those for resistance. This difficulty is the reason Chapter 14 of the standard contains so many provisions that modify customary requirements for proportioning and detailing structural members and systems. It is also the reason for the construction quality assurance requirements.

Use of Allowable Stress Design Standards. The conventional design of almost all masonry structures and many wood and steel structures has been accomplished using allowable stress design (ASD). Although the fundamental basis for the earthquake loads in Chapters 11 through 23 is a strength limit state beyond the first yield of the structure, the provisions are written such that conventional ASD methods can be used by the design engineer. Conventional ASD methods may be used in one of two ways:

1. The earthquake load as defined in Chapters 11 through 23 may be used directly in allowable stress load combinations of Section 2.4, and the resulting stresses may be compared directly with conventional allowable stresses.
2. The earthquake load may be used in strength design load combinations, and resulting stresses may be compared with amplified allowable stresses (for those materials for which the design standard gives the amplified allowable stresses, e.g., masonry).

Federal Government Construction. The Interagency Committee on Seismic Safety in Construction has prepared an order executed by the president (Executive Order 12699 2016) that all federally owned or leased building construction, as well as federally regulated and assisted construction, should be constructed to mitigate seismic hazards and that the NEHRP provisions are deemed to be the suitable standard. It is expected that this standard would be deemed equivalent, but the reader should bear in mind that there are certain differences.

C11.1.1 Purpose.

The purpose of Section 11.1.1 is to clarify that the detailing requirements and limitations prescribed in this section and referenced standards are still required even when the design load combinations involving the wind forces of Chapters 26 through 29 produce greater effects than the design load combinations involving the earthquake forces of Chapters 11 through 23. This detailing is required so that the structure resists, in a ductile manner, potential seismic loads in excess of the prescribed wind loads. A proper, continuous load path is an obvious design requirement, but experience has shown that it is often overlooked and that significant damage and collapse can result. The basis for this design requirement is twofold:

1. To ensure that the design has fully identified the seismic force-resisting system and its appropriate design level and
2. To ensure that the design basis is fully identified for the purpose of future modifications or changes in the structure.

Detailed requirements for analyzing and designing this load path are given in the appropriate design and materials chapters.

C11.1.2 Scope.

Certain structures are exempt for the following reasons:

Exemption 1—Detached wood-frame dwellings not exceeding two stories above grade plane constructed in accordance with the prescriptive provisions of the International Residential Code (IRC) for light-frame wood construction, including all applicable IRC seismic provisions and limitations, are deemed capable of resisting the anticipated seismic forces. Detached one- and two-story wood-frame dwellings generally have performed well even in regions of higher seismicity. Therefore, within its scope, the IRC adequately provides the level of safety required for buildings. The structures that do not meet the prescriptive limitations of the IRC are required to be designed and constructed in accordance with the International Building Code (IBC) and the ASCE 7 provisions adopted therein.

Exemption 2—Agricultural storage structures generally are exempt from most code requirements because such structures are intended only for incidental human occupancy and represent an exceptionally low risk to human life.

Exemption 3—Bridges, transmission towers, nuclear reactors, and other structures with special configurations and uses are not covered. The regulations for buildings and buildinglike structures presented in this document do not adequately address the design and performance of such special structures.

ASCE 7 is not retroactive and usually applies to existing structures only when there is an addition, change of use, or alteration. Minimum acceptable seismic resistance of existing buildings is a policy issue normally set by the authority having jurisdiction. Appendix 11B of the standard contains rules of application for basic conditions. ASCE 41 (2014) provides technical guidance but does not contain policy recommendations. A chapter in the *International Building Code (IBC)* applies to alteration, repair, addition, and change of occupancy of existing buildings, and the International Code Council maintains the *International Existing Building Code (IEBC)* and associated commentary.

C11.1.3 Applicability.

Industrial buildings may be classified as nonbuilding structures in certain situations for the purposes of determining seismic design coefficients and factors, system limitations, height limits, and associated detailing requirements. Many industrial building structures have geometries and/or framing systems that are different from the broader class of occupied structures addressed by Chapter 12, and the limited nature of the occupancy associated with these buildings reduces the hazard associated with their performance in earthquakes. Therefore, when the occupancy is limited primarily to maintenance and monitoring operations, these structures may be designed in accordance with the provisions of Section 15.5 for nonbuilding structures similar to buildings. Examples of such structures include, but are not limited to, boiler buildings, aircraft hangars, steel mills, aluminum smelting facilities, and other automated manufacturing facilities, whereby the occupancy restrictions for such facilities should be uniquely reviewed in each case. These structures may be clad or open structures.

C11.1.4 Alternate Materials and Methods of Construction.

It is not possible for a design standard to provide criteria for the use of all possible materials and their combinations and methods of construction, either existing or anticipated. This section serves to emphasize that the evaluation and approval of alternate materials and methods require a recognized and accepted approval system. The requirements for materials and methods of construction contained within the document represent the judgment of the best use of the materials and methods based on well-established expertise and historical seismic performance. It is important that any replacement or substitute be evaluated with an understanding of all the ramifications of performance, strength, and durability implied by the standard.

Until needed standards and agencies are created, authorities that have jurisdiction need to operate on the basis of the best evidence available to substantiate any application for alternates. If accepted standards are lacking, applications for alternative materials or methods should be supported by test data obtained from test data requirements in Section 1.3.1. The tests should simulate expected load and deformation conditions to which the system, component, or assembly may be subjected during the service life of the structure. These conditions, when applicable, should include several cycles of full reversals of loads and deformations in the inelastic range.

C11.1.5 Quality Assurance.

Quality assurance (QA) requirements are essential for satisfactory performance of structures in earthquakes. QA requirements are usually incorporated in building codes as special inspections and tests or as structural observation, and they are enforced through the authorities having jurisdiction. Many building code requirements parallel or reference the requirements found in standards adopted by ASCE 7. Where special inspections and testing, or structural observations are not specifically required by the building code, a level of quality assurance is usually provided by inspectors employed by the authority having jurisdiction.

Where building codes are not in force or where code requirements do not apply to or are inadequate for a unique structure or system, the registered design professional for the structure or system should develop a QA program to verify that the structure or system is constructed as designed. A QA program could be modeled on similar provisions in the building code or applicable standards.

The quality assurance plan is used to describe the QA program to the owner, the authority having jurisdiction, and to all other participants in the QA program. As such, the QA plan should include definitions of roles and responsibilities of the participants. It is anticipated that in most cases the owner of the project would be responsible for implementing the QA plan.

C11.2 DEFINITIONS

ATTACHMENTS, COMPONENTS, AND SUPPORTS: The distinction among attachments, components, and supports is necessary to the understanding of the requirements for nonstructural components and nonbuilding structures. Common cases associated with nonstructural elements are illustrated in Figure C11.2-1. The definitions of attachments, components, and supports are generally applicable to components with a defined envelope in the as-manufactured condition and for which additional supports and attachments are required to provide support in the as-built condition. This distinction may not always be clear, particularly when the component is equipped with prefabricated supports; therefore, judgment must be used in the assignment of forces to specific elements in accordance with the provisions of Chapter 13.

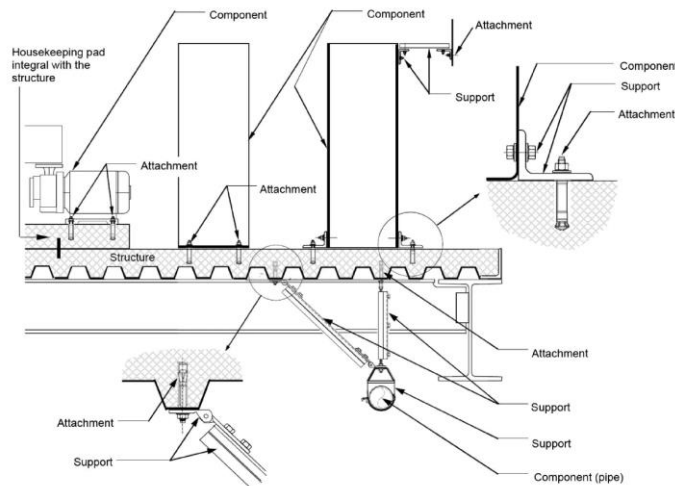

FIGURE C11.2-1 Examples of Attachments, Components, and Supports

BASE: The following factors affect the location of the seismic base:

- location of the grade relative to floor levels,
- soil conditions adjacent to the building,
- openings in the basement walls,
- location and stiffness of vertical elements of the seismic force-resisting system,
- location and extent of seismic separations,
- depth of basement,
- manner in which basement walls are supported,
- proximity to adjacent buildings, and
- slope of grade.

For typical buildings on level sites with competent soils, the base is generally close to the grade plane. For a building without a basement, the base is generally established near the ground-level slab elevation, as shown in Figure C11.2-2. Where the vertical elements of the seismic force-resisting system are supported on interior footings or pile caps, the base is the top of these elements. Where the vertical elements of the seismic force-resisting system are supported on top of perimeter foundation walls, the base is typically established at the top of the foundation walls. Often vertical elements are supported at various elevations on the top of footings, pile caps, and perimeter foundation walls. Where this occurs, the base is generally established as the lowest elevation of the tops of elements supporting the vertical elements of the seismic force-resisting system.

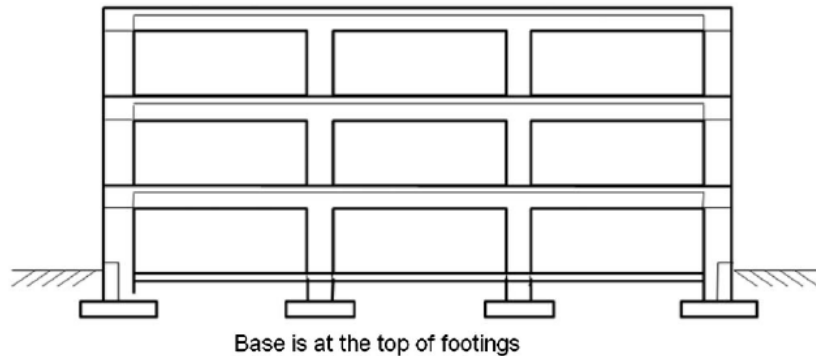

FIGURE C11.2-2 Base for a Level Site

For a building with a basement located on a level site, it is often appropriate to locate the base at the floor closest to grade, as shown in Figure C11.2-3. If the base is to be established at the level located closest to grade, the soil profile over the depth of the basement should not be liquefiable in the MCE_G ground motion. The soil profile over the depth of the basement also should not include quick and highly sensitive clays or weakly cemented soils prone to collapse in the MCE_G ground motion. Where liquefiable soils or soils susceptible to failure or collapse in an MCE_G ground motion are located within the depth of the basement, the base may need to be located below these soils rather than close to grade. Stiff soils are required over the depth of the basement because seismic forces are transmitted to and from the building at this level and over the height of the basement walls. The engineer of record is responsible for establishing whether the soils are stiff enough to transmit seismic forces near grade. For tall or heavy buildings or where soft soils are present within the depth of the basement, the soils may compress laterally too much during an earthquake to transmit seismic forces near grade. For these cases, the base should be located at a level below grade.



FIGURE C11.2-3 Base at Ground Floor Level

In some cases, the base may be at a floor level above grade. For the base to be located at a floor level above grade, stiff foundation walls on all sides of the building should extend to the underside of the elevated level considered the base. Locating the base above grade is based on the principles for the two-stage equivalent lateral force procedure for a flexible upper portion of a building with one-tenth the stiffness of the lower portion of the building, as permitted in Section 12.2.3.2. For a floor level above grade to be considered the base, it generally should not be above grade more than one-half the height of the basement story, as shown in Figure C11.2-4. Figure C11.2-4 illustrates the concept of the base level located at the top of a floor level above grade, which also includes light-frame floor systems that rest on top of stiff basement walls or stiff crawl space stem walls of concrete or masonry construction.

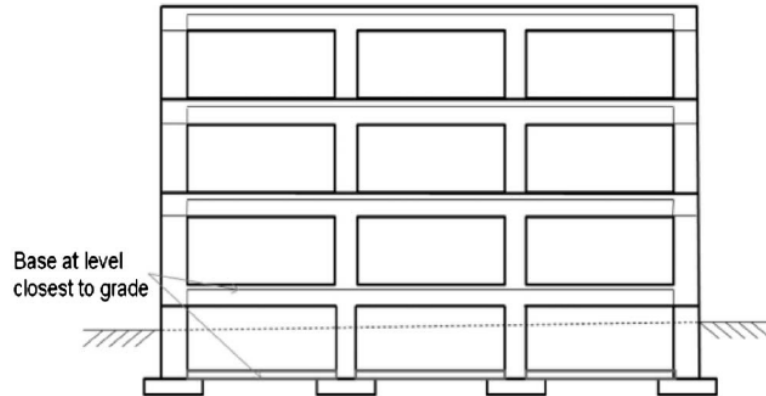

FIGURE C11.2-4 Base at Level Closest to Grade Elevation

A condition where the basement walls that extend above grade on a level site may not provide adequate stiffness is where the basement walls have many openings for items such as light wells, areaways, windows, and doors, as shown in Figure C11.2-5. Where the basement wall stiffness is inadequate, the base should be taken as the level close to but below grade. If all of the vertical elements of the seismic force-resisting system are located on top of basement walls and there are many openings in the basement walls, it may be appropriate to establish the base at the bottom of the openings. Another condition where the basement walls may not be stiff enough is where the vertical elements of the seismic force-resisting system are long concrete shear walls extending over the full height and length of the building, as shown in Figure C11.2-6. For this case, the appropriate location for the base is the foundation level of the basement walls.

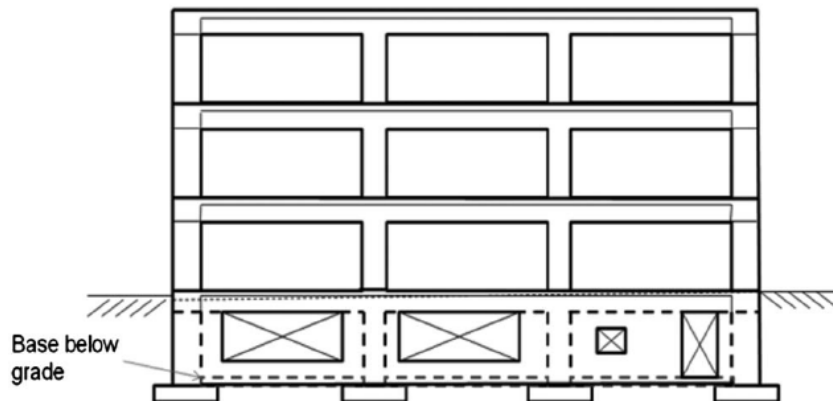

FIGURE C11.2-5 Base Below Substantial Openings in Basement Wall

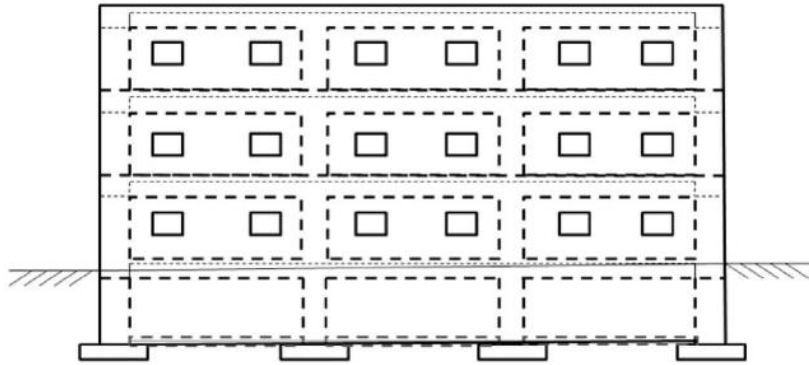

FIGURE C11.2-6 Base at Foundation Level Where There Are Full-Length Exterior Shear Walls

Where the base is established below grade, the weight of the portion of the story above the base that is partially above and below grade must be included as part of the effective seismic weight. If the equivalent lateral force procedure is used, this procedure can result in disproportionately high forces in upper levels because of a large mass at this lowest level above the base. The magnitude of these forces can often be mitigated by using the two-stage equivalent lateral force procedure where it is allowed or by using dynamic analysis to determine force distribution over the height of the building. If dynamic analysis is used, it may be necessary to include multiple modes to capture the required mass participation, unless soil springs are incorporated into the model. Incorporation of soil springs into the model generally reduces seismic forces in the upper levels. With one or more stiff stories below more flexible stories, the dynamic behavior of the structure may result in the portion of the base shear from the first mode being less than the portion of base shear from higher modes.

Other conditions may also necessitate establishing the base below grade for a building with a basement that is located on a level site. Such conditions include those where seismic separations extend through all floors, including those located close to and below grade; those where the floor diaphragms close to and below grade are not tied to the foundation wall; those where the floor diaphragms, including the diaphragm for the floor close to grade, are flexible; and those where other buildings are located nearby.

For a building with seismic separations extending through the height of the building including levels close to and below grade, the separate structures are not supported by the soil against a basement wall on all sides in all directions. If there is only one joint through the building, assigning the base to the level close to grade may still be appropriate if the soils over the depth of the basement walls are stiff and the diaphragm is rigid. Stiff soils are required so that the seismic forces can be transferred between the soils and basement walls in both bearing and side friction. If the soils are not stiff, adequate side friction may not develop for movement in the direction perpendicular to the joint.

For large footprint buildings, seismic separation joints may extend through the building in two directions and there may be multiple parallel joints in a given direction. For individual structures within these buildings, substantial differences in the location of the center of rigidity for the levels below grade relative to levels above grade can lead to torsional response. For such buildings, the base should usually be at the foundation elements below the basement or the highest basement slab level where the separations are no longer provided.

Where floor levels are not tied to foundation walls, the base may need to be located well below grade at the foundation level. An example is a building with tieback walls and posttensioned floor slabs. For such a structure, the slabs may not be tied to the wall to allow relative movement between them. In other cases, a soft joint may be provided. If shear forces cannot be transferred between the wall and a ground level or basement floor, the location of the base depends on whether forces can be transferred through bearings

between the floor diaphragm and basement wall and between the basement wall and the surrounding soils. Floor diaphragms bearing against the basement walls must resist the compressive stress from earthquake forces without buckling. If a seismic or expansion joint is provided in one of these buildings, the base almost certainly needs to be located at the foundation level or a level below grade where the joint no longer exists.

If the diaphragm at grade is flexible and does not have substantial compressive strength, the base of the building may need to be located below grade. This condition is more common with existing buildings. Newer buildings with flexible diaphragms should be designed for compression to avoid the damage that can otherwise occur.

Proximity to other structures can also affect where the base should be located. If other buildings with basements are located adjacent to one or more sides of a building, it may be appropriate to locate the base at the bottom of the basement. The closer the adjacent building is to the building, the more likely it is that the base should be below grade.

For sites with sloping grade, many of the same considerations for a level site are applicable. For example, on steeply sloped sites, the earth may be retained by a tieback wall so that the building does not have to resist the lateral soil pressures. For such a case, the building is independent of the wall, so the base should be located at a level close to the elevation of grade on the side of the building where it is lowest, as shown in Figure C11.2-7. Where the building's vertical elements of the seismic force-resisting system also resist lateral soil pressures, as shown in Figure C11.2-8, the base should also be located at a level close to the elevation of grade on the side of the building where grade is low. For these buildings, the seismic force-resisting system below highest grade is often much stiffer than the system used above it, as shown in Figure C11.2-9, and the seismic weights for levels close to and below highest grade are greater than for levels above highest grade. Use of a two-stage equivalent lateral force procedure can be useful for these buildings.

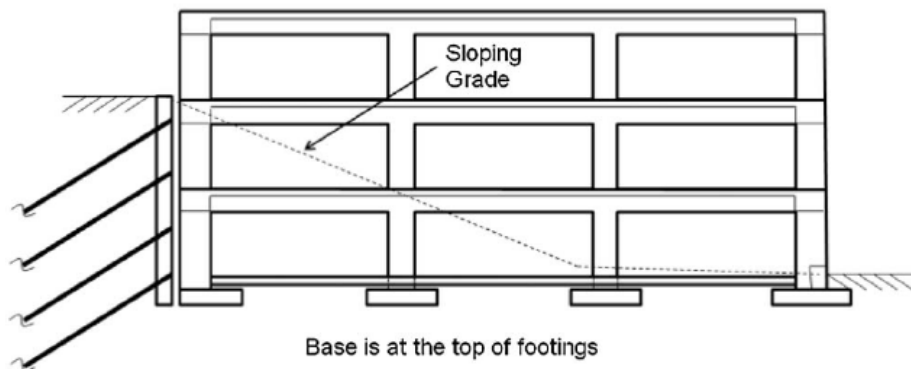

FIGURE C11.2-7 Building with Tie-Back or Cantilevered Retaining Wall That Is Separate from the Building

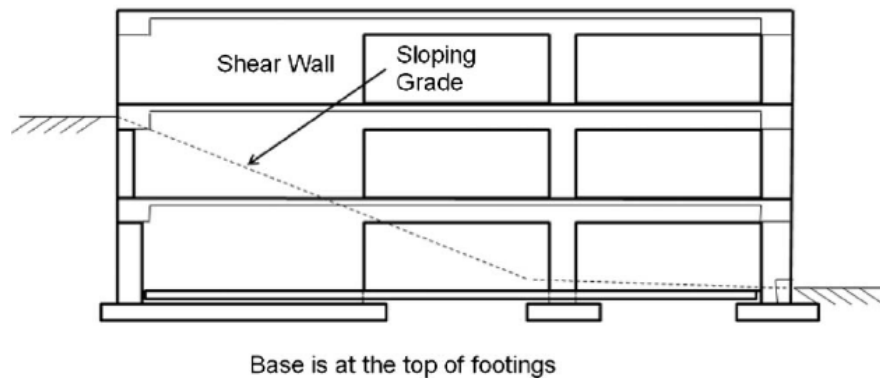

FIGURE C11.2-8 Building with Vertical Elements of the Seismic Force-Resisting System Supporting Lateral Earth Pressures

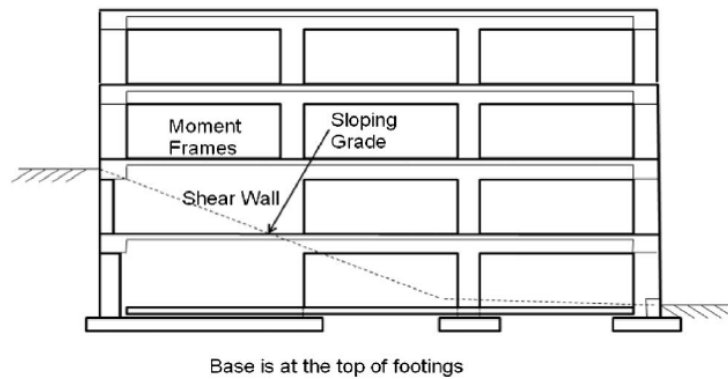

FIGURE C11.2-9 Building with Vertical Elements of the Seismic Force-Resisting System Supporting Lateral Earth Pressures

Where the site is moderately sloped such that it does not vary in height by more than a story, stiff walls often extend to the underside of the level close to the elevation of high grade, and the seismic force-resisting system above grade is much more flexible above grade than it is below grade. If the stiff walls extend to the underside of the level close to high grade on all sides of the building, locating the base at the level closest to high grade may be appropriate. If the stiff lower walls do not extend to the underside of the level located closest to high grade on all sides of the building, the base should be assigned to the level closest to low grade. If there is doubt as to where to locate the base, it should conservatively be taken at the lower elevation.

DISTRIBUTION SYSTEM: For the purposes of determining the anchorage of components in Chapter 13, a distribution system is characterized as a series of individual in-line mechanical or electrical components that have been physically attached together to function as an interconnected system. In general, the individual in-line components of a distribution system are comparable to those of the pipe, duct, or electrical raceway so that the overall seismic behavior of the system is relatively uniform along its length. For example, a damper in a duct or a valve in a pipe is sufficiently similar to the weight of the duct or pipe itself, as opposed to a large fan or large heat exchanger. If a component is large enough to require support that is independent of the piping, duct, or conduit to which it is attached, it should likely be treated as a discrete component with regard to both exemptions and general design requirements. Representative distribution systems are listed in Table 13.6-1.

FLEXURE-CONTROLLED DIAPHRAGM: An example of a flexure-controlled diaphragm is a cast-in-place concrete diaphragm, where the flexural yielding mechanism would typically be yielding of the chord tension reinforcement.

SHEAR-CONTROLLED DIAPHRAGM: Shear-controlled diaphragms fall into two main categories. The first category is diaphragms that cannot develop a flexural mechanism because of aspect ratio, chord member strength, or other constraints. The second category is diaphragms that are intended to yield in shear rather than in flexure. Wood-sheathed diaphragms, for example, typically fall in the second category.

STORY ABOVE GRADE PLANE: Figure C11.2-10 illustrates this definition.

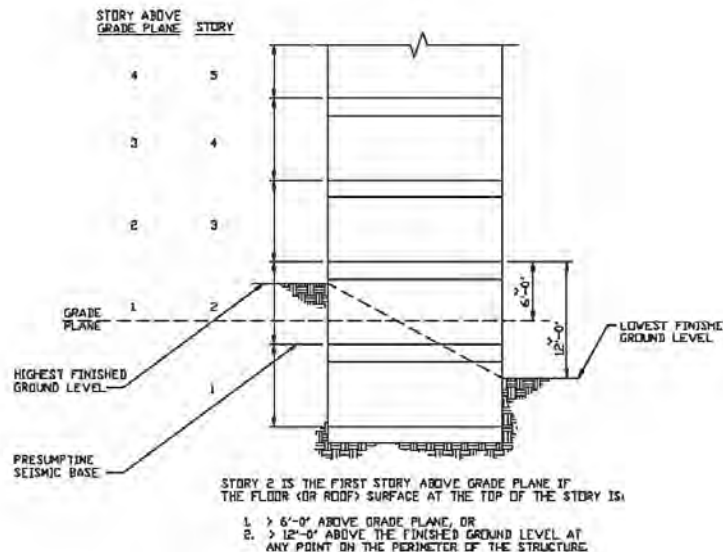

FIGURE C11.2-10 Illustration of Definition of Story above Grade Plane

TRANSFER FORCES: Transfer forces are diaphragm forces that are not caused by the acceleration of the diaphragm inertial mass. Transfer forces occur because of discontinuities in the vertical elements of the seismic force-resisting system or because of changes in stiffness in these vertical elements from one story to the next, even if there is no discontinuity. Additionally, buildings that combine frames and shear walls, which would have different deflected shapes under the same loading, also develop transfer forces in the diaphragms that constrain the frames and shear walls to deform together; this development is especially significant in dual systems.

C11.3 SYMBOLS

The provisions for precast concrete diaphragm design are intended to ensure that yielding, when it occurs, is ductile. Since yielding in shear is generally brittle at precast concrete connections, an additional overstrength factor, Ω_v , has been introduced; the required shear strength for a precast diaphragm is required to be amplified by this factor. This term is added to the symbols.

δ_{MDD} = This symbol refers to in-plane diaphragm deflection and is therefore designated with a lower-case delta. Note that the definition for δ_{MDD} refers to “lateral load” without any qualification, and the definition for Δ_{ADVE} refers to “tributary lateral load equivalent to that used in the computation of δ_{MDD} .” This equivalency is an important concept that was part of the 1997 Uniform Building Code (UBC) (ICBO 1997) definition for a flexible diaphragm.

Ω_v = The provisions for precast concrete diaphragm design are intended to ensure that yielding, when it occurs, is ductile. Since yielding in shear is generally brittle at precast concrete connections, an additional overstrength factor, Ω_v , has been introduced; the required shear strength for a precast diaphragm is required to be amplified by this factor. This term is added to the symbols.

C11.4 SEISMIC GROUND MOTION VALUES

The theoretical basis for the mapped values of the MCE_R ground motions in the 2020 NEHRP Recommended Provisions (ASCE 7-22) is identical to that in the 2015 NEHRP Recommended Provisions (ASCE 7-16) and in the 2009 NEHRP Recommended Provisions (ASCE 7-10). ASCE 7-22 MCE_R ground motions (like those of ASCE 7-16 and ASCE 7-10) are significantly different from mapped values of MCE ground motions in earlier editions of ASCE 7. These differences include use of (1) probabilistic ground motions that are based on uniform risk, rather than uniform hazard, (2) deterministic ground motions that are based on the 84th percentile (approximately 1.8 times median), rather than 1.5 times median response spectral acceleration for sites near active faults, and (3) ground motion intensity that is based on maximum rather than average (geometric mean) response spectral acceleration in the horizontal plane. These differences are explained in detail in the Commentary of the 2009 *NEHRP Recommended Provisions*. Except for determining the MCE_G PGA values in Chapters 11 and 21, the mapped values are given as MCE_R spectral values.

While the theoretical basis for MCE_R ground motions has not changed from ASCE 7-16 (and prior editions), ASCE 7-22 now uses a multi-period response spectra (MPRS) to improve the accuracy of the frequency content of earthquake design ground motions and to enhance the reliability of the seismic design parameters derived from these ground motions. These improvements make better use of the available earth science which has, in general, sufficiently advanced to accurately define spectral response for different site conditions over a broad range of periods and eliminate the need for site-specific hazard analysis required by ASCE 7-16 for certain (soft soil) sites, as discussed below.

During the closing months of the 2015 Building Seismic Safety Council, Provisions Update Committee (PUC) cycle, a study was undertaken of the compatibility of current Site Class coefficients F_a and F_v with the ground motion relations used by USGS to produce the design maps (Kircher & Associates 2015). In the course of this study, it was discovered that the standard three-domain spectral shape defined by the short-period response spectral acceleration parameter, S_{DS} , the 1-second response spectral acceleration parameter, S_{D1} , and long-period transition period, T_L , is not appropriate for soft soil sites (Site Class D or softer), in particular, where ground motion hazard is dominated by large magnitude events. Specifically, on such sites, the standard spectral shape substantially understates spectral demand for moderately long period structures. The PUC initiated a proposal to move to specification of spectral acceleration values over a range of periods, abandoning the present three-domain format, as this would provide better definition of likely ground motion demands. However, this proposal was ultimately not adopted due to both the complexity of implementing such a revision in the design procedure and time constraints. Instead, the PUC adopted a proposal prohibiting the general use of the three-parameter spectrum, and instead requiring site-specific hazard determination for longer period structures on soft soil sites.

Subsequently, Project 17 (NIBS 2019) was charged with re-evaluating the use of multi-period response spectra as a replacement or supplement to the present three-domain spectral definition and to consider how the basic design procedures embedded in ASCE 7 should be modified for compatibility with the multi-period spectra. As a result, Project 17 developed (and unanimously approved) a comprehensive multi-period response spectra (MPRS) proposal that was subsequently adopted (with changes) by the 2020 NEHRP Recommended Provisions, FEMA P-2082 (FEMA 2020) which form the basis for related changes to ASCE 7-22. An Applied Technology Council report of the ATC-136-1 Project compliments the changes to ASCE 7-22 by providing methods for developing MPRS of those regions (i.e., Alaska, Hawaii, Puerto Rico, Guam and American Samoa) for which ground motion relations have not yet been used by the USGS to fully define all periods and site classes of interest (ATC 2019).

C11.4.1 Near-Fault Sites.

In addition to very large accelerations, ground motions on sites located close to the zone of fault rupture of large-magnitude earthquakes can exhibit impulsive characteristics as well as unique directionality not typically recorded at sites located more distant from the zone of rupture. In past earthquakes, these characteristics have been observed to be particularly destructive. Accordingly, this standard establishes more restrictive design criteria for structures located on sites where such ground motions may occur. The standard also requires direct consideration of these unique characteristics in selection and scaling of ground motions used in nonlinear response history analysis and for the design of structures using seismic isolation or energy-dissipation devices when located on such sites.

The distance from the zone of fault rupture at which these effects can be experienced is dependent on a number of factors, including the rupture type, depth of fault, magnitude, and direction of fault rupture. Therefore, a precise definition of what constitutes a near-fault site is difficult to establish on a general basis. This standard uses two categorizations of near-fault conditions, both based on the distance of a site from a known active fault, capable of producing earthquakes of a defined magnitude or greater, and having average annual slip rates of nonnegligible amounts. These definitions were first introduced in the 1997 UBC (ICBO 1997). Figure C11.4-1 illustrates the means of determining the distance of a site from a fault, where the fault plane dips at an angle relative to the ground surface.

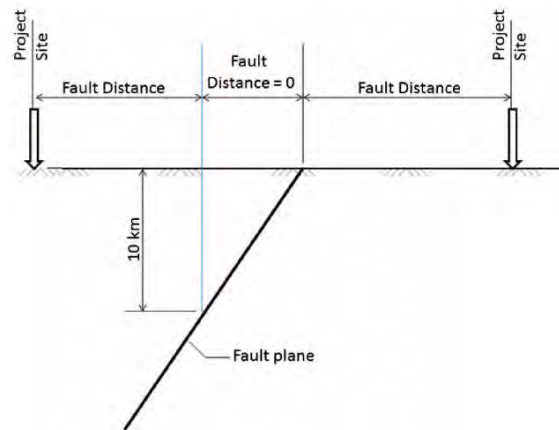

FIGURE C11.4-1 Fault Distance for Various Project Site Locations

C11.4.2 Site Class.

Site class is defined in terms of average shear wave velocity (v_s) in accordance with Table 20.2-1 of Chapter 20. Table 20.2-1 includes the six site classes of ASCE 7-16 (A, B, C, D, E and F) plus three new site classes (BC, CD and DE) that provide better resolution of site shear wave velocity and associated site amplification for common site conditions. The new site classes allow for more accurate derivation of the amplitude and frequency content of earthquake ground motions, and their variation with shaking intensity (nonlinear effects). The additional site classes are of particular importance to the characterization of long period ground motions for softer sites.

C11.4.2.1 Default Site Class.

The “default” site class is defined as the most critical response spectral acceleration of typical soil site conditions (Site Classes C, CD and D) to provide a conservative basis for design where site class is not known (e.g., due to insufficient geological investigation). Enveloping of Site Classes C, CD and D is consistent with ASCE 7-16 which requires the more critical of Site Class C and D to be used for design where site class is not known. Use of the default site class for design presumes that the site does not have

soft soil site conditions (i.e., Site Class DE, E or F site conditions) and should not be used for design where such site conditions could reasonably be expected to exist.

C11.4.3 Risk-Targeted Maximum Considered Earthquake (MCER) Spectral Response Acceleration Parameters.

“Mapped” values of seismic parameters S_S , S_I , S_{MS} and S_{MI} are archived in the USGS Seismic Design Geodatabase at gridded locations across United States regions of interest and provided online by the USGS Seismic Design Web Service for user-specified site location (e.g., latitude, longitude) and site class. The USGS web service spatially interpolates between the gridded values of these parameters based on site location (i.e., latitude and longitude). Chapter 22 provides print copies of seismic parameters S_{MS} and S_{MI} for default site conditions. Seismic parameters S_{MS} and S_{MI} (and S_{DS} and S_{DI}) incorporate site effects, eliminating the need for the tables of site factors F_a and F_v of ASCE 7-16.

C11.4.4 Design Spectral Acceleration Parameters.

Design in ASCE 7 (e.g., Chapter 12) is performed for earthquake demands that are two-thirds of MCE_R ground motions. As set forth in Section 11.4.4, two additional parameters S_{DS} and S_{DI} are used to define design spectral accelerations.

Values of seismic parameters S_{DS} and S_{DI} (two-thirds S_{MS} and two-thirds S_{MI}) are provided online by the USGS Seismic Design Web Service for user-specified site location (e.g., latitude, longitude) and site class. Values of seismic parameters S_{DS} and S_{DI} provided by the USGS are based on the multi-period design response spectrum (Section 11.4.5.1) of the site of interest and the requirements of Section 21.4 (for determining values of S_{DS} and S_{DI} from a site-specific design response spectrum).

C11.4.5 Design Response Spectrum.

The design response spectrum (and MCE_R response spectrum of Section 11.4.6) are defined by either (1) a multi-period response spectrum (Section 11.4.5.1) or (2) a two-period response spectrum (Section 11.4.5.2), unless the design is based on site-specific ground motions (Section 21.3). The multi-period design response spectrum provides a more accurate representation of the frequency content of design ground motions and is the preferred characterization of spectral response. The two-period design response spectrum is the same as that of ASCE 7-16 which relies on a simpler characterization of the frequency content of design ground motions (Figure 11.4-1) based on the values of seismic parameters, S_{DS} and S_{DI} (and T_L). The two-period design response spectrum is retained in ASCE 7-22 as an alternative characterization of ground motions for design where multi-period spectra are not available (e.g., from the USGS).

C11.4.5.1 Multi-Period Design Response Spectrum.

Sets of multi-period MCE_R response spectra (5% damping) at 22 response periods (i.e., 0.0 s, 0.01 s, 0.02 s, 0.03 s, 0.05 s, 0.075 s, 0.1 s, 0.15 s, 0.2 s, 0.25 s, 0.3 s, 0.4 s, 0.5 s, 0.75 s, 1.0 s, 1.5 s, 2.0 s, 3.0 s, 4.0 s, 5.0 s, 7.5 s and 10 s) are archived in the USGS Seismic Design Geodatabase at gridded locations across United States regions of interest. The USGS Seismic Design Web Service, for the site location and site class of interest, spatially interpolates between the gridded sets of multi-period MCE_R response spectra based on site location (i.e., latitude and longitude). Multi-period design response spectrum is constructed from two-thirds of these values by linear interpolation for response periods less than 10 s and by extrapolation for response periods greater than 10 s.

At response periods beyond 10 s, values of the multi-period design response spectrum are assumed to decrease from the value of the design response spectrum value at 10 s as the inverse of the period, T , where T is less than T_L and/or as inverse of the square of the period, T^2 , where T is greater than T_L , essentially following the same approach as that used to construct the two-period spectrum (Section 11.4.5.2) at very long-periods.

C11.4.5.2 Two-Period Design Response Spectrum.

The two-period design response spectrum (Figure 11.4-1) consists of several segments. The constant-acceleration segment covers the period band from T_0 to T_s ; response accelerations in this band are constant and equal to S_{DS} . The constant-velocity segment covers the period band from T_s to T_L , and the response accelerations in this band are proportional to $1/T$ with the response acceleration at a 1-s period equal to S_{D1} . The long-period portion of the design response spectrum is defined on the basis of the parameter, T_L , the period that marks the transition from the constant-velocity segment to the constant-displacement segment of the design response spectrum. Response accelerations in the constant-displacement segment, where $T \geq T_L$, are proportional to $1/T^2$. Values of T_L are provided on maps in Figs. 22-14 through 22-17.

The T_L maps were prepared following a two-step procedure. First, a correlation between earthquake magnitude and T_L was established. Then, the modal magnitude from deaggregation of the ground-motion seismic hazard at a 2-s period (a 1-s period for Hawaii) was mapped. Details of the procedure and the rationale for it are found in Crouse et al. (2006).

C11.4.6 SITE-SPECIFIC GROUND MOTION PROCEDURES.

Site-specific ground motions are permitted for design of any structure and are required for design of certain structures and certain site soil conditions. The objective of a site-specific ground motion analysis is to determine ground motions for local seismic and site conditions with higher confidence than is possible using the general procedure of Section 11.4.

As noted earlier, the site-specific procedures of Chapter 21 are the same as those used by the U.S. Geological Survey to develop the mapped values of MCE_R ground motion. Unless significant differences in local seismic and site conditions are determined by a site-specific analysis of earthquake hazard, site-specific ground motions would not be expected to differ significantly from those of the mapped values of MCE_R ground motions prepared by the USGS.

C11.5 IMPORTANCE FACTOR AND RISK CATEGORY

Large earthquakes are rare events that include severe ground motions. Such events are expected to result in damage to structures even if they were designed and built in accordance with the minimum requirements of the standard. The consequence of structural damage or failure is not the same for the various types of structures located within a given community. Serious damage to certain classes of structures, such as critical facilities (e.g., hospitals), disproportionately affects a community. The fundamental purpose of this section and of subsequent requirements that depend on this section is to improve the ability of a community to recover from a damaging earthquake by tailoring the seismic protection requirements to the relative importance of a structure. That purpose is achieved by requiring improved performance for structures that

1. Are necessary to response and recovery efforts immediately after an earthquake,
2. Present the potential for catastrophic loss in the event of an earthquake, or
3. House a large number of occupants or occupants less able to care for themselves than the average.

The first basis for seismic design in the standard is that structures should have a suitably low likelihood of collapse in the rare events defined as the maximum considered earthquake (MCE) ground motion. A second basis is that life-threatening damage, primarily from failure of nonstructural components in and on structures, is unlikely in a design earthquake ground motion (defined as two-thirds of the MCE). Given the

occurrence of ground motion equivalent to the MCE, a population of structures built to meet these design objectives probably still experiences substantial damage in many structures, rendering these structures unfit for occupancy or use. Experience in past earthquakes around the world has demonstrated that there is an immediate need to treat injured people, to extinguish fires and prevent conflagration, to rescue people from severely damaged or collapsed structures, and to provide shelter and sustenance to a population deprived of its normal means. These needs are best met when structures essential to response and recovery activities remain functional.

This standard addresses these objectives by requiring that each structure be assigned to one of the four Risk Categories presented in Chapter 1 and by assigning an Importance Factor, I_e , to the structure based on that Risk Category. (The two lowest categories, I and II, are combined for all purposes within the seismic provisions.) The Risk Category is then used as one of two components in determining the Seismic Design Category (see Section C11.6) and is a primary factor in setting drift limits for building structures under the design earthquake ground motion (see Section C12.12).

Figure C11.5-1 shows the combined intent of these requirements for design. The vertical scale is the likelihood of the ground motion; the MCE is the rarest considered. The horizontal scale is the level of performance intended for the structure and attached nonstructural components, which range from collapse to operational. The basic objective of collapse prevention at the MCE for ordinary structures (Risk Category II) is shown at the lower right by the solid triangle; protection from life-threatening damage at the design earthquake ground motion (defined by the standard as two-thirds of the MCE) is shown by the hatched triangle. The performance implied for higher Risk Categories III and IV is shown by squares and circles, respectively. The performance anticipated for less severe ground motion is shown by open symbols.

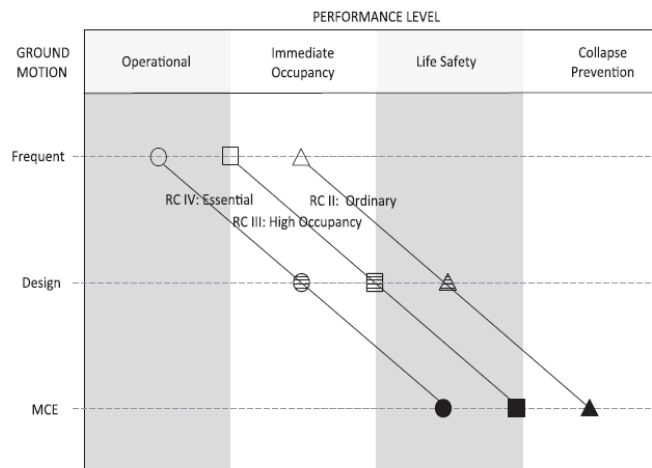

FIGURE C11.5-1 Expected Performance as Related to Risk Category and Level of Ground Motion

C11.5.1 Importance Factor.

The Importance Factor, I_e , is used throughout the standard in quantitative criteria for strength. In most of those quantitative criteria, the Importance Factor is shown as a divisor on the factor R or R_p to reduce damage for important structures in addition to preventing collapse in larger ground motions. The R and R_p factors adjust the computed linear elastic response to a value appropriate for design; in many structures, the largest component of that adjustment is ductility (the ability of the structure to undergo repeated cycles

of inelastic strain in opposing directions). For a given strength demand, reducing the effective R factor (by means of the Importance Factor) increases the required yield strength, thus reducing ductility demand and related damage.

C11.5.2 Protected Access for Risk Category IV.

Those structures considered essential facilities for response and recovery efforts must be accessible to carry out their purpose. For example, if the collapse of a simple canopy at a hospital could block ambulances from the emergency room admittance area, then the canopy must meet the same structural standard as the hospital. The protected access requirement must be considered in the siting of essential facilities in densely built urban areas.

C11.6 SEISMIC DESIGN CATEGORY

Seismic Design Categories (SDCs) provide a means to step progressively from simple, easily performed design and construction procedures and minimums to more sophisticated, detailed, and costly requirements as both the level of seismic hazard and the consequence of failure escalate. The SDCs are used to trigger requirements that are not scalable; such requirements are either on or off. For example, the basic amplitude of ground motion for design is scalable—the quantity simply increases in a continuous fashion as one moves from a low hazard area to a high hazard area. However, a requirement to avoid weak stories is not particularly scalable. Requirements such as this create step functions. There are many such requirements in the standard, and the SDCs are used systematically to group these step functions. (Further examples include whether seismic anchorage of nonstructural components is required or not, whether particular inspections will be required or not, and structural height limits applied to various seismic force-resisting systems.)

In this regard, SDCs perform one of the functions of the seismic zones used in earlier U.S. building. However, SDCs also depend on a building's occupancy and, therefore, its desired performance. Furthermore, unlike the traditional implementation of seismic zones, the ground motions used to define the SDCs include the effects of individual site conditions on probable ground-shaking intensity.

In developing the ground-motion limits and design requirements for the various Seismic Design Categories, the equivalent modified Mercalli intensity (MMI) scale was considered. There are now correlations of the qualitative MMI scale with quantitative characterizations of ground motions. The reader is encouraged to consult any of a great many sources that describe the MMIs. The following list is a coarse generalization:

- MMI V No real damage
- MMI VI Light nonstructural damage
- MMI VII Hazardous nonstructural damage
- MMI VIII Hazardous damage to susceptible structures
- MMI IX Hazardous damage to robust structures

When the current design philosophy was adopted from the 1997 NEHRP provisions and Commentary (FEMA 1997a and FEMA 1997b), the upper limit for SDC A was set at roughly one-half of the lower threshold for MMI VII, and the lower limit for SDC D was set at roughly the lower threshold for MMI VIII. However, the lower limit for SDC D was more consciously established by equating that design value (two-thirds of the MCE) to one-half of what had been the maximum design value in building codes over the period of 1975 to 1995. As more correlations between MMI and numerical representations of ground motion have been created, it is reasonable to make the following correlation between the MMI at MCE ground motion and the Seismic Design Category (all this discussion is for ordinary occupancies):

- MMI V SDC A
- MMI VI SDC B

MMI VII SDC C

MMI VIII SDC D

MMI IX SDC E

An important change was made to the determination of SDC when the current design philosophy was adopted. Earlier editions of the *NEHRP Provisions* used the peak velocity-related acceleration, A_v , to determine a building's seismic performance category. However, this coefficient does not adequately represent the damage potential of earthquakes on sites with soil conditions other than rock. Consequently, the 1997 NEHRP provisions (FEMA 1997a) adopted the use of response spectral acceleration parameters S_{DS} and S_{D1} , which include site soil effects for this purpose.

Except for the lowest level of hazard (SDC A), the SDC also depends on the Risk Categories. For a given level of ground motion, the SDC is one category higher for Risk Category IV structures than for lower risk structures. This rating has the effect of increasing the confidence that the design and construction requirements can deliver the intended performance in the extreme event.

Note that the tables in the standard are at the design level, defined as two-thirds of the MCE level. Also recall that the MMIs are qualitative by their nature and that the above correlation will be more or less valid, depending on which numerical correlation for MMI is used. The numerical correlations for MMI roughly double with each step, so correlation between design earthquake ground motion and MMI is not as simple or convenient.

In sum, at the MCE level, SDC A structures should not see motions that are normally destructive to structural systems, whereas the MCE level motions for SDC D structures can destroy vulnerable structures. The grouping of step function requirements by SDC is such that there are a few basic structural integrity requirements imposed at SDC A, graduating to a suite of requirements at SDC D based on observed performance in past earthquakes, analysis, and laboratory research.

The nature of ground motions within a few kilometers of a fault can be different from more distant motions. For example, some near-fault motions have strong velocity pulses, associated with forward rupture directivity, that tend to be highly destructive to irregular structures, even if they are well detailed. For ordinary occupancies, the boundary between SDCs D and E is set to define sites likely to be close enough to a fault that these unusual ground motions may be present. Note that this boundary is defined in terms of mapped bedrock outcrop motions affecting response at 1 s, not site-adjusted values, to better discriminate between sites near and far from faults. Short-period response is not normally as affected as the longer period response. The additional design criteria imposed on structures in SDCs E and F specifically are intended to provide acceptable performance under these very intense near-fault ground motions.

For most buildings, the SDC is determined without consideration of the building's period. Structures are assigned to an SDC based on the more severe condition determined from 1-s acceleration and short-period acceleration. This assigning is done for several reasons. Perhaps the most important of these is that it is often difficult to estimate precisely the period of a structure using default procedures contained in the standard. Consider, for example, the case of rigid wall–flexible diaphragm buildings, including low-rise reinforced masonry and concrete tilt-up buildings with either untopped metal deck or wood diaphragms. The formula in the standard for determining the period of vibration of such buildings is based solely on the structural height, H , and the length of wall present. These formulas typically indicate very short periods for such structures, often on the order of 0.2 s or less. However, the actual dynamic behavior of these buildings often is dominated by the flexibility of the diaphragm—a factor neglected by the formula for approximate fundamental period. Large buildings of this type can have actual periods on the order of 1 s or more. To avoid misclassifying a building's SDC by inaccurately estimating the fundamental period, the

standard generally requires that the more severe SDC determined on the basis of short- and long-period shaking be used.

Another reason for this requirement is a desire to simplify building regulation by requiring all buildings on a given soil profile in a particular region to be assigned to the same SDC, regardless of the structural type. This assignment has the advantage of permitting uniform regulation in the selection of seismic force-resisting systems, inspection and testing requirements, seismic design requirements for nonstructural components, and similar aspects of the design process regulated on the basis of SDC, within a community.

Notwithstanding the above, it is recognized that classification of a building as SDC C instead of B or D can have a significant impact on the cost of construction. Therefore, the standard includes an exception permitting the classification of buildings that can reliably be classified as having short structural periods on the basis of short-period shaking alone.

Local or regional jurisdictions enforcing building regulations may desire to consider the effect of the maps, typical soil conditions, and Seismic Design Categories on the practices in their jurisdictional areas. For reasons of uniformity of practice or reduction of potential errors, adopting ordinances could stipulate particular values of ground motion, particular site classes, or particular Seismic Design Categories for all or part of the area of their jurisdiction. For example,

1. An area with a historical practice of high seismic zone detailing might mandate a minimum SDC of D regardless of ground motion or site class.
2. A jurisdiction with low variation in ground motion across the area might stipulate particular values of ground motion rather than requiring the use of maps.
3. An area with unusual soils might require use of a particular site class unless a geotechnical investigation proves a better site class.

C11.7 DESIGN REQUIREMENTS FOR SEISMIC DESIGN CATEGORY A

The 2002 edition of the standard included a new provision of minimum lateral force for Seismic Design Category A structures. The minimum load is a structural integrity issue related to the load path. It is intended to specify design forces in excess of wind loads in heavy low-rise construction. The design calculation in Section 1.4.2 of the standard is simple and easily done to ascertain if the seismic load or the wind load governs. This provision requires a minimum lateral force of 1% of the total gravity load assigned to a story to ensure general structural integrity.

Seismic Design Category A is assigned when the MCE ground motions are below those normally associated with hazardous damage. Damaging earthquakes are not unknown or impossible in such regions, however, and ground motions close to such events may be large enough to produce serious damage. Providing a minimum level of resistance reduces both the radius over which the ground motion exceeds structural capacities and resulting damage in such rare events. There are reasons beyond seismic risk for minimum levels of structural integrity.

The requirements for SDC A in Section 1.4 are all minimum strengths for structural elements stated as forces at the level appropriate for direct use in the strength design load combinations of Section 2.3. The two fundamental requirements are a minimum strength for a structural system to resist lateral forces (Section 1.4.2) and a minimum strength for connections of structural members (Section 1.4.3).

For many buildings, the wind force controls the strength of the lateral-force-resisting system, but for low-rise buildings of heavy construction with large plan aspect ratios, the minimum lateral force specified in Section 1.4.2 may control. Note that the requirement is for strength and not for toughness, energy-dissipation capacity, or some measure of ductility. The force level is not tied to any postulated seismic ground motion. The boundary between SDCs A and B is based on a spectral response acceleration of 25% of gravity (MCE level) for short-period structures; clearly the 1% acceleration level (from Eq. (1.4-1)) is far smaller. For ground motions below the A/B boundary, the spectral displacements generally are on the

order of a few inches or less depending on period. Experience has shown that even a minimal strength is beneficial in providing resistance to small ground motions, and it is an easy provision to implement in design. The low probability of motions greater than the MCE is a factor in taking the simple approach without requiring details that would produce a ductile response. Another factor is that larger design forces are specified in Section 1.4.3 for connections between main elements of the lateral force load path.

The minimum connection force is specified in three ways: a general minimum horizontal capacity for all connections; a special minimum for horizontal restraint of in-line beams and trusses, which also includes the live load on the member; and a special minimum for horizontal restraint of concrete and masonry walls perpendicular to their plane (Section 1.4.4). The 5% coefficient used for the first two is a simple and convenient value that provides some margin over the minimum strength of the system as a whole.

C11.8 GEOLOGIC HAZARDS AND GEOTECHNICAL INVESTIGATION

In addition to this commentary, Part 3 of the 2009 NEHRP recommended provisions (FEMA 2009) includes additional and more detailed discussion and guidance on evaluation of geologic hazards and determination of seismic lateral pressures.

C11.8.1 Site Limitation for Seismic Design Categories E and F.

Because of the difficulty of designing a structure for the direct shearing displacement of fault rupture and the relatively high seismic activity of SDCs E and F, locating a structure on an active fault that has the potential to cause rupture of the ground surface at the structure is prohibited.

C11.8.2 Geotechnical Investigation Report Requirements for Seismic Design Categories C through F.

Earthquake motion is only one factor in assessing potential for geologic and seismic hazards. All of the listed hazards can lead to surface ground displacements with potential adverse consequences to structures. Finally, hazard identification alone has little value unless mitigation options are also identified.

C11.8.3 Additional Geotechnical Investigation Report Requirements for Seismic Design Categories D through F.

Provisions for computing peak ground acceleration for soil liquefaction and stability evaluations were introduced in this section in ASCE 7-10. Of particular note in this section is the explicitly stated requirement that liquefaction must now be evaluated for maximum considered earthquake geometric mean (MCE_G) peak ground acceleration (PGA_M) where the parameter PGA_M includes site effects. Values of the parameter PGA_M are archived in the USGS Seismic Design Geodatabase at gridded locations across United States regions of interest. Values are provided online by the USGS Seismic Design Web Service for user-specified site location (i.e., latitude and longitude) and site class, by spatially interpolating between the gridded values of PGA_M based on site location. Mapped values of PGA_M are provided in Chapter 22 for default site conditions.

PGA Provisions. Item 2 of Section 11.8.3 states that peak ground acceleration shall be determined based on either a site-specific study, taking into account soil amplification effects, or from the USGS Seismic Design Geodatabase via the USGS Seismic Design Web Service for the site location and site class of interest. This methodology for determining peak ground acceleration for liquefaction provides an alternative to conducting site response analysis using rock PGA by providing a site-adjusted ground surface acceleration (PGA_M) that can directly be applied in the widely used empirical correlations for assessing liquefaction potential. Correlations for evaluating liquefaction potential are elaborated on in Resource Paper RP 12, "Evaluation of Geologic Hazards and Determination of Seismic Lateral Earth Pressures," published in the 2009 NEHRP provisions (FEMA 2009).

There is an important difference in the derivation of the PGA maps and the maps of S_s and S_1 in ASCE 7-10. Unlike previous editions of ASCE 7, the S_s and S_1 maps in ASCE 7-10 were derived for the “maximum direction shaking” and are risk based rather than hazard based. However, the PGA maps have been derived based on the geometric mean of the two horizontal components of motion. The geometric mean was used in the PGA maps rather than the PGA for the maximum direction shaking to ensure that there is consistency between the determination of PGA and the basis of the simplified empirical field procedure for estimating liquefaction potential based on results of standard penetration tests (SPTs), cone penetrometer tests (CPTs), and other similar field investigative methods. When these correlations were originally derived, the geomean (or a similar metric) of peak ground acceleration at the ground surface was used to identify the cyclic stress ratio for sites with or without liquefaction. The resulting envelopes of data define the liquefaction cyclic resistance ratio (CRR). Rather than reevaluating these case histories for the “maximum direction shaking,” it was decided to develop maps of the geomean PGA and to continue using the existing empirical methods.

Liquefaction Evaluation Requirements. Beginning with ASCE 7-02, it has been the intent that liquefaction potential be evaluated at MCE ground motion levels. There was ambiguity in the previous requirement in ASCE 7-05 as to whether liquefaction potential should be evaluated for the MCE or for the design earthquake. Paragraph 2 of Section 11.8.3 of ASCE 7-05 stated that liquefaction potential would be evaluated for the design earthquake; it also stated that in the absence of a site-specific study, peak ground acceleration shall be assumed to be equal to $S_s / 2.5$ (where S_s was the MCE short-period response spectral acceleration on Site Class B rock). There has also been a difference in provisions between ASCE 7-05 and the 2006 edition of the IBC, in which Section 1802.2.7 stated that liquefaction shall be evaluated for the design earthquake ground motions and the default value of peak ground acceleration in the absence of a site-specific study was given as $S_{DS} / 2.5$ (where S_{DS} was the short-period site-adjusted design response spectral acceleration on Site Class B rock). ASCE 7-10 and ASCE 7-16, in item 2 of Section 11.8.3 requires explicitly that liquefaction potential be evaluated based on the MCE_G peak ground acceleration.

The explicit requirement in ASCE 7-10 and ASCE 7-16 to evaluate liquefaction for MCE ground motion rather than to design earthquake ground motion ensures that the full potential for liquefaction is addressed during the evaluation of structure stability, rather than a lesser level when the design earthquake is used. This change also ensures that, for the MCE ground motion, the performance of the structure is considered under a consistent hazard level for the effects of liquefaction, such as collapse prevention or life safety, depending on the risk category for the structure (Figure C11.5-1). By evaluating liquefaction for the MCE rather than the design earthquake peak ground acceleration, the ground motion for the liquefaction assessment increases by a factor of 1.5. This increase in peak ground acceleration to the MCE level means that sites that previously were nonliquefiable could now be liquefiable, and sites where liquefaction occurred to a limited extent under the design earthquake could undergo more liquefaction, in terms of depth and lateral extent. Some mechanisms that are directly related to the development of liquefaction, such as lateral spreading and flow or ground settlement, could also increase in severity.

This change in peak ground acceleration level for the liquefaction evaluation addressed an issue that has existed and has periodically been discussed since the design earthquake concept was first suggested in the 1990s. The design earthquake ground motion was obtained by multiplying the MCE ground motion by a factor of $2/3$ to account for a margin in capacity in most buildings. Various calibration studies at the time of code development concluded that for the design earthquake, most buildings had a reserve capacity of more than 1.5 relative to collapse. This reserve capacity allowed the spectral accelerations for the MCE to be reduced using a factor of $2/3$, while still achieving safety from collapse. However, liquefaction potential is evaluated at the selected MCE_G peak ground acceleration and is typically determined to be acceptable if the factor of safety is greater than 1.0, meaning that there is no implicit safety margin on liquefaction potential. By multiplying peak ground acceleration by a factor of $2/3$, liquefaction would be assessed at an

effective return period or probability of exceedance different than that for the MCE. However, ASCE 7-10 requires that liquefaction be evaluated for the MCE.

Item 3 of Section 11.8.3 of ASCE 7-10 and ASCE 7-16 lists the various potential consequences of liquefaction that must be assessed; soil downdrag and loss in lateral soil reaction for pile foundations are additional consequences that have been included in this paragraph. This section of the new provisions, as in previous editions, does not present specific seismic criteria for the design of the foundation or substructure, but item 4 does state that the geotechnical report must include discussion of possible measures to mitigate these consequences.

A liquefaction resource document has been prepared in support of these revisions to Section 11.8.3. The resource document “Evaluation of Geologic Hazards and Determination of Seismic Lateral Earth Pressures,” includes a summary of methods that are currently being used to evaluate liquefaction potential and the limitations of these methods. This summary appears as Resource Paper RP 12 in the 2009 NEHRP provisions (FEMA 2009). The resource document summarizes alternatives for evaluating liquefaction potential, methods for evaluating the possible consequences of liquefaction (e.g., loss of ground support and increased lateral earth pressures) and methods of mitigating the liquefaction hazard. The resource document also identifies alternate methods of evaluating liquefaction hazards, such as analytical and physical modeling. Reference is made to the use of nonlinear effective stress methods for modeling the buildup in pore water pressure during seismic events at liquefiable sites.

Evaluation of Dynamic Seismic Lateral Earth Pressures. The dynamic lateral earth pressure on basement and retaining walls during earthquake ground shaking is considered to be an earthquake load, E , for use in design load combinations. This dynamic earth pressure is superimposed on the preexisting static lateral earth pressure during ground shaking. The preexisting static lateral earth pressure is considered to be an H load.

C11.9 VERTICAL GROUND MOTIONS FOR SEISMIC DESIGN

C11.9.1 General

The guidelines for developing vertical spectra apply in the western U.S. because that is the main region for which models for vertical-component response spectra are available. The boundary line of -105 degrees longitude comes from the approximate eastern limit of ground motion models for active tectonic regions as given in Figure 1.1 of Goulet et al. (2017). The states of Alaska and Hawaii, as well as other non-conterminous United States sites, are assumed to be more similar to the western United States than central and eastern United States for the purpose of applying the provisions in Section 11.9.

A prior recommendation for developing vertical spectra in the central and eastern U.S. was presented by EPRI (2015; their Appendix A); those recommendations apply to relatively old versions of western U.S. models for application in the east. Since the application of western models in the central and eastern U.S. has not been demonstrated, a simple two-thirds rule is suggested in lieu of the more complex model in these guidelines.

C11.9.2 MCE_R Vertical Response Spectrum

Recent studies of horizontal and vertical ground motions (e.g., Bozorgnia and Campbell 2004, Bozorgnia and Campbell 2016a,b; Gülerce et al. 2017; Stewart et al. 2016) have shown that vertical ground motion is different from horizontal motion in several important respects: (1) vertical ground motion has a larger proportion of short-period (high-frequency) spectral content than horizontal ground motion, and this difference increases with decreasing soil stiffness, (2) vertical ground motion attenuates at a higher rate than horizontal ground motion, and this difference increases with decreasing distance from the earthquake, and (3) the nonlinear component of site response is stronger in the horizontal component than in the vertical component, which causes vertical/horizontal (V/H) spectral ratios to exceed unity for soil sites at close distance to large faults where nonlinear effects are significant. The observed differences in the spectral

content, attenuation rate, and site response of vertical and horizontal ground motion lead to the following observations regarding the vertical/horizontal V/H spectral ratio:

1. The V/H spectral ratio is sensitive to spectral period, distance from the earthquake, local site conditions, and earthquake magnitude and is insensitive to earthquake mechanism and sediment depth;
2. The V/H spectral ratio has a distinct peak at short periods that generally exceeds two-thirds in the near-source region of an earthquake; and
3. The V/H spectral ratio is generally less than two-thirds at mid-to-long periods.

The procedure for defining the MCE_R vertical response spectrum is keyed to the multi-period MCE_R spectral response acceleration parameter at short periods, S_{aM} . The procedure is based on the studies of horizontal and vertical ground motions conducted by Campbell and Bozorgnia (2003), Bozorgnia and Campbell (2004), and a series of models generated in the NGA-West2 project (Bozorgnia and Campbell 2016a,b; Gülerce et al. 2017; Stewart et al. 2016).

The specification of vertical ground motions in Section 11.9.2 is based on the product of the multi-period risk-targeted maximum considered earthquake ground motion (S_{aM}) and a simplified representation of the vertical/horizontal spectral ratio (V/H) that has five regions defined by the fundamental vertical period of vibration (T_v). Based on the study of Bozorgnia and Campbell (2004), the periods that define these regions are approximately constant with respect to the magnitude of the earthquake, the distance from the earthquake, and the local site conditions.

The horizontal MCE_R is based on maximum direction parameters, so it must be converted back to the median component to be consistent with the studies referenced above. The NGA-West2 models used median-component horizontal spectral parameters to compute the ratio of vertical to horizontal. To reduce the S_{aM} from the maximum direction to the median-component, S_{aM} is divided by factor, F_{md} (Equations 11.9-6 to 11.9-8). Those F_{md} factors are consistent with commentary of Chapter 21, Resource Paper 4 of the 2015 Provisions, and Shahi and Baker (2014).

The equations in Section 11.9.2 that are used to define the design vertical response spectrum are based on four considerations (adapted from Bozorgnia and Campbell 2004):

1. The short-period part of the 5% damped vertical response spectrum is controlled by the spectral acceleration at $T_v = 0.1$ s;
2. The mid-period part of the vertical response spectrum is controlled by a spectral acceleration that decays as the inverse of a power of the vertical period of vibration. This was taken as $T_v^{-0.75}$ in the 2009 NEHRP Provisions and has been updated to $T_v^{-0.5}$;
3. The short-period part of the V/H spectral ratio is a function of the local site conditions (i.e. V_{S30}) and the level of seismic demand (represented in Table 11.9-1 by parameter S_{MS}); and
4. For vertical vibration periods $T_v >$ about 0.3 to 0.5 sec, V/H spectral ratios saturate to values typically less than 0.5 that are relatively consistent with respect to period across this period range. For simplicity, V/H spectral ratios are taken as 0.5 in this range of periods.

The following description of the detailed procedure listed in Section 11.9.2 refers to the illustrated MCE_R V/H response spectral ratio plot in Figure C11.9-1.

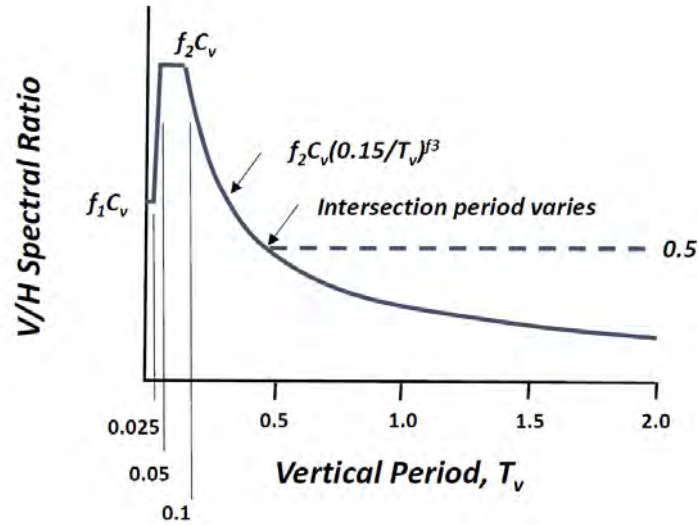

FIGURE C11.9-1 Illustrative Example of the Vertical/Horizontal Spectral Ratio

Vertical Periods Less Than or Equal to 0.025 s. Eq. (11.9-1) defines that part of the MCE_R vertical response spectrum that is controlled by the vertical peak ground acceleration. The f_1 factor (taken as 0.65) was selected to approximately match V/H ordinates from recent NGA-West2 models for soil site classes (it is somewhat unconservative in this period range for rock sites). The vertical coefficient, C_v , in Table 11.9-1 accounts for the site dependence of V/H ordinates.

Vertical Periods Greater Than 0.025 s and Less Than or Equal to 0.05 s. Eq. (11.9-2) defines that part of the MCE_R vertical response spectrum for which the V/H spectral ratio linearly transitions from the part that is controlled by the vertical peak ground acceleration to the part that is controlled by the dynamically amplified short-period spectral plateau. The factor of 16 is required to provide appropriate levels of amplification at the peak of the V/H spectral ratio plot.

Vertical Periods Greater Than 0.05 s and Less Than or Equal to 0.1 s. Eq. (11.9-3) defines that part of the MCE_R vertical response spectrum for which the V/H spectral ratio is dynamically amplified to a short-period plateau at amplitude f_2 in Figure C11.9-1. The width of the peak from 0.05 to 0.1 s is best suited to soil sites (Classes C to DE), being conservative for rock sites (Classes BC to A).

Vertical Periods Greater Than 0.1 s and Less Than or Equal to 2.0 s. Eq. (11.9-4) defines that part of the MCE_R vertical response spectrum for which the V/H spectral ratio decays with the inverse of the vertical period of vibration raised to the $-f_3$ power (currently taken as -0.5 , formerly -0.75). This portion of the spectrum was constructed in a generally conservative manner, as two of the three NGA-West2 models suggest the period range of post-peak decay is steeper than implied by the -0.5 power, with approximately flat V/H ratios at periods longer than about 0.3 to 0.5 sec. The flat V/H ratios at periods beyond 0.3-0.5 sec are typically less than 0.5, and a limiting value of 0.5 is suggested in the absence of site-specific analysis. This limit of 0.5 is considered a reasonable, but somewhat conservative, lower bound (Campbell and Bozorgnia 2003 and Bozorgnia and Campbell 2004).

Vertical Periods Greater Than 2.0 s and Less Than or Equal to 10.0 s. Eq. (11.9-5) defines that part of the MCE_R vertical response spectrum for which the V/H spectral ratio is roughly constant. A recommended lower limit of 0.5 is provided for this range.

REFERENCES

- ASCE. (2014). “Seismic evaluation and retrofit of existing buildings.” *ASCE/SEI 41-13* . Reston, VA.
- Bozorgnia, Y., and Campbell, K. W. (2004). “The vertical-to-horizontal response spectral ratio and tentative procedures for developing simplified V/H and vertical design spectra.” *J. Earthq. Eng.*, 8, 175–207.
- Bozorgnia, Y and KW Campbell (2016a). “Vertical ground motion model for pga, pgv, and linear response spectra using the nga-west2 database.” *Earthquake Spectra*, 32, 979-1004.
- Bozorgnia, Y and KW Campbell (2016b). “Ground motion model for the vertical-to-horizontal (v/h) ratios of pga, pgv, and response spectra.” *Earthquake Spectra*, 32, 951-978.
- Campbell, K. W., and Bozorgnia, Y. (2003). “Updated near-source ground motion (attenuation) relations for the horizontal and vertical components of peak ground acceleration and acceleration response spectra.” *Bull. Seismol. Society of Am.*, 93, 314–331.
- Crouse, C. B., Leyendecker, E. V., Somerville, P. G., Power, M., and Silva, W. J. (2006). *Development of seismic ground-motion criteria for the ASCE/SEI 7 standard*, Paper 533. Proc. 8th U.S. National Conference on Earthquake Engineering .
- Electric Power Research Institute, EPRI (2015), “High frequency program, application guidance for functional confirmation and fragility evaluation,” *Technical Report 3002004396*, July 2015.
- Elnashai, A. S . (1997). “Seismic design with vertical earthquake motion.” Seismic design for the next generation of codes, P. Fajfar, and H. Krawinkler, eds., Balkema, Rotterdam, *Netherlands*, 91–100.
- Executive Order 12699. (2016). *Establishing a Federal Earthquake Risk Management Standard*. <http://www.whitehouse.gov/the-press-office/2016/02/02/executive-order-establishing-federal-earthquake-risk-management-standard>.
- Federal Emergency Management Agency (FEMA). (1997a). “NEHRP recommended provisions for seismic regulations in new buildings and other structures.” *FEMA 302*. Washington, DC.
- FEMA. (1997b). “NEHRP recommended provisions for seismic regulations in new buildings and other structures: Part 2, commentary.” *FEMA 303* . Washington, DC.
- FEMA. (2009). “NEHRP recommended seismic provisions for new buildings and other structures.” *FEMA P-750* . Washington, DC.
- FEMA. (2020). “Procedures for developing multi-period response spectra at non-conterminous united states sites.” *FEMA P-2078*, Washington, D.C.
- Goulet, CA, Y Bozorgnia, N Kuehn, L Al Atik, RR Youngs, RW Graves, and GM Atkinson (2017). *NGA-East ground-motion models for the U.S. Geological Survey National Seismic Hazard Maps*, PEER Report 2017/03, Pacific Earthquake Engineering Research Center, Berkeley, CA.
- Gülerce, Z, R Kamai, NA Abrahamson, and WJ Silva (2017). “Ground motion prediction equations for the vertical ground motion component based on the nga-w2 database.” *Earthquake Spectra*, 33, 499-528.
- International Conference of Building Officials (ICBO). (1997). *Uniform building code* . Whittier, CA.
- Kircher & Associates. (2015). *Investigation of an identified shortcoming in the seismic design procedures of ASCE 7-10 and development of recommended improvements for ASCE 7-16*. Prepared for Building Seismic Safety Council, National Institute of Building Sciences, Washington, DC, Palo Alto, CA (https://c.ymcdn.com/sites/www.nibs.org/resource/resmgr/BSSC2/Seismic_Factor_Study.pdf).

- NIBS (2019). *BSSC Project 17 Final Report-Development of next generation of seismic design value maps for the 2020 NEHRP Provisions*, Building Seismic Safety Council, National Institute of Building Sciences, Washington, D.C.
- Shahi, SK and JW Baker (2014). “NGA-West2 models for ground motion directionality.” *Earthquake Spectra*, 30, 1285-1300.
- Silva, W. (1997). “Characteristics of vertical strong ground motions for applications to engineering design. FHWA/NCEER workshop on the national representation of seismic ground motion for new and existing highway facilities.” *Technical Report NCEER-97-0010*, National Center for Earthquake Engineering Research, Buffalo, NY.
- Stewart, JP, DM Boore, E Seyhan, and GM Atkinson (2016). “NGA-West2 equations for predicting vertical-component PGA, PGV, and 5%-damped PSA from Shallow Crustal Earthquakes.” *Earthquake Spectra*, 32, 1005-1031.
- Structural Engineers Association of California (SEAOC). (1999). *Recommended lateral force requirements and commentary*, Seismology Committee, Sacramento, CA.

OTHER REFERENCES (NOT CITED)

- Abrahamson, N. A. (2000). “Effects of rupture directivity on probabilistic seismic hazard analysis.” *Proc. 6th Intl. Conference on Seismic Zonation*, Palm Springs, CA.
- ASCE. (2017). “Seismic rehabilitation of existing buildings.” *ASCE/SEI 41-06*. Reston, VA.
- Borcherdt, R. D. (2002). “Empirical evidence for site coefficients in building-code provisions.” *Earthq. Spectra*, 18(2), 189–217.
- Crouse, C. B., and McGuire, J. W. (1996). “Site response studies for purposes of revising NEHRP seismic provisions.” *Earthq. Spectra*, 12(3), 129–143.
- Dobry, R., Ramos, R., and Power, M. S. (1999). “Site factors and site categories in seismic codes.” *Technical Report MCEER-99-0010*. Multidisciplinary Center for Earthquake Engineering Research, University of Buffalo, NY.
- Field, E. H. (2000). “A modified ground motion attenuation relationship for Southern California that accounts for detailed site classification and a basin depth effect.” *Bull. Seismol. Soc. of Am.*, 90, S209–S221.
- Harmsen, S. C. (1997). “Determination of site amplification in the Los Angeles urban area from inversion of strong motion records.” *Bull. Seismol. Soc. of Am.*, 87, 866–887.
- Huang, Y.-N., Whittaker, A. S., and Luco, N. (2008). “Orientation of maximum spectral demand in the near-fault region.” *Earthq. Spectra*, 24, 319–341.
- Joyner, W. B., and Boore, D. M. (2000). *Recent developments in earthquake ground motion estimation*. Proc. 6th Intl. Conference on Seismic Zonation, Palm Springs, CA.
- Luco, N., Ellingwood, B. R., Hamburger, R. O., Hooper, J. D., Kimball, J. K., and Kircher, C. A. (2007). *Risk-targeted vs. current seismic design maps for the conterminous United States*. Proc. SEAOC 76th Annual Convention, Sacramento, CA.
- Petersen, M. D., Frankel, A. D., Harmsen, S. C., Mueller, C. S., Haller, K. M., Wheeler, R. L., et al. (2008). “Documentation for the 2008 update of the United States national seismic hazard maps.” *USGS Open File Report 2008-1128*, U.S. Geological Survey, Reston, VA.
- Rodriguez-Marek, A., Bray, J. D., and Abrahamson, N. (2001). “An empirical geotechnical site response procedure.” *Earthq. Spectra*, 17(1), 65–87.

- Seyhan, E. (2014). *Weighted average of 2014 NGA West-2 GMPEs*, Excel file: NGAW2_GMPE_Spreadsheets_v5.6_070514, Pacific Earthquake Engineering Center, Berkeley, CA (<http://peer.berkeley.edu/ngawest2/databases/>).
- Silva, W., Darragh, R., Gregor, N., Martin, G., Abrahamson, N., and Kircher, C. (2000). *Reassessment of site coefficients and near-fault factors for building code provisions*. Building Code Provisions, Program Element II, *Report 98-HQ-GR-1010*, U.S. Geological Survey, Reston, VA.
- Somerville, P. G., Smith, N. F., Graves, R. W., and Abrahamson, N. A. (1997). "Modification of empirical strong ground motion attenuation relations to include the amplitude and duration effects of rupture directivity." *Seismol. Res. Lett.*, 68, 199–222.
- Steidl, J. H. (2000). "Site response in Southern California for probabilistic seismic hazard analysis." *Bull. Seismol. Soc. of Am.*, 90, S149–S169.
- Stewart, J. P., Liu, A. H., and Choi, Y. (2003). "Amplification factors for spectral acceleration in tectonically active regions." *Bull. Seismol. Soc. of Am.*, 93(1), 332–352.

COMMENTARY TO CHAPTER 12, SEISMIC DESIGN REQUIREMENTS FOR BUILDING STRUCTURES

C12.1 STRUCTURAL DESIGN BASIS

The performance expectations for structures designed in accordance with this standard are described in Sections C11.1 and C11.5. Structures designed in accordance with the standard are likely to have a low probability of collapse but may suffer serious structural damage if subjected to the risk-targeted maximum considered earthquake (MCE_R) or stronger ground motion.

Although the seismic requirements of the standard are stated in terms of forces and loads, there are no external forces applied to the structure during an earthquake as, for example, is the case during a windstorm. The design forces are intended only as approximations to generate internal forces suitable for proportioning the strength and stiffness of structural elements and for estimating the deformations (when multiplied by the deflection amplification factor, C_d) that would occur in the same structure in the event of design earthquake (not MCE_R) ground motion.

C12.1.1 Basic Requirements.

Chapter 12 of the standard sets forth a set of coordinated requirements that must be used together. The basic steps in structural design of a building structure for acceptable seismic performance are as follows:

1. Select gravity- and seismic force-resisting systems appropriate to the anticipated intensity of ground shaking. Section 12.2 sets forth limitations depending on the Seismic Design Category.
2. ConFigure these systems to produce a continuous, regular, and redundant load path so that the structure acts as an integral unit in responding to ground shaking. Section 12.3 addresses configuration and redundancy issues.
3. Analyze a mathematical model of the structure subjected to lateral seismic motions and gravity forces. Sections 12.6 and 12.7 set forth requirements for the method of analysis and for construction of the mathematical model. Sections 12.5, 12.8, and 12.9 set forth requirements for conducting a structural analysis to obtain internal forces and displacements.
4. Proportion members and connections to have adequate lateral and vertical strength and stiffness. Section 12.4 specifies how the effects of gravity and seismic loads are to be combined to establish required strengths, and Section 12.12 specifies deformation limits for the structure.

One- to three-story structures with shear wall or braced frame systems of simple configuration may be eligible for design under the simplified alternative procedure contained in Section 12.14. Any other deviations from the requirements of Chapter 12 are subject to approval by the authority having jurisdiction (AHJ) and must be rigorously justified, as specified in Section 11.1.4.

The baseline seismic forces used for proportioning structural elements (individual members, connections, and supports) are static horizontal forces derived from an elastic response spectrum procedure. A basic requirement is that horizontal motion can come from any direction relative to the structure, with detailed requirements for evaluating the response of the structure provided in Section 12.5. For most structures, the effect of vertical ground motions is not analyzed explicitly; it is implicitly included by adjusting the load factors (up and down) for permanent dead loads, as specified in Section 12.4. Certain conditions requiring more detailed analysis of vertical response are defined in Chapters 13 and 15 for nonstructural components and nonbuilding structures, respectively.

The basic seismic analysis procedure uses response spectra that are representative of, but substantially reduced from, the anticipated ground motions. As a result, at the MCE_R level of ground shaking, structural elements are expected to yield, buckle, or otherwise behave inelastically. This approach has substantial historical precedent. In past earthquakes, structures with appropriately ductile, regular, and continuous

systems that were designed using *reduced* design forces have performed acceptably. In the standard, such design forces are computed by dividing the forces that would be generated in a structure behaving elastically when subjected to the design earthquake ground motion by the response modification coefficient, R , and this design ground motion is taken as two-thirds of the MCE_R ground motion.

The intent of R is to reduce the demand determined, assuming that the structure remains elastic at the design earthquake, to target the development of the first significant yield. This reduction accounts for the displacement ductility demand, R_d , required by the system and the inherent overstrength, Ω , of the seismic force-resisting system (SFRS) (Figure C12.1-1). Significant yield is the point where complete plastification of a critical region of the SFRS first occurs (e.g., formation of the first plastic hinge in a moment frame), and the stiffness of the SFRS to further increases in lateral forces decreases as continued inelastic behavior spreads within the SFRS. This approach is consistent with member-level ultimate strength design practices. As such, first significant yield should not be misinterpreted as the point where first yield occurs in any member (e.g., 0.7 times the yield moment of a steel beam or either initial cracking or initiation of yielding in a reinforcing bar in a reinforced concrete beam or wall).

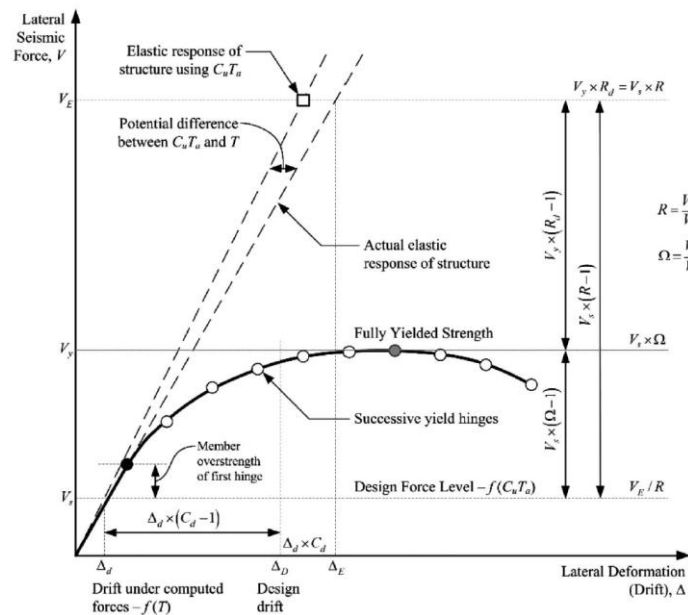

FIGURE C12.1-1 Inelastic Force–Deformation Curve

Figure C12.1-1 shows the lateral force versus deformation relation for an archetypal moment frame used as an SFRS. First significant yield is shown as the lowest plastic hinge on the force–deformation diagram. Because of particular design rules and limits, including material strengths in excess of nominal or project-specific design requirements, structural elements are stronger by some degree than the strength required by analysis. The SFRS is therefore expected to reach first significant yield for forces in excess of design forces. With increased lateral loading, additional plastic hinges form and the resistance increases at a reduced rate (following the solid curve) until the maximum strength is reached, representing a fully yielded system. The maximum strength developed along the curve is substantially higher than that at first significant yield, and this margin is referred to as the system overstrength capacity. The ratio of these strengths is denoted as Ω . Furthermore, the Figure illustrates the potential variation that can exist between the actual elastic response of a system and that considered using the limits on the fundamental period (assuming 100% mass participation in the fundamental mode—see Section C12.8.6). Although not a concern for strength design, this variation can have an effect on the expected drifts.

The system overstrength described above is the direct result of overstrength of the elements that form the SFRS and, to a lesser extent, the lateral force distribution used to evaluate the inelastic force–deformation curve. These two effects interact with applied gravity loads to produce sequential plastic hinges, as illustrated in the Figure. This member overstrength is the consequence of several sources. First, material overstrength (i.e., actual material strengths higher than the nominal material strengths specified in the design) may increase the member overstrength significantly. For example, a recent survey shows that the mean yield strength of ASTM A36 steel is about 30% to 40% higher than the specified yield strength used in design calculations. Second, member design strengths usually incorporate a strength reduction or resistance factor, ϕ , to produce a low probability of failure under design loading. It is common to not include this factor in the member load-deformation relation when evaluating the seismic response of a structure in a nonlinear structural analysis. Third, designers can introduce additional strength by selecting sections or specifying reinforcing patterns that exceed those required by the computations. Similar situations occur where prescriptive minimums of the standard, or of the referenced design standards, control the design. Finally, the design of many flexible structural systems (e.g., moment-resisting frames) can be controlled by the drift rather than strength, with sections selected to control lateral deformations rather than to provide the specified strength.

The result is that structures typically have a much higher lateral strength than that specified as the minimum by the standard, and the first significant yielding of structures may occur at lateral load levels that are 30% to 100% higher than the prescribed design seismic forces. If provided with adequate ductile detailing, redundancy, and regularity, full yielding of structures may occur at load levels that are two to four times the prescribed design force levels.

Most structural systems have some elements whose action cannot provide reliable inelastic response or energy dissipation. Similarly, some elements are required to remain essentially elastic to maintain the structural integrity of the structure (e.g., columns supporting a discontinuous SFRS). Such elements and actions must be protected from undesirable behavior by considering that the actual forces within the structure can be significantly larger than those at first significant yield. The standard specifies an overstrength factor, Ω_0 , to amplify the prescribed seismic forces for use in design of such elements and for such actions. This approach is a simplification to determining the maximum forces that could be developed in a system and the distribution of these forces within the structure. Thus, this specified overstrength factor is neither an upper nor a lower bound; it is simply an approximation specified to provide a nominal degree of protection against undesirable behavior.

The elastic deformations calculated under these reduced forces (*see* Section C12.8.6) are multiplied by the deflection amplification factor, C_d , to estimate the deformations likely to result from the design earthquake ground motion. This factor was first introduced in ATC 3-06 (ATC 1978). For a vast majority of systems, C_d is less than R , with a few notable exceptions, where inelastic drift is strongly coupled with an increased risk of collapse (e.g., reinforced concrete bearing walls). Research over the past 30 years has illustrated that inelastic displacements may be significantly greater than Δ_E for many structures and less than Δ_E for others. Where C_d is substantially less than R , the system is considered to have damping greater than the nominal 5% of critical damping. As set forth in Section 12.12 and Chapter 13, the amplified deformations are used to assess story drifts and to determine seismic demands on elements of the structure that are not part of the seismic force-resisting system and on nonstructural components within structures.

Figure C12.1-1 illustrates the significance of seismic design parameters contained in the standard, including the response modification coefficient, R ; the deflection amplification factor, C_d ; and the overstrength factor, Ω_0 . The values of these parameters, provided in Table 12.2-1, as well as the criteria for story drift and P-delta effects, have been established considering the characteristics of typical properly designed structures. The provisions of the standard anticipate an SFRS with redundant characteristics wherein

significant system strength above the level of first significant yield can be obtained by plastification at other critical locations in the structure before the formation of a collapse mechanism. If excessive “optimization” of a structural design is performed with lateral resistance provided by only a few elements, the successive yield hinge behavior depicted in Figure C12.1-1 is not able to form, the actual overstrength (Ω) is small, and use of the seismic design parameters in the standard may not provide the intended seismic performance.

The response modification coefficient, R , represents the ratio of the forces that would develop under the specified ground motion if the structure had an entirely linear-elastic response to the prescribed design forces (Figure C12.1-1). The structure must be designed so that the level of significant yield exceeds the prescribed design force. The ratio R_d , expressed as $R_d = V_E / V_S$, where V_E is the elastic seismic force demand and V_S is the prescribed seismic force demand, is always larger than 1.0; thus, all structures are designed for forces smaller than those the design ground motion would produce in a structure with a completely linear-elastic response. This reduction is possible for a number of reasons. As the structure begins to yield and deform inelastically, the effective period of response of the structure lengthens, which results in a reduction in strength demand for most structures. Furthermore, the inelastic action results in a significant amount of energy dissipation (hysteretic damping) in addition to other sources of damping present below significant yield. The combined effect, which is known as the ductility reduction, explains why a properly designed structure with a fully yielded strength (V_y in Figure C12.1-1) that is significantly lower than V_E can be capable of providing satisfactory performance under the design ground motion excitations.

The energy dissipation resulting from hysteretic behavior can be measured as the area enclosed by the force–deformation curve of the structure as it experiences several cycles of excitation. Some structures have far more energy dissipation capacity than others. The extent of energy dissipation capacity available depends largely on the amount of stiffness and strength degradation the structure undergoes as it experiences repeated cycles of inelastic deformation. Figure C12.1-2 shows representative load deformation curves for two simple substructures, such as a beam–column assembly in a frame. Hysteretic curve (a) in the Figure represents the behavior of substructures that have been detailed for ductile behavior. The substructure can maintain almost all of its strength and stiffness over several large cycles of inelastic deformation. The resulting force–deformation “loops” are quite wide and open, resulting in a large amount of energy dissipation. Hysteretic curve (b) represents the behavior of a substructure that has much less energy dissipation than that for the substructure (a) but has a greater change in response period. The structural response is determined by a combination of energy dissipation and period modification.

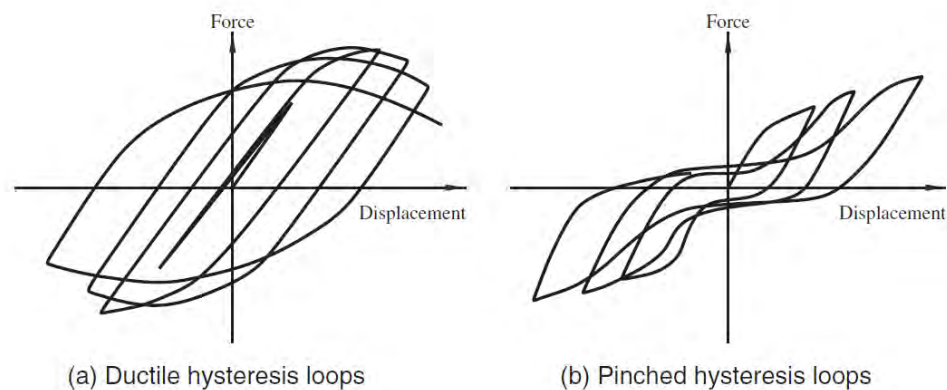

FIGURE C12.1-2 Typical Hysteretic Curves

The principles of this section outline the conceptual intent behind the seismic design parameters used by the standard. However, these parameters are based largely on engineering judgment of the various materials and performance of structural systems in past earthquakes and cannot be directly computed using the relationships presented in Figure C12.1-1. The seismic design parameters chosen for a specific project or system should be chosen with care. For example, lower values should be used for structures possessing a low degree of redundancy wherein all the plastic hinges required for the formation of a mechanism may be formed essentially simultaneously and at a force level close to the specified design strength. This situation can result in considerably more detrimental P-delta effects. Because it is difficult for individual designers to judge the extent to which the value of R should be adjusted based on the inherent redundancy of their designs, Section 12.3.4 provides the redundancy factor, ρ , that is typically determined by being based on the removal of individual seismic force-resisting elements.

Higher order seismic analyses are permitted for any structure and are required for some structures (*see* Section 12.6); lower limits based on the equivalent lateral force procedure may, however, still apply.

C12.1.2 Member Design, Connection Design, and Deformation Limit.

Given that key elements of the seismic force-resisting system are likely to yield in response to ground motions, as discussed in Section C12.1.1, it might be expected that structural connections would be required to develop the strength of connected members. Although that is a logical procedure, it is not a general requirement. The actual requirement varies by system and generally is specified in the standards for design of the various structural materials cited by reference in Chapter 14. Good seismic design requires careful consideration of this issue.

C12.1.3 Continuous Load Path and Interconnection.

In effect, Section 12.1.3 calls for the seismic design to be complete and in accordance with the principles of structural mechanics. The loads must be transferred rationally from their point of origin to the final point of resistance. This requirement should be obvious, but it often is overlooked by those inexperienced in earthquake engineering. Design consideration should be given to potentially adverse effects where there is a lack of redundancy. Given the many unknowns and uncertainties in the magnitude and characteristics of earthquake loading, in the materials and systems of construction for resisting earthquake loadings, and in the methods of analysis, good earthquake engineering practice has been to provide as much redundancy as possible in the seismic force-resisting system of buildings. Redundancy plays an important role in determining the ability of the building to resist earthquake forces. In a structural system without redundant elements, every element must remain operative to preserve the integrity of the building structure. However, in a highly redundant system, one or more redundant elements may fail and still leave a structural system that retains its integrity and can continue to resist lateral forces, albeit with diminished effectiveness.

Although a redundancy requirement is included in Section 12.3.4, overall system redundancy can be improved by making all joints of the vertical load-carrying frame moment resisting and incorporating them into the seismic force-resisting system. These multiple points of resistance can prevent a catastrophic collapse caused by distress or failure of a member or joint. (The overstrength characteristics of this type of frame are discussed in Section C12.1.1.)

The minimum connection forces are not intended to be applied simultaneously to the entire seismic force-resisting system.

C12.1.4 Connection to Supports.

The requirement is similar to that given in Section 1.4 on connections to supports for general structural integrity. See Section C1.4.

C12.1.5 Foundation Design.

Most foundation design criteria are still stated in terms of allowable stresses, and the forces computed in the standard are all based on the strength level of response. When developing strength-based criteria for foundations, all the factors cited in Section 12.1.5 require careful consideration. Section C12.13 provides specific guidance.

C12.1.6 Material Design and Detailing Requirements.

The design limit state for resistance to an earthquake is unlike that for any other load within the scope of the standard. The earthquake limit state is based on overall system performance, not member performance, where repeated cycles of inelastic straining are accepted as an energy-dissipating mechanism. Provisions that modify customary requirements for proportioning and detailing structural members and systems are provided to produce the desired performance.

C12.2 STRUCTURAL SYSTEM SELECTION

C12.2.1 Seismic Force-Resisting System Selection and Limitations.

For the purpose of seismic analysis and design requirements, seismic force-resisting systems are grouped into categories as shown in Table 12.2-1. These categories are subdivided further for various types of vertical elements used to resist seismic forces. In addition, the sections for detailing requirements are specified.

Specification of response modification coefficients, R , requires considerable judgment based on knowledge of actual earthquake performance and research studies. The coefficients and factors in Table 12.2-1 continue to be reviewed in light of recent research results. The values of R for the various systems were selected considering observed performance during past earthquakes, the toughness (ability to dissipate energy without serious degradation) of the system, and the amount of damping typically present in the system when it undergoes inelastic response. FEMA P-695 (2009b) has been developed with the purpose of establishing and documenting a methodology for quantifying seismic force-resisting system performance and response parameters for use in seismic design. Whereas R is a key parameter being addressed, related design parameters such as the overstrength factor, Ω_0 , and the deflection amplification factor, C_d , also are addressed. Collectively, these terms are referred to as “seismic design coefficients (or factors).” Future systems are likely to derive their seismic design coefficients (or factors) using this methodology, and existing system coefficients (or factors) also may be reviewed in light of this new procedure.

Height limits have been specified in codes and standards for more than 50 years. The structural system limitations and limits on structural height, specified in Table 12.2-1, evolved from these initial limitations and were further modified by the collective expert judgment of the NEHRP Provisions Update Committee (PUC) and the ATC-3 project team (the forerunners of the PUC). They have continued to evolve over the past 30 years based on observations and testing, but the specific values are based on subjective judgment.

In a bearing wall system, major load-carrying columns are omitted and the walls carry a major portion of the gravity (dead and live) loads. The walls supply in-plane lateral stiffness and strength to resist wind and earthquake loads and other lateral loads. In some cases, vertical trusses are used to augment lateral stiffness. In general, lack of redundancy for support of vertical and horizontal loads causes values of R to be lower for this system compared with R values of other systems.

In a building frame system, gravity loads are carried primarily by a frame supported on columns rather than by bearing walls. Some portions of the gravity load may be carried on bearing walls, but the amount carried should represent a relatively small percentage of the floor or roof area. Lateral resistance is provided by shear walls or braced frames. Light-framed walls with shear panels are intended for use only with wood

and steel building frames. Although gravity load-resisting systems are not required to provide lateral resistance, most of them do. To the extent that the gravity load-resisting system provides additional lateral resistance, it enhances the building's seismic performance capability, so long as it is capable of resisting the resulting stresses and undergoing the associated deformations.

In a moment-resisting frame system, moment-resisting connections between the columns and beams provide lateral resistance. In Table 12.2-1, such frames are classified as ordinary, intermediate, or special. In high seismic design categories, the anticipated ground motions are expected to produce large inelastic demands, so special moment frames designed and detailed for ductile response in accordance with Chapter 14 are required. In low Seismic Design Categories, the inherent overstrength in typical structural designs is such that the anticipated inelastic demands are somewhat reduced, and less ductile systems may be used safely. Because these less ductile ordinary framing systems do not possess as much toughness, lower values of R are specified.

The values for R , Ω_0 , and C_d at the composite systems in Table 12.2-1 are similar to those for comparable systems of structural steel and reinforced concrete. Use of the tabulated values is allowed only when the design and detailing requirements in Section 14.3 are followed.

In a dual system, a three-dimensional space frame made up of columns and beams provides primary support for gravity loads. Primary lateral resistance is supplied by shear walls or braced frames, and secondary lateral resistance is provided by a moment frame complying with the requirements of Chapter 14.

Where a beam-column frame or slab-column frame lacks special detailing, it cannot act as an effective backup to a shear wall subsystem, so there are no dual systems with ordinary moment frames. Instead, Table 12.2-1 permits the use of a shear wall-frame interactive system with ordinary reinforced concrete moment frames and ordinary reinforced concrete shear walls. Use of this defined system, which requires compliance with Section 12.2.5.8, offers a significant advantage over a simple combination of the two constituent ordinary reinforced concrete systems. Where those systems are simply combined, Section 12.2.3.3 would require use of seismic design parameters for an ordinary reinforced concrete moment frame.

In a cantilevered column system, stability of mass at the top is provided by one or more columns with base fixity acting as a single-degree-of-freedom system.

Cantilever column systems are essentially a special class of moment-resisting frame, except that they do not possess the redundancy and overstrength that most moment-resisting frames derive from sequential formation of yield or plastic hinges. Where a typical moment-resisting frame must form multiple plastic hinges in members to develop a yield mechanism, a cantilever column system develops hinges only at the base of the columns to form a mechanism. As a result, their overstrength is limited to that provided by material overstrength and by design conservatism.

It is permitted to construct cantilever column structures using any of the systems that can be used to develop moment frames, including ordinary and special steel; ordinary, intermediate, and special concrete; and timber frames. The system limitations for cantilever column systems reflect the type of moment frame detailing provided but with a limit on structural height, H , of 35 ft (10.7 m).

The value of R for cantilever column systems is derived from moment-resisting frame values where R is divided by Ω_0 but is not taken as less than 1 or greater than 2 and one-half. This range accounts for the lack of sequential yielding in such systems. C_d is taken as equal to R , recognizing that damping is quite low in these systems and inelastic displacement of these systems is not less than the elastic displacement.

Reinforced concrete ductile coupled walls have been added under bearing wall systems, building frame systems, and dual systems with special moment frames in ASCE 7-16 Table 12.2-1. In addition, steel and concrete coupled composite plate shear walls have been added under building frame systems and dual systems with special moment frames.

The addition of reinforced concrete ductile coupled walls is based on the development of definitions and design provisions for this system in ACI 318-19 and recent research that demonstrates adequate adjusted collapse margin ratios using the FEMA P695 methodology (Tauberg et al, 2019).

Composite Plate Shear Wall—Concrete Filled (C-PSW/CF) is an efficient seismic force-resisting system for buildings and is already addressed by ASCE 7-16. Coupled Composite Plate Shear Walls—Concrete Filled (Coupled-C-PSW/CF) are more ductile and have more redundancy than non-coupled composite plate shear walls, but ASCE 7-16 did not assign them seismic design coefficients and factors in Table 12.2-1. A FEMA P-695 study was conducted to substantiate the design coefficients and factors that should be used for such Coupled-C-PSW/CF structures. Adding this as a separate category in Table 12.2-1 is important because modern high-rise buildings often have core-wall systems; many of these core walls could utilize the Coupled-C-PSW/CF.

Section 14.3.5 added to ASCE 7-16 provides specific provisions for the definition and application of this Coupled-C-PSW/CF system, including details on the design philosophy and limits of applicability.

A FEMA P-695 study on Coupled-C-PSW/CF outlines the steps of the collapse assessment studies performed that have led to the proposed design provisions (Bruneau et al, 2019) and the study consisted of the following steps:

- 1) Development of a thorough set of design requirements prescribed for Coupled-C-PSW/CF. These design requirements are presented in detail in Chapter 14.3.5. Key aspects of the design requirements include:
 - a. Limiting coupling beam span-to-depth aspect ratios from 3 to 5 to ensure flexurally dominant behavior and plastic hinging, and requiring coupling beams with aspect ratio greater than or equal to 3 for all stories of the building, and less than or equal to 5 for at least 90% of the stories of the building.
 - b. Calculation of design demands for the composite walls using a capacity-limited seismic load effect, E_{cl} , obtained considering all the coupling beams developing plastic hinges with capacities of 1.2 times their expected plastic moment;
 - c. Limits on plate slenderness ratio for walls and coupling beam, to ensure development of plastic moment;
 - d. Dimensional constraints, which when combined with the limits on plate slenderness ratio, contribute to ensuring substantial coupling beams sizes and coupling ratios;
 - e. Minimum height-to-width ratio of 4 for each individual wall of the coupled-walls system, to develop flexurally-dominated wall deformations and therefore engage all coupling beams into the system's plastic mechanism;
 - f. Requirements for design of steel module under wet concrete condition, that govern the design of ties;
 - g. Amplification of calculated shear demand by a factor of 4, then compared against provided shear strength equations (note that the shear strength for these walls is large and rarely governs);
 - h. Specified minimum plastic rotation capacities for the coupling beams, with adequacy of coupling beam detailing to be based on experimental evidence or demonstrated by other approved methods;
 - i. Specified wall-to-foundation connection demands requirements;
 - j. Other requirements to achieve consistency with AISC-341 provisions, such as definition of protected zones, demand critical welds, and wall stiffness.
- 2) Design of 3-story, 8-story, 12-story, 18 story, and 22-story archetypes following the above design requirements, each considering 4 different coupled-walls, resulting in a total of 20 different archetypes. The archetypes were designed using an R value of 8 and C_d value of 5.5. The 3, 8 and 12-story archetype structures used planar composite walls, while the 18 and 22 story archetype structures used C-shaped walls.

- 3) Selection, validation, and calibration of the non-linear models used in that study. The numerical models for the structures accounted for the various complexities of flexural behavior of the coupling beams and composite walls. Two different set of non-linear models were considered and Incremental Dynamic Analyses (IDA) were performed in parallel, using these two different sets of non-linear models to assess sensitivity of the results. This contributed to enhance confidence in the results and provide a more robust validation of the proposed design provisions and seismic design coefficients and factors. For the first IDA, walls and coupling beams were both modeled using a fiber model able to capture the effects of concrete cracking, steel yielding, local buckling, concrete crushing, and steel inelastic behavior up to fracture due to cumulative plastic strains and low cycle fatigue. A thorough set of analyses were performed on example structures to ensure that the mechanics of the cross-section and member behavior was duly captured. For the second set of IDA, a discrete hinge model was used for the coupling beams, while the wall was modeled using a fiber model with effective stress-strain relationships assigned based on 3D finite element analysis results that implicitly accounted for the effects of steel local buckling, yielding and fracture and concrete cracking, crushing and confinement. For both sets of models, the numerical models were benchmarked using experimental data available in the literature, and calibrated to match both the experimentally-obtained force-displacement and moment-rotation hysteretic curves, including full stiffness and strength degradation due to buckling, fracture, and other non-linear behavior. Models calibrated on experimental results for planar walls were used for the 3, 8 and 12 story archetypes, and on experimental results for C-shaped walls for the 18 and 22 story archetypes. To further understand the mechanics of seismic response for the structural system, additional studies were performed to track the evolution of damage of selected archetype coupled-walls to identify the onset and full development of key limit states, such as yielding and fracture of coupling beams and walls. Non-linear finite element analyses were conducted in parallel for these selected archetypes to provide greater insights into the ultimate behavior of the structural system upon increasing severity of ground motion excitation.
- 4) Details of the parameters used in all non-linear time history dynamic analyses performed on the IDA for the two sets of non-linear models considered.
- 5) Findings from the Incremental Dynamic Analyses (IDA) performed, and resulting Adjusted Collapse Margin Ratio (ACMR) values for all of the archetypes considered.

Results from the FEMA P-695 studies indicated that all archetypes reached collapse at drifts greater than 5%, but all collapse margin ratios established in this study were conservatively calculated based on results obtained at 5% drift (i.e., at less than actual collapse points). Results of the FEMA P695 studies indicated that collapse margin ratios increased for the taller buildings, which is consistent with the fact that code-specified drift limits governed the design of the 18 and 22 stories archetypes. For all the archetypes considered, the lowest obtained calculated Adjusted Collapse Margin Ratios were respectively 3.55, 3.54, 4.02, 4.75, and 6.5 for the 3, 8, 12, 18, and 22 story archetypes for the IDA conducted with the first set of non-linear models; corresponding values of 2.89, 3.04, and 4.28, were respectively obtained for the 3, 8, and 12, story archetypes for the IDA conducted with the second set of non-linear models. All ACMR were calculated for a $\mu_T = 3.0$. These ACMR were compared with the acceptable adjusted collapse margin ratio values of 1.96 and 1.56 for $ACMR_{10\%}$ and $ACMR_{20\%}$. These values are obtained for a total system collapse uncertainty, β_{TOT} , calculated using a “good” rating for the design requirements related collapse uncertainty, test data related collapse uncertainty, and modelling related collapse uncertainty (incidentally, the ACMR would have been found acceptable even if the ratings had been “fair”, or even mostly “poor”). Overstrength factor, Ω_o , for the archetypes were found to be on the order of 2.0 to 2.5, and the C_d for the archetypes were found to be the order of 5 to 6. Upon review of response time histories, the large ACMR obtained for overstrength factors of this magnitude were found to be attributable to the considerable period elongation that developed as the

coupled beams progressively failed, and the fact that the walls hinged only at their base and had considerable shear strength along their height, precluding story-mechanisms.

The drift ratio for DBE is calculated by amplifying the drift ratio, calculated using an elastic model of the structure subjected to ELF, by C_d . Thus, the value of C_d depends on the stiffness of models used for conducting elastic analysis of the structure subjected to ELF. The stiffness recommendations for reinforced concrete (RC) structures (given in ACI 318) generally utilize a proportion of the gross section properties to estimate the stiffness of the RC members (walls and coupling beams). These stiffness recommendations are quite approximate and variable in the sense that the engineer can assume (with some justification) slightly different proportions of the gross section properties to estimate the RC member stiffnesses. Based on studies conducted by Wallace et al. (2019), a value of C_d equal to R , equal to 8, is recommended for structures with coupled RC walls. The stiffness recommendations for coupled composite core wall structures (given in Section 14.3.5 for the composite walls and coupling beams) are based on the calculated moment-curvature response of the composite cross section and explicitly account for the contributions of the structural steel modules and cracked concrete components. These stiffness values are relatively accurate, and based on the studies conducted by Bruneau and Varma et al. (2019), a value of C_d equal to 5.5, less than the value of $R=8$, is recommended for structures with coupled composite plate shear walls. This value of C_d was verified using the results of FEMA P695 studies conducted for the system.

Requirements for CLT shear walls and associated seismic design coefficients are based on research that demonstrates adequate adjusted collapse margin ratios using the FEMA P695 methodology (van de Lindt et al., 2019). Two variants of the CLT shear wall system are addressed in Table 12.2-1: a) CLT shear wall system with ratio of wall panel height, h , to individual wall panel length, b_s , of between 2 and 4, and b) CLT shear wall system with shear resistance provided by high aspect ratio panels only where high aspect ratio is defined as wall panel height to individual wall panel length ratio of 4. The system overstrength factor of $\Omega_0 = 3$ is based on nonlinear static pushover analysis results that ranged from 2.02 to 4.03 for the performance groups studied. The response modification factor $R = 3$ for CLT shear walls and $R=4$ for CLT shear walls with shear resistance provided by high aspect ratio panels only recognizes improved displacement capacity associated with use of high aspect ratio CLT panels and has been validated by incremental dynamic analysis results indicating collapse probabilities of less than 10%. The deflection amplification factor of $C_d = 3$ for CLT shear walls and $C_d = 4$ for CLT shear walls of high aspect ratio only is based on $C_d = R$ in accordance with the FEMA P695 methodology.

C12.2.1.1 Alternative Structural Systems.

Historically, this standard has permitted the use of alternative seismic force-resisting systems subject to satisfactory demonstration that the proposed systems' lateral force resistance and energy dissipation capacity is equivalent to structural systems listed in Table 12.2-1, for equivalent values of the response modification coefficient, R , overstrength factor, Ω_0 , and deflection amplification coefficient, C_d . These design factors were established based on limited analytical and laboratory data and the engineering judgment of the developers of the standard.

Under funding from the Federal Emergency Management Agency, the Applied Technology Council developed a rational methodology for validation of design criteria for seismic force-resisting systems under its ATC-63 project. Published as *FEMA P-695* (2009b), this methodology recognizes that the fundamental goal of seismic design rules contained in the standard is to limit collapse probability to acceptable levels. The *FEMA P-695* methodology uses nonlinear response history analysis to predict an adjusted collapse margin ratio (ACMR) for a suite of archetypical structures designed in accordance with a proposed set of system-specific design criteria and subjected to a standard series of ground motion accelerograms. The suite of archetypical structures is intended to represent the typical types and sizes of structures that are likely to incorporate the system. The ACMR relates to the conditional probability of collapse given MCE_R shaking

and considers uncertainties associated with the record-to-record variability of ground motions, the quality of the design procedure, the comprehensiveness and quality of the laboratory data upon which the analytical modeling is based; and uncertainties associated with the analytical modeling. Subsequent studies have been used to benchmark this methodology against selected systems contained in Table 12.2-1 and have demonstrated that the methodology provides rational results consistent with past engineering judgment for many systems. The *FEMA P-695* methodology is therefore deemed to constitute the preferred procedure for demonstrating adequate collapse resistance for new structural systems not currently contained in Table 12.2-1.

Under the *FEMA P-695* methodology, the archetypes used to evaluate seismic force-resisting systems are designed using the criteria for Risk Category II structures and are evaluated to demonstrate that the conditional probability of collapse of such structures conforms to the 10% probability of collapse goal stated in this section and also described in Section C1.3.1 of the commentary to this standard. It is assumed that application of the seismic importance factors and more restrictive drift limits associated with the design requirements for structures assigned to Risk Categories III and IV will provide such structures with the improved resistance to collapse described in Section C1.3.1 for those Risk Categories.

The FEMA P-695 Methodology was developed to provide a procedure to validate the major design parameters for existing seismic force-resisting systems and establish these parameters for new or alternative systems. It is intended that Standards Development Organizations such as ASCE/SEI are responsible to establish the design parameters for new or alternative systems for including in Table 12.2-1. Authorities Having Jurisdiction should not allow the addition of new or alternative systems on a local basis unless they have followed a process with the same rigor as a Standards Development Organization.

In addition to providing a basis for establishment of design criteria for alternative seismic force-resisting systems that can be used for design of a wide range of structures, the *FEMA P-695* methodology also contains a building-specific methodology intended for application to individual structures that have seismic force-resisting systems that do not comply with those identified in Table 12.2-1. This section may therefore be used by Authorities Having Jurisdiction to permit single building applications for a given site for structures with seismic force-resisting systems that do not conform to one of the systems designated in Table 12.2-1. Nothing contained in this section is intended to require the use of *FEMA P-695* or similar methodologies for such cases.

The rigor associated with application of the *FEMA P-695* methodology may not be appropriate to the design of individual structures that conform with limited and clearly defined exceptions to the criteria contained in the standard for a defined structural system, such as exceeding specified height limits (see the exception in Section 12.2.1).

C12.2.1.2 Elements of Seismic Force-Resisting Systems.

This standard and its referenced standards specify design and detailing criteria for members and their connections (elements) of seismic force-resisting systems defined in Table 12.2-1. Substitute elements replace portions of the defined seismic force-resisting systems. Examples include proprietary products made up of special steel moment-resisting connections or proprietary shear walls for use in light-frame construction. Requirements for qualification of substitute elements of seismic force-resisting systems are intended to ensure equivalent seismic performance of the element and the system as a whole. The evaluation of suitability for substitution is based on comparison of key performance parameters of the code-defined (conforming) element and the substitute element.

FEMA P-795, *Quantification of Building Seismic Performance Factors: Component Equivalency Methodology* (2011) is an acceptable methodology to demonstrate equivalence of substitute elements and their connections and provides methods for component testing, calculation of parameter statistics from test data, and acceptance criteria for evaluating equivalency. Key performance parameters include strength ratio, stiffness ratio, deformation capacity, and cyclic strength and stiffness characteristics.

Section 12.2.1.2, item f, requires independent design review as a condition of approval of the use of substitute elements. It is not the intent that design review be provided for every project that incorporates a substitute component, but rather that such review would be performed one time, as part of the general qualification of such substitute components. When used on individual projects, evidence of such review could include an evaluation service report or review letter indicating the conditions under which use of the substitute component is acceptable.

C12.2.2 Combinations of Framing Systems in Different Directions.

Different seismic force-resisting systems can be used along each of the two orthogonal axes of the structure, as long as the respective values of C_d , Ω_0 , and R are used. Depending on the combination selected, it is possible that one of the two systems may limit the extent of the overall system with regard to structural system limitations or structural height, h_n ; the more restrictive of these would govern.

C12.2.3 Combinations of Framing Systems in the Same Direction.

The intent of the provision requiring use of the most stringent seismic design parameters (R , Ω_0 , and C_d) is to prevent mixed seismic force-resisting systems that could concentrate inelastic behavior in the lower stories.

C12.2.3.1 R, C_d , and Ω_0 Values for Vertical Combinations.

This section expands upon Section 12.2.3 by specifying the requirements specific to the cases where (a) the value of R for the lower seismic force-resisting system is lower than that for the upper system, and (b) the value of R for the upper seismic force-resisting system is lower than that for the lower system.

The two cases are intended to account for all possibilities of vertical combinations of seismic force-resisting systems in the same direction. For a structure with a vertical combination of three or more seismic force-resisting systems in the same direction, Section 12.2.3.1 must be applied to the adjoining pairs of systems until the vertical combinations meet the requirements therein.

There are also exceptions to these requirements for conditions that do not affect the dynamic characteristics of the structure or that do not result in concentration of inelastic demand in critical areas.

C12.2.3.2 Two-Stage Analysis Procedure.

A two-stage equivalent lateral force procedure is permitted where the lower portion of the structure has a minimum of 10 times the stiffness of the upper portion of the structure. In addition, the period of the entire structure is not permitted to be greater than 1.1 times the period of the upper portion considered as a separate structure supported at the transition from the upper to the lower portion. An example would be a concrete podium under a wood- or steel-framed upper portion of a structure. The upper portion may be analyzed for seismic forces and drifts using the values of R , Ω_0 , and C_d for the upper portion as a separate structure.

The seismic forces (e.g., shear and overturning) at the base of the upper portion are applied to the top of the lower portion and scaled up by the ratio of $(R/\rho)_{\text{upper}}$ to $(R/\rho)_{\text{lower}}$. The lower portion, which now includes the seismic forces from the upper portion, may then be analyzed using the values of R , Ω_0 , and C_d for the lower portion of the structure.

C12.2.3.2.2 incorporates a two-stage analysis for flexible diaphragms supported on rigid vertical elements that is conceptually parallel to the two-stage analysis already permitted for flexible superstructures supported on rigid base structures. This approach is based on numerical studies conducted as part of development of the 2015 guideline document *Seismic Design of Rigid Wall-Flexible Diaphragm Buildings: An Alternate Procedure* (FEMA P-1026). The numerical studies and the resulting seismic design methodology specifically recognized the dynamic response of rigid wall-flexible diaphragm structures as

being dominated by dynamic response of and inelastic behavior in the diaphragm. Standard design procedures require the designer to determine seismic forces to vertical elements based on the approximate period of the vertical elements, irrespective of diaphragm response. Section 12.2.3.2.2, however, permits the designer to recognize the reduction in seismic design forces to the vertical elements resulting from the anticipated longer period of the diaphragm. The provisions of Sec. 12.2.3.2.2 are parallel to the provisions of 12.2.3.2.1 in order to convey the similarity in concept.

Item a requires that this provision be used in combination with the Sec. 12.10.4 provisions. Sec. 12.10.4 establishes scoping requirements that limit use to rigid vertical element-flexible diaphragm structure types, derived based on the FEMA P-1026 numerical studies. Sec. 12.10.4 also provides equations for determination of diaphragm design forces, F_{px} , intended to be used in the Item b sum of forces.

Item b requires that diaphragm design forces be combined with in-plane vertical element forces determined using the equivalent lateral force procedure of Sec. 12.8, in order to be consistent with the FEMA P-1026 basis. If other methods are used to determine in-plane forces to the vertical elements, this could result in a duplication of the force reduction due to diaphragm flexibility.

Item b1 requires that the lateral seismic forces contributed by the diaphragm be amplified by a ratio of R and ρ factors. Note that per section 12.10.4.2, ρ for the diaphragm is to be 1.0. This amplification directly parallels the provisions of Sec. 12.2.3.2.1. Note that this amplification is applied to the seismic forces calculated in accordance with Eq. (12.10-15). The shear amplification of Section 12.10.4.2.2 need not be included.

Item b2 requires consideration of seismic forces applied to the vertical elements not entering through the horizontal diaphragm. Typically, these forces are from the vertical element's self-weight and other effective seismic weights in the same plane as the vertical element. This total effective seismic weight induces seismic design forces associated with the in-plane vertical element's period and response modification factor.

C12.2.3.3 R , C_d , and Ω_0 Values for Horizontal Combinations.

For almost all conditions, the least value of R of different seismic force-resisting systems in the same direction must be used in design. This requirement reflects the expectation that the entire system will undergo the same deformation with its behavior controlled by the least ductile system. However, for light-frame construction or flexible diaphragms meeting the listed conditions, the value of R for each independent line of resistance can be used. This exceptional condition is consistent with light-frame construction that uses the ground for parking with residential use above.

C12.2.4 Combination Framing Detailing Requirements.

This requirement is provided so that the seismic force-resisting system with the highest value of R has the necessary ductile detailing throughout. The intent is that details common to both systems be designed to remain functional throughout the response to earthquake load effects to preserve the integrity of the seismic force-resisting system.

C12.2.5 System-Specific Requirements

C12.2.5.1 Dual System.

The moment frame of a dual system must be capable of resisting at least 25% of the design seismic forces; this percentage is based on judgment. The purpose of the 25% frame is to provide a secondary seismic force-resisting system with higher degrees of redundancy and ductility to improve the ability of the building to support the service loads (or at least the effect of gravity loads) after strong earthquake shaking. The primary system (walls or bracing) acting together with the moment frame must be capable of resisting all of the design seismic forces. The following analyses are required for dual systems:

1. The moment frame and shear walls or braced frames must resist the design seismic forces, considering fully the force and deformation interaction of the walls or braced frames and the moment frames as a single system. This analysis must be made in accordance with the principles of structural mechanics that consider the relative rigidities of the elements and torsion in the system. Deformations imposed upon members of the moment frame by their interaction with the shear walls or braced frames must be considered in this analysis.
2. The moment frame must be designed with sufficient strength to resist at least 25% of the design seismic forces.

C12.2.5.2 Cantilever Column Systems.

Cantilever column systems are singled out for special consideration because of their unique characteristics. These structures often have limited redundancy and overstrength and concentrate inelastic behavior at their bases. As a result, they have substantially less energy dissipation capacity than other systems. A number of apartment buildings incorporating this system experienced severe damage and, in some cases, collapsed in the 1994 Northridge (California) earthquake. Because the ductility of columns that have large axial stress is limited, cantilever column systems may not be used where individual column axial demands from seismic load effects exceed 15% of their available axial strength, including slenderness effects.

Elements providing restraint at the base of cantilever columns must be designed for seismic load effects, including overstrength, so that the strength of the cantilever columns is developed.

C12.2.5.3 Inverted Pendulum-Type Structures.

Inverted pendulum-type structures do not have a unique entry in Table 12.2-1 because they can be formed from many structural systems. Inverted pendulum-type structures have more than half of their mass concentrated near the top (producing one degree of freedom in horizontal translation) and rotational compatibility of the mass with the column (producing vertical accelerations acting in opposite directions). Dynamic response amplifies this rotation; hence, the bending moment induced at the top of the column can exceed that computed using the procedures of Section 12.8. The requirement to design for a top moment that is one-half of the base moment calculated in accordance with Section 12.8 is based on analyses of inverted pendulums covering a wide range of practical conditions.

C12.2.5.4 Increased Structural Height Limit for Steel Eccentrically Braced Frames, Steel Special Concentrically Braced Frames, Steel Buckling-Restrained Braced Frames, Steel Special Plate Shear Walls, and Special Reinforced Concrete Shear Walls.

The first criterion for an increased limit on structural height, h_n , precludes extreme torsional irregularity because premature failure of one of the shear walls or braced frames could lead to excessive inelastic torsional response. The second criterion, which is similar to the redundancy requirements, is to limit the structural height of systems that are too strongly dependent on any single line of shear walls or braced frames. The inherent torsion resulting from the distance between the center of mass and the center of rigidity must be included, but accidental torsional effects are neglected for ease of implementation.

C12.2.5.5 Special Moment Frames in Structures Assigned to Seismic Design Categories D through F.

Special moment frames, either alone or as part of a dual system, are required to be used in Seismic Design Categories D through F where the structural height, h_n , exceeds 160 ft (48.8 m) (or 240 ft [73.2 m]) for buildings that meet the provisions of Section 12.2.5.4) as indicated in Table 12.2-1. In shorter buildings where special moment frames are not required to be used, the special moment frames may be discontinued

and supported on less ductile systems as long as the requirements of Section 12.2.3 for framing system combinations are followed.

For the situation where special moment frames are required, they should be continuous to the foundation. In cases where the foundation is located below the building's base, provisions for discontinuing the moment frames can be made as long as the seismic forces are properly accounted for and transferred to the supporting structure.

C12.2.5.6 Steel Ordinary Moment Frames.

Steel ordinary moment frames (OMFs) are less ductile than steel special moment frames; consequently, their use is prohibited in structures assigned to Seismic Design Categories D, E, and F (Table 12.2-1). Structures with steel OMFs, however, have exhibited acceptable behavior in past earthquakes where the structures were sufficiently limited in their structural height, number of stories, and seismic mass. The provisions in the standard reflect these observations. The exception is discussed separately below. Table C12.2-1 summarizes the provisions.

Table C12.2-1 Summary of Conditions for OMFs and IMFs in Structures Assigned to Seismic Design Category D, E, or F (Refer to the Standard for Additional Requirements)

							Exterior Wall DL	
Section	Frame	SDC	Max. Number Stories	Light-Frame Construction	Max. ft	Max. roof/floor D_L (lb/ft ²)	Max. (lb/ft ²)	Wall ^a Height (ft)
12.2.5.6.1(a)	OMF	D, E	1	NA	65	20	20	35
12.2.5.6.1(a)-Exc	OMF	D, E	1	NA	NL	20	20	35
12.2.5.6.1(b)	OMF	D, E	NL	Required	35	35	20	0
12.2.5.6.2	OMF	F	1	NA	65	20	20	0
12.2.5.7.1(a)	IMF	D	1	NA	65	20	20	35
12.2.5.7.1(a)-Exc	IMF	D	1	NA	NL	20	20	35
12.2.5.7.1(b)	IMF	D	NL	NA	35	NL	NL	NA
12.2.5.7.2(a)	IMF	E	1	NA	65	20	20	35
12.2.5.7.2(a)-Exc	IMF	E	1	NA	NL	20	20	35
12.2.5.7.2(b)	IMF	E	NL	NA	35	35	20	0

12.2.5.7.3(a)	IMF	F	1	NA	65	20	20	0
12.2.5.7.3(b)	IMF	F	NL	Required	35	35	20	0

Note: NL means No Limit; NA means Not Applicable. For metric units, use 20 m for 65 ft and use 10.6 m for 35 ft. For 20 lb/ft², use 0.96 kN/m² and for 30 lb/ft², use 1.68 kN/m².

^aApplies to portion of wall above listed wall height.

C12.2.5.6.1 Seismic Design Category D or E.

Single-story steel OMFs are permitted, provided that (a) the structural height, h_n , is a maximum of 65 ft (20 m), (b) the dead load supported by and tributary to the roof is a maximum of 20 lb/ft² (0.96 kN/m²), and (c) the dead load of the exterior walls more than 35 ft (10.6 m) above the seismic base tributary to the moment frames is a maximum of 20 lb/ft² (0.96 kN/m²).

In structures of light-frame construction, multistory steel OMFs are permitted, provided that (a) the structural height, h_n , is a maximum of 35 ft (10.6 m), (b) the dead load of the roof and each floor above the seismic base supported by and tributary to the moment frames are each a maximum of 35 lb/ft² (1.68 kN/m²), and (c) the dead load of the exterior walls tributary to the moment frames is a maximum of 20 lb/ft² (0.96 kN/m²).

EXCEPTION: Industrial structures, such as aircraft maintenance hangars and assembly buildings, with steel OMFs have performed well in past earthquakes with strong ground motions (EQE Inc. 1983, 1985, 1986a, 1986b, 1986c, and 1987); the exception permits single-story steel OMFs to be unlimited in height provided that (a) the structure is limited to the enclosure of equipment or machinery; (b) its occupants are limited to maintaining and monitoring the equipment, machinery, and their associated processes; (c) the sum of the dead load and equipment loads supported by and tributary to the roof is a maximum of 20 lb/ft² (0.96 kN/m²); and (d) the dead load of the exterior wall system, including exterior columns more than 35 ft (10.6 m) above the seismic base is a maximum of 20 lb/ft² (0.96 kN/m²). Though the latter two load limits (Items C and D) are similar to those described in this section, there are meaningful differences.

The exception further recognizes that these facilities often require large equipment or machinery, and associated systems, not supported by or considered tributary to the roof, that support the intended operational functions of the structure, such as top running bridge cranes, jib cranes, and liquid storage containment and distribution systems. To limit the seismic interaction between the seismic force-resisting systems and these components, the exception requires the weight of equipment or machinery that is not self-supporting (i.e., not freestanding) for all loads (e.g., dead, live, or seismic) to be included when determining compliance with the roof or exterior wall load limits. This *equivalent* equipment load shall be in addition to the loads listed above.

To determine the equivalent equipment load, the exception requires the weight to be considered fully (100%) tributary to an area not exceeding 600 ft² (55.8 m²). This limiting area can be taken either to an adjacent exterior wall for cases where the weight is supported by an exterior column (which may also span to the first interior column) or to the adjacent roof for cases where the weight is supported entirely by an interior column or columns, but not both; nor can a fraction of the weight be allocated to each zone. Equipment loads within overlapping tributary areas should be combined in the same limiting area. Other provisions in the standard, as well as in past editions, require satisfying wall load limits tributary to the moment frame, but this requirement is not included in the exception in that it is based on a component-level approach that does not consider the interaction between systems in the structure. As such, the limiting area is considered to be a reasonable approximation of the tributary area of a moment frame segment for the purpose of this conversion. Although this weight allocation procedure may not represent an accurate

physical distribution, it is considered to be a reasonable method for verifying compliance with the specified load limits to limit seismic interactions. The engineer must still be attentive to actual mass distributions when computing seismic loads. Further information is discussed in Section C11.1.3.

C12.2.5.6.2 Seismic Design Category F.

Single-story steel OMFs are permitted, provided that they meet conditions (a) and (b) described in Section C12.2.5.6.1 for single-story frames and (c) the dead load of the exterior walls tributary to the moment frames is a maximum of 20 lb/ft² (0.96 kN/m²).

C12.2.5.7 Steel Intermediate Moment Frames.

Steel intermediate moment frames (IMFs) are more ductile than steel ordinary moment frames (OMFs) but less ductile than steel special moment frames; consequently, restrictions are placed on their use in structures assigned to Seismic Design Category D and their use is prohibited in structures assigned to Seismic Design Categories E and F (Table 12.2-1). As with steel OMFs, steel IMFs have also exhibited acceptable behavior in past earthquakes where the structures were sufficiently limited in their structural height, number of stories, and seismic mass. The provisions in the standard reflect these observations. The exceptions are discussed separately (following). Table C12.2-1 summarizes the provisions.

C12.2.5.7.1 Seismic Design Category D.

Single-story steel IMFs are permitted without limitations on dead load of the roof and exterior walls, provided that the structural height, h_n , is a maximum of 35 ft (10.6 m). An increase to 65 ft (20 m) is permitted for h_n , provided that (a) the dead load supported by and tributary to the roof is a maximum of 20 lb/ft² (0.96 kN/m²), and (b) the dead load of the exterior walls more than 35 ft (10.6 m) above the seismic base tributary to the moment frames is a maximum of 20 lb/ft² (0.96 kN/m²).

The exception permits single-story steel IMFs to be unlimited in height, provided that they meet all of the conditions described in the exception to Section C12.2.5.6.1 for the same structures.

C12.2.5.7.2 Seismic Design Category E.

Single-story steel IMFs are permitted, provided that they meet all of the conditions described in Section C12.2.5.6.1 for single-story OMFs.

The exception permits single-story steel IMFs to be unlimited in height, provided that they meet all of the conditions described in Section C12.2.5.6.1 for the same structures.

Multistory steel IMFs are permitted, provided that they meet all of the conditions described in Section C12.2.5.6.1 for multistory OMFs, except that the structure is not required to be of light-frame construction.

C12.2.5.7.3 Seismic Design Category F.

Single-story steel IMFs are permitted, provided that (a) the structural height, h_n , is a maximum of 65 ft (20 m), (b) the dead load supported by and tributary to the roof is a maximum of 20 lb/ft² (0.96 kN/m²), and (c) the dead load of the exterior walls tributary to the moment frames is a maximum of 20 lb/ft² (0.96 kN/m²).

Multistory steel IMFs are permitted, provided that they meet all of the conditions described in the exception to Section C12.2.5.6.1 for multistory OMFs in structures of light-frame construction.

C12.2.5.8 Shear Wall–Frame Interactive Systems.

For structures assigned to Seismic Design Category A or B (where seismic hazard is low), it is usual practice to design shear walls and frames of a shear wall–frame structure to resist lateral forces in proportion to their relative rigidities, considering interaction between the two subsystems at all levels. As discussed in Section

C12.2.1, this typical approach would require use of a lower response modification coefficient, R , than that defined for shear wall–frame interactive systems. Where the special requirements of this section are satisfied, more reliable performance is expected, justifying a higher value of R .

C12.3 DIAPHRAGM FLEXIBILITY, CONFIGURATION IRREGULARITIES, AND REDUNDANCY

C12.3.1 Diaphragm Flexibility.

Most seismic force-resisting systems have two distinct parts: the horizontal system, which distributes lateral forces to the vertical elements and the vertical system, which transmits lateral forces between the floor levels and the base of the structure.

The horizontal system may consist of diaphragms or a horizontal bracing system. For the majority of buildings, diaphragms offer the most economical and positive method of resisting and distributing seismic forces in the horizontal plane. Typically, diaphragms consist of a metal deck (with or without concrete), concrete slabs, and wood sheathing and/or decking. Although most diaphragms are flat, consisting of the floors of buildings, they also may be inclined, curved, warped, or folded configurations, and most diaphragms have openings.

The diaphragm stiffness relative to the stiffness of the supporting vertical seismic force-resisting system ranges from flexible to rigid and is important to define. Provisions defining diaphragm flexibility are given in Sections 12.3.1.1 through 12.3.1.3. If a diaphragm cannot be idealized as either flexible or rigid, explicit consideration of its stiffness must be included in the analysis.

The diaphragms in most buildings braced by wood light-frame shear walls are semirigid. Because semirigid diaphragm modeling is beyond the capability of available software for wood light-frame buildings, it is anticipated that this requirement will be met by evaluating force distribution using both rigid and flexible diaphragm models and taking the worse case of the two. Although this procedure is in conflict with common design practice, which typically includes only flexible diaphragm force distribution for wood light-frame buildings, it is one method of capturing the effect of the diaphragm stiffness.

C12.3.1.1 Flexible Diaphragm Condition.

Section 12.3.1.1 defines broad categories of diaphragms that may be idealized as flexible, regardless of whether the diaphragm meets the calculated conditions of Section 12.3.1.3. These categories include the following:

- a. Construction with relatively stiff vertical framing elements, such as steel-braced frames and concrete or masonry shear walls;
- b. One- and two-family dwellings; and
- c. Light-frame construction (e.g., construction consisting of light-frame walls and diaphragms) with or without nonstructural toppings of limited stiffness.

For item c above, compliance with story drift limits along each line of shear walls is intended as an indicator that the shear walls are substantial enough to share load on a tributary area basis and not require torsional force redistribution.

C12.3.1.2 Rigid Diaphragm Condition.

Span-to-depth ratio limits are included in the deemed-to-comply condition as an indirect measure of the flexural contribution to diaphragm stiffness.

C12.3.1.3 Calculated Flexible Diaphragm Condition.

A diaphragm is permitted to be idealized as flexible if the calculated diaphragm deflection (typically at midspan) between supports (lines of vertical elements) is greater than two times the average story drift of the vertical lateral force-resisting elements located at the supports of the diaphragm span.

Figure 12.3-1 depicts a distributed load, conveying the intent that the tributary lateral load be used to compute δ_{MDD} , consistent with the Section 11.3 symbols. A diaphragm opening is illustrated, and the shorter arrows in the portion of the diaphragm with the opening indicate lower load intensity because of lower tributary seismic mass.

C12.3.2 Irregular and Regular Classification.

The configuration of a structure can significantly affect its performance during a strong earthquake that produces the ground motion contemplated in the standard. Structural configuration can be divided into two aspects: horizontal and vertical. Most seismic design provisions were derived for buildings that have regular configurations, but earthquakes have shown repeatedly that buildings that have irregular configurations suffer greater damage. This situation prevails even with good design and construction.

There are several reasons for the poor behavior of irregular structures. In a regular structure, the inelastic response, including energy dissipation and damage, produced by strong ground shaking tends to be well distributed throughout the structure. However, in irregular structures, inelastic behavior can be concentrated by irregularities and can result in rapid failure of structural elements in these areas. In addition, some irregularities introduce unanticipated demands into the structure, which designers frequently overlook when detailing the structural system. Finally, the elastic analysis methods typically used in the design of structures often cannot predict the distribution of earthquake demands in an irregular structure very well, leading to inadequate design in the areas associated with the irregularity. For these reasons, the standard encourages regular structural configurations and prohibits gross irregularity in buildings located on sites close to major active faults, where very strong ground motion and extreme inelastic demands are anticipated. The termination of seismic force-resisting elements at the foundation, however, is not considered to be a discontinuity.

C12.3.2.1 Horizontal Irregularity.

A building may have a symmetric geometric shape without reentrant corners or wings but still be classified as irregular in plan because of its distribution of mass or vertical seismic force-resisting elements. Torsional effects in earthquakes can occur even where the centers of mass and rigidity coincide. For example, ground motion waves acting on a skew with respect to the building axis can cause torsion. Cracking or yielding in an asymmetric fashion also can cause torsion. These effects also can magnify the torsion caused by eccentricity between the centers of mass and rigidity. Torsional structural irregularities (Types 1a and 1b) are defined to address this concern. The ATC123 project (FEMA P-2012) quantified the effect of torsional structural response on collapse. Both the Type 1a and 1b irregularity classifications contained in Table 12.3-1, and the design provisions triggered by an irregularity classification, are intended to produce structural designs with roughly the same collapse potential in structures with and without a torsional response.

A square or rectangular building with minor reentrant corners would still be considered regular, but large reentrant corners creating a crucifix form would produce an irregular structural configuration (Type 2). The response of the wings of this type of building generally differs from the response of the building as a whole, and this difference produces higher local forces than would be determined by application of the standard without modification. Other winged plan configurations (e.g., H-shapes) are classified as irregular even if they are symmetric because of the response of the wings.

Significant differences in stiffness between portions of a diaphragm at a level are classified as Type 3 structural irregularities because they may cause a change in the distribution of seismic forces to the vertical components and may create torsional forces not accounted for in the distribution normally considered for a regular building.

Where there are discontinuities in the path of lateral force resistance, the structure cannot be considered regular. The most critical discontinuity defined is the out-of-plane offset of vertical elements of the seismic force-resisting system (Type 4). Such offsets impose vertical and lateral load effects on horizontal elements that are difficult to provide for adequately.

Where vertical lateral force-resisting elements are not parallel to the major orthogonal axes of the seismic force-resisting system, the equivalent lateral force procedure of the standard cannot be applied appropriately, so the structure is considered to have an irregular structural configuration (Type 5).

Figure C12.3-1 illustrates horizontal structural irregularities.

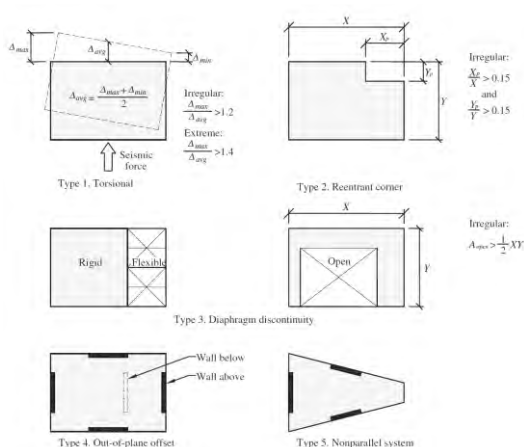

FIGURE C12.3-1 Horizontal Structural Irregularity Examples

C12.3.2.2 Vertical Irregularity.

Vertical irregularities in structural configuration affect the responses at various levels and induce loads at these levels that differ significantly from the distribution assumed in the equivalent lateral force procedure given in Section 12.8.

A moment-resisting frame building might be classified as having a soft story irregularity (Type 1) if one story is much taller than the adjoining stories and the design did not compensate for the resulting decrease in stiffness that normally would occur.

The ATC-123 (FEMA P-2012) project studied mass irregularities (as defined in ASCE 7-16) in concrete and steel moment frame buildings using FEMA P-695 methodology. The study concluded that collapse margin ratio of structures with a mass irregularity in moment frame structures was not substantially affected by the mass irregularity. Furthermore, structures proportioned using the Equivalent Lateral Force procedure produced very similar results as structures proportioned with the Modal Response Spectrum Analysis (MRSA) procedure.

The ATC-123 project also examined the effect of using ELF versus MRSA analysis on the design of structures with mass irregularities (as defined in ASCE 7-16), by comparing the story shear, story overturning moment and drifts between the two analysis methods. In most cases, the ELF demands for systems with large mass ratios (up to 10) are greater than or close to the MRSA demands, indicating that the ELF method will generally produce more conservative designs than the MRSA. The exception to this

general trend occurs in the upper few stories of taller buildings with mass irregularities, whereby MRSA produces higher story shears and overturning moments (but smaller drifts) in those stories. In these few cases, practical designs using the ELF method would still be sufficient to meet the intent of this standard unless the horizontal dimension of the seismic force-resisting system were greatly reduced above the mass irregularity; such a reduction would produce a vertical irregularity Type 2 (vertical geometric) irregularity, thus requiring use of the MRSA method for design of the system.

Based on this work, the idea that structures with additional mass at a given level(s) be required to be designed using the MRSA has been re-thought, and the concept of a “mass irregularity” has been removed from the standard. The user of this standard should be reminded that considering the spatial distribution of mass and modeling requirements of S12.7 remain important considerations in structural design, particularly in the instance where a mass is significant and can contribute to local force and displacements related to support of a mass (e.g. hanging masses such as central information centers in stadia). In these instances, dynamic analyses should be utilized to ensure dynamic and local effects related to seismic loads are adequately addressed in the design.

A vertical geometric irregularity (Type 2) applies regardless of whether the larger dimension is above or below the smaller one.

Vertical lateral force-resisting elements at adjoining stories that are offset from each other in the vertical plane of the elements and impose overturning demands on supporting structural elements, such as beams, columns, trusses, walls, or slabs, are classified as in-plane discontinuity irregularities (Type 3).

Buildings with a weak-story irregularity (Type 4) tend to develop all of their inelastic behavior and consequent damage at the weak story, possibly leading to collapse.

Figure C12.3-2 illustrates examples of vertical structural irregularities.

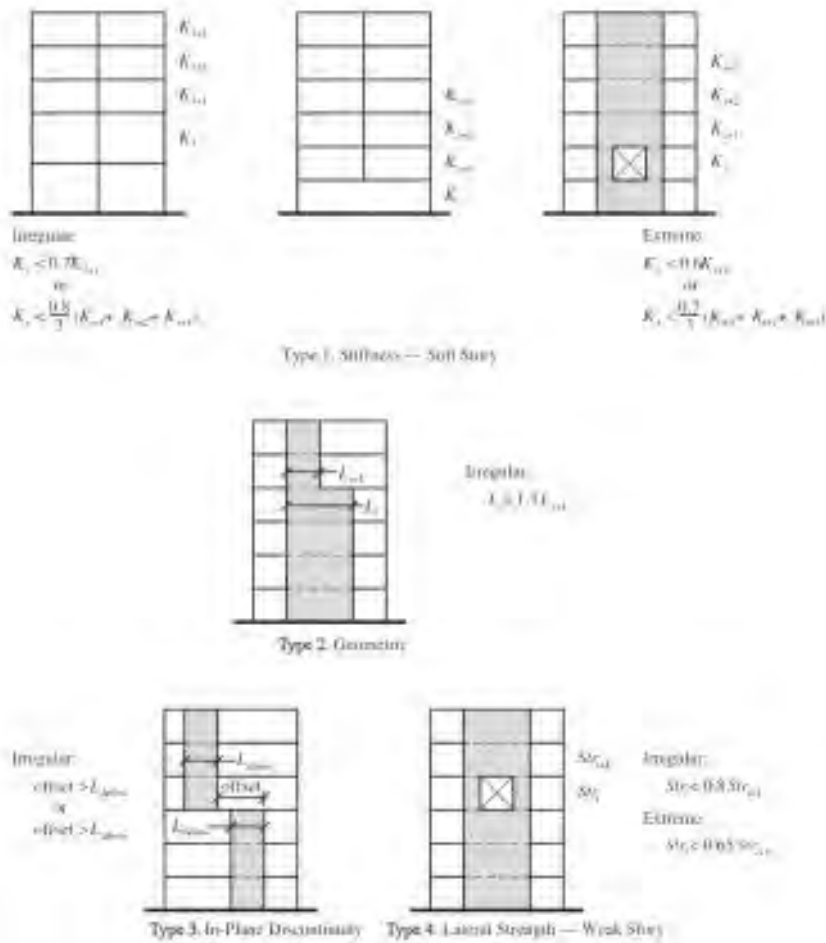

FIGURE C12.3-2 Vertical Structural Irregularities

C12.3.3 Limitations and Additional Requirements for Systems with Structural Irregularities

C12.3.3.1 Prohibited Horizontal and Vertical Irregularities for Seismic Design Categories D through F.

The prohibitions and limits caused by structural irregularities in this section stem from poor performance in past earthquakes and the potential to concentrate large inelastic demands in certain portions of the structure. Even where such irregularities are permitted, they should be avoided whenever possible in all structures.

C12.3.3.2 Extreme Weak Stories.

Because extreme weak story irregularities are prohibited in Section 12.3.3.1 for buildings located in Seismic Design Categories D, E, and F, the limitations and exceptions in this section apply only to buildings assigned to Seismic Design Category B or C. Weak stories of structures assigned to Seismic Design Category B or C that are designed for seismic load effects including overstrength are exempted because reliable inelastic response is expected.

C12.3.3.3 Elements Supporting Discontinuous Walls or Frames.

The purpose of requiring elements (e.g., beams, columns, trusses, slabs, and walls) that support discontinuous walls or frames to be designed to resist seismic load effects including overstrength is to protect the gravity load-carrying system against possible overloads caused by overstrength of the seismic force-resisting system. Either columns or beams may be subject to such failure; therefore, both should include this design requirement. Beams may be subject to failure caused by overloads in either the downward or upward directions of force. Examples include reinforced concrete beams, the weaker top laminations of glued laminated beams, or unbraced flanges of steel beams or trusses. Hence, the provision has not been limited simply to downward force, but instead to the larger context of “vertical load.” Additionally, walls that support isolated point loads from frame columns or discontinuous perpendicular walls or walls with significant vertical offsets, as shown in Figs. C12.3-3 and C12.3-4, can be subject to the same type of failure caused by overload.

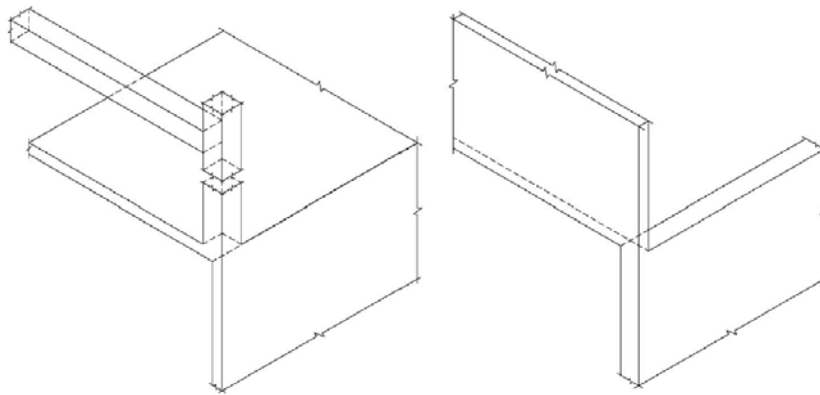

FIGURE C12.3-3 Vertical In-Plane-Discontinuity Irregularity from Columns or Perpendicular Walls (Type 3)

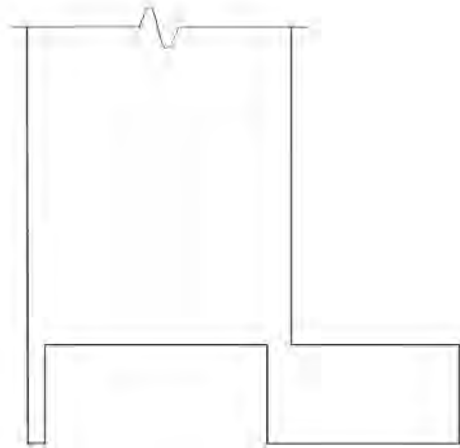

FIGURE C12.3-4 Vertical In-Plane-Discontinuity Irregularity from Walls with Significant Offsets (Type 3)

The connection between the discontinuous element and the supporting member must be adequate to transmit the forces required for the design of the discontinuous element. For example, where the discontinuous element is required to comply with the seismic load effects, including overstrength in Section

12.4.3, as is the case for a steel column in a braced frame or a moment frame, its connection to the supporting member is required to be designed to transmit the same forces. These same seismic load effects are not required for shear walls, and thus, the connection between the shear wall and the supporting member would only need to be designed to transmit the loads associated with the shear wall.

For wood light-frame shear wall construction, the final sentence of Section 12.3.3.3 results in the shear and overturning connections at the base of a discontinued shear wall (i.e., shear fasteners and tie-downs) being designed using the load combinations of Section 2.3 or 2.4 rather than the load combinations with overstrength of Section 12.4.3 (Figure C12.3-5). The intent of the first sentence of Section 12.3.3.3 is to protect the system providing resistance to forces transferred from the shear wall by designing the system for seismic load effects including overstrength; strengthening of the shear wall anchorage to this system is not required to meet this intent.

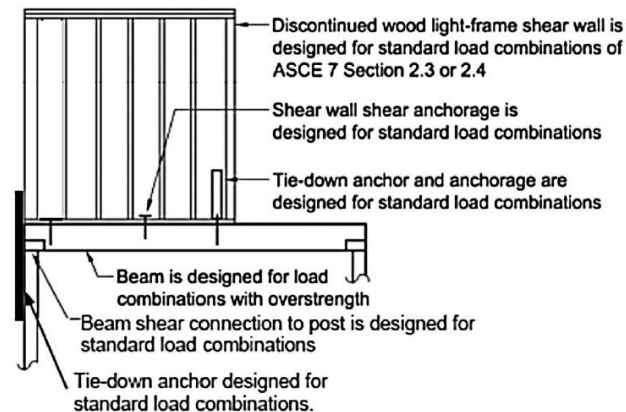

FIGURE C12.3-5 Discontinued Wood Light-Frame Shear Wall

C12.3.3.4 Increase in Forces Caused by Irregularities for Seismic Design Categories D through F.

The listed irregularities may result in loads that are distributed differently than those assumed in the equivalent lateral force procedure of Section 12.8, especially as related to the interconnection of the diaphragm with vertical elements of the seismic force-resisting system. The 25% increase in force is intended to account for this difference. Where the force is calculated using the seismic load effects including overstrength, no further increase is warranted.

C12.3.4 Redundancy.

The standard introduces a revised redundancy factor, ρ , for structures assigned to Seismic Design Category D, E, or F to quantify redundancy. The value of this factor is either 1.0 or 1.3. This factor has the effect of reducing the response modification coefficient, R , for less redundant structures, thereby increasing the seismic demand. The factor is specified in recognition of the need to address the issue of redundancy in the design.

The desirability of redundancy, or multiple lateral force-resisting load paths, has long been recognized. The redundancy provisions of this section reflect the belief that an excessive loss of story shear strength or development of an extreme torsional irregularity (Type 1b) may lead to structural failure. The value of ρ determined for each direction may differ.

C12.3.4.1 Conditions Where Value of ρ is 1.0.

This section provides a convenient list of conditions where ρ is 1.0.

C12.3.4.2 Redundancy Factor, ρ , for Seismic Design Categories D through F.

There are two approaches to establishing a redundancy factor, ρ , of 1.0. Where neither condition is satisfied, ρ is taken as equal to 1.3. It is permitted to take ρ equal to 1.3 without checking either condition. A reduction in the value of ρ from 1.3 is not permitted for structures assigned to Seismic Design Category D, E or F that have an extreme torsional irregularity (Type 1b) in both orthogonal directions. The ATC-123 project showed that structures with extreme torsional irregularities in both orthogonal direction or structures with all of their lateral resistance located on one side of the center of mass, should include a ρ of 1.3 to achieve the same probability of collapse as non-irregular structures.

The first approach is a check of the elements outlined in Table 12.3-3 for cases where the seismic design story shear exceeds 35% of the base shear. Parametric studies (conducted by Building Seismic Safety Council Technical Subcommittee 2 but unpublished) were used to select the 35% value. Those studies indicated that stories with story shears of at least 35% of the base shear include all stories of low-rise buildings (buildings up to five to six stories) and about 87% of the stories of tall buildings. The intent of this limit is to exclude penthouses of most buildings and the uppermost stories of tall buildings from the redundancy requirements. This approach only applies where lateral-force resisting elements are located on both sides of the center of mass. The ATC-123 study showed that structural configurations where all vertical resisting elements occurred on the same side of the center of mass should include a ρ of 1.3 to achieve the same probability of collapse as redundantly configured structures. Note that it's possible that configurations where all lines of lateral resistance are on the same side of the center of mass could pass the requirements of Table 12.3-3 without triggering an extreme torsional irregularity, especially in shear wall buildings where the aspect ratio of the walls do not trigger the removal of a wall per Table 12.3-3.

This approach requires the removal (or loss of moment resistance) of an individual lateral force-resisting element to determine its effect on the remaining structure. If the removal of elements, one by one, does not result in more than a 33% reduction in story strength or an extreme torsional irregularity, ρ may be taken as 1.0. For this evaluation, the determination of story strength requires an in-depth calculation. The intent of the check is to use a simple measure (elastic or plastic) to determine whether an individual member has a significant effect on the overall system. If the original structure has an extreme torsional irregularity to begin with, the resulting ρ is 1.3. Figure C12.3-6 presents a flowchart for implementing the redundancy requirements.

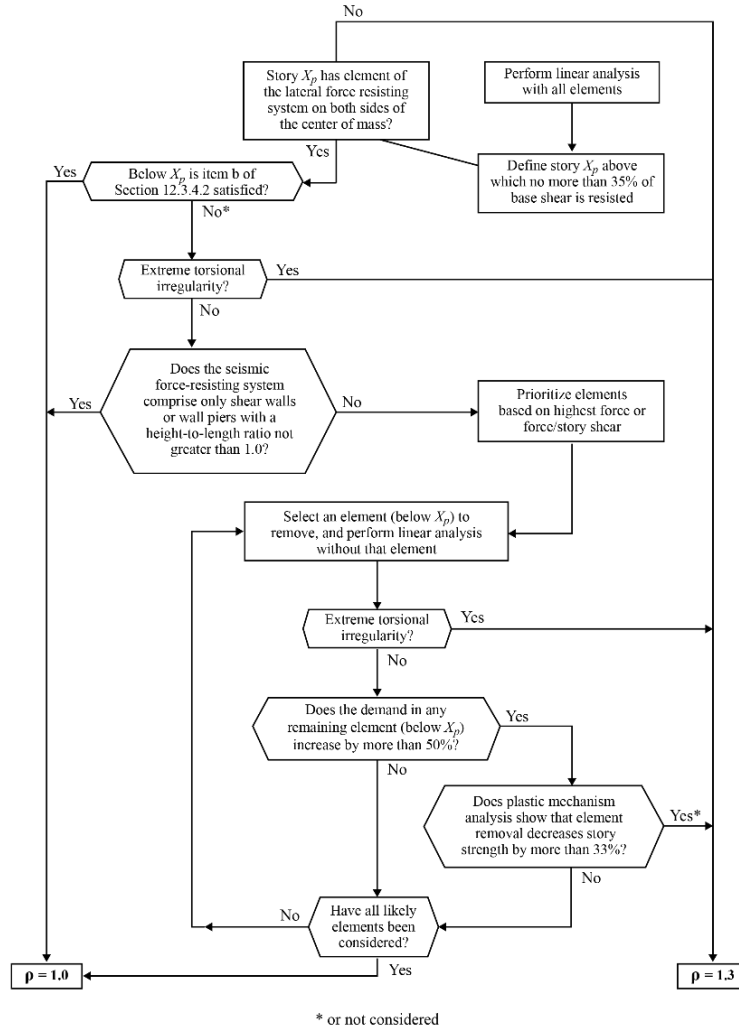

FIGURE C12.3-6 Calculation of the Redundancy Factor, ρ

As indicated in Table 12.3-3, braced frame, moment frame, shear wall, and cantilever column systems must conform to redundancy requirements. Dual systems also are included but, in most cases, are inherently redundant. Shear walls or wall piers with a height-to-length aspect ratio greater than 1.0 within any story have been included; however, the required design of collector elements and their connections for Ω_0 times the design force may address the key issues. To satisfy the collector force requirements, a reasonable number of shear walls usually is required. Regardless, shear wall systems are addressed in this section so that either an adequate number of wall elements is included or the proper redundancy factor is applied. For wall piers, the height is taken as the height of the adjacent opening and generally is less than the story height.

The second approach is a deemed-to-comply condition wherein the structure is regular and has a specified arrangement of seismic force-resisting elements to qualify for a ρ of 1.0. As part of the parametric study, simplified braced frame and moment frame systems were investigated to determine their sensitivity to the analytical redundancy criteria. This simple deemed-to-comply condition is consistent with the results of the study.

C12.4 SEISMIC LOAD EFFECTS AND COMBINATIONS

C12.4.1 Applicability.

Structural elements designated by the engineer as part of the seismic force-resisting system typically are designed directly for seismic load effects. None of the seismic forces associated with the design base shear are formally assigned to structural elements that are not designated as part of the seismic force-resisting system, but such elements must be designed using the load conditions of Section 12.4 and must accommodate the deformations resulting from application of seismic loads.

C12.4.2 Seismic Load Effect.

The seismic load effect includes horizontal and vertical components. The horizontal seismic load effects, E_h , are caused by the response of the structure to horizontal seismic ground motions, whereas the vertical seismic load effects are caused by the response of the structure to vertical seismic ground motions. The basic load combinations in Chapter 2 were duplicated and reformulated in Section 12.4 to clarify the intent of the provisions for the vertical seismic load effect term, E_v .

The concept of using an equivalent static load coefficient applied to the dead load to represent vertical seismic load effects was first introduced in ATC 3-06 (1978), where it was defined as simply $\pm 0.2D$. The load combinations where the vertical seismic load coefficient was to be applied assumed strength design load combinations. Neither ATC 3-06 (1978) nor the early versions of the NEHRP provisions (FEMA 2009a) clearly explained how the values of 0.2 were determined, but it is reasonable to assume that it was based on the judgment of the writers of those documents. It is accepted by the writers of this standard that vertical ground motions do occur and that the value of $\pm 0.2S_{DS}$ was determined based on consensus judgment. Many issues enter into the development of the vertical coefficient, including phasing of vertical ground motion and appropriate R factors, which make determination of a more precise value difficult. Although no specific rationale or logic is provided in editions of the NEHRP provisions (FEMA 2009a) on how the value of $0.2S_{DS}$ was determined, one possible way to rationalize the selection of the $0.2S_{DS}$ value is to recognize that it is equivalent to $(2/3)(0.3)S_{DS}$, where the two-thirds factor represents the often-assumed ratio between the vertical and horizontal components of motion, and the 0.3 factor represents the 30% in the 100% to 30% orthogonal load combination rule used for horizontal motions.

For situations where the vertical component of ground motion is explicitly included in design analysis, the vertical ground motion spectra definition that is provided in Section 11.9 should be used. Following the rationale described above, the alternate vertical ground motion component determined in Section 11.9, S_{av} , is combined with the horizontal component of ground motion by using the 100%–30% orthogonal load combination rule used for horizontal motions resulting in the vertical seismic load effect determined with Eq. (12.4-4b), $E_v = 0.3S_{av}D$.

C12.4.2.1 Horizontal Seismic Load Effect.

Horizontal seismic load effects, E_h , are determined in accordance with Eq. (12.4-3) as $E_h = \rho Q_E$. Q_E is the seismic load effect of horizontal seismic forces from V or F_p . The purpose of E_h is to approximate the horizontal seismic load effect from the design basis earthquake to be used in load combinations including E for the design of lateral force-resisting elements including diaphragms, vertical elements of seismic force-resisting systems as defined in Table 12.2-1, the design and anchorage of elements such as structural walls, and the design of nonstructural components.

C12.4.2.2 Vertical Seismic Load Effect.

The vertical seismic load effect, E_v , is determined with Eq. (12.4-4a) as $E_v = 0.2S_{DS}D$ or with Eq. (12.4-4b) as $E_v = 0.3S_{av}D$. E_v is permitted to be taken as zero in Eqs. (12.4-1), (12.4-2), (12.4-5), and (12.4-6) for structures assigned to Seismic Design Category B and in Eq. (12.4-2) for determining demands on the soil–structure interface of foundations. E_v increases the load on beams and columns supporting seismic elements and increases the axial load in the P–M interaction of walls resisting seismic load effects.

C12.4.3 Seismic Load Effects Including Overstrength.

Some elements of properly detailed structures are not capable of safely resisting ground-shaking demands through inelastic behavior. To ensure safety, these elements must be designed with sufficient strength to remain elastic.

The horizontal load effect including overstrength may be calculated in either of two ways. The load effect may be approximated by use of an overstrength factor, Ω_0 , which approximates the inherent overstrength in typical structures based on the structure’s seismic force-resisting systems. This approach is addressed in Section 12.4.3.1. Alternatively, the expected system strength may be directly calculated based on actual member sizes and expected material properties, as addressed in Section 12.4.3.2.

C12.4.3.1 Horizontal Seismic Load Effect Including Overstrength.

Horizontal seismic load effects including overstrength, E_{mh} , are determined in accordance with Eq. (12.4-7) as $E_{mh} = \Omega_0 Q_E$. Q_E is the effect of horizontal seismic forces from V , F_{px} , or F_p . The purpose for E_{mh} is to approximate the maximum seismic load for the design of critical elements, including discontinuous systems, transfer beams and columns supporting discontinuous systems, and collectors. Forces calculated using this approximate method need not be used if a more rigorous evaluation as permitted in Section 12.4.3.2 is used.

C12.4.3.2 Capacity-Limited Horizontal Seismic Load Effect.

The standard permits the horizontal seismic load effect including overstrength to be calculated directly using actual member sizes and expected material properties where it can be determined that yielding of other elements in the structure limits the force that can be delivered to the element in question. When calculated this way, the horizontal seismic load effect including overstrength is termed the capacity-limited seismic load effect, E_{cl} .

As an example, the axial force in a column of a moment-resisting frame results from the shear forces in the beams that connect to this column. The axial forces caused by seismic loads need never be taken as greater than the sum of the shear forces in these beams at the development of a full structural mechanism, considering the probable strength of the materials and strain-hardening effects. For frames controlled by beam hinge-type mechanisms, these shear forces would typically be calculated as $2M_{pr} / L_h$, where M_{pr} is the probable flexural strength of the beam considering expected material properties and strain hardening, and L_h is the distance between plastic hinge locations. Both ACI 318 and AISC 341 require that beams in special moment frames be designed for shear calculated in this manner, and both standards include many other requirements that represent the capacity-limited seismic load effect instead of the use of a factor approximating overstrength. This design approach is sometimes termed “capacity design.” In this design method, the capacity (expected strength) of one or more elements is used to generate the demand (required strength) for other elements, because the yielding of the former limits the forces delivered to the latter. In this context, the capacity of the yielding element is its expected or mean anticipated strength, considering

potential variation in material yield strength and strain-hardening effects. When calculating the capacity of elements for this purpose, expected member strengths should not be reduced by strength reduction or resistance factors, ϕ .

The capacity-limited design is not restricted to yielding limit states (axial, flexural, or shear); other examples include flexural buckling (axial compression) used in steel special concentrically braced frames, or lateral-torsional buckling in steel ordinary moment frame beams, as confirmed by testing.

C12.4.4 Minimum Upward Force for Horizontal Cantilevers for Seismic Design Categories D through F.

In Seismic Design Categories D, E, and F, horizontal cantilevers are designed for an upward force that results from an effective vertical acceleration of 1.2 times gravity. This design requirement is meant to provide some minimum strength in the upward direction and to account for possible dynamic amplification of vertical ground motions resulting from the vertical flexibility of the cantilever. The requirement is not applied to downward forces on cantilevers, for which the typical load combinations are used.

C12.5 DIRECTION OF LOADING

Seismic forces are delivered to a building through ground accelerations that may approach from any direction relative to the orthogonal directions of the building; therefore, seismic effects are expected to develop in both directions simultaneously. The standard requires structures to be designed for the most critical loading effects from seismic forces applied in any direction. The procedures outlined in this section are deemed to satisfy this requirement.

For horizontal structural elements such as beams and slabs, orthogonal effects may be minimal; however, design of vertical elements of the seismic force-resisting system that participate in both orthogonal directions is likely to be governed by these effects.

C12.5.1 Direction of Loading Criteria.

For structures with orthogonal seismic force-resisting systems, the most critical load effects can typically be computed using a pair of orthogonal directions that coincide with the principal axes of the structure. Structures with nonparallel or nonorthogonal systems may require a set of orthogonal direction pairs to determine the most critical load effects. If a three-dimensional mathematical model is used, the analyst must be attentive to the orientation of the global axes in the model in relation to the principal axes of the structure.

C12.5.2 Seismic Design Category B.

Recognizing that design of structures assigned to Seismic Design Category (SDC) B is often controlled by nonseismic load effects and, therefore, is not sensitive to orthogonal loadings regardless of any horizontal structural irregularities, it is permitted to determine the most critical load effects by considering that the maximum response can occur in any single direction; simultaneous application of response in the orthogonal direction is not required. Typically, the two directions used for analysis coincide with the principal axes of the structure.

C12.5.3 SEISMIC DESIGN CATEGORY C.

Design of structures assigned to SDC C often parallels the design of structures assigned to SDC B and, therefore, as a minimum conforms to Section 12.5.2. Although it is not likely that design of the seismic force-resisting systems in regular structures assigned to SDC C would be sensitive to orthogonal loadings, special consideration must be given to structures with nonparallel or nonorthogonal systems (Type 5 horizontal structural irregularity), and structures with torsional irregularities (Type 1a and 1b horizontal structural irregularity), to avoid overstressing by different directional loadings. In these cases, the standard

provides two methods to approximate simultaneous orthogonal loadings and requires a three-dimensional mathematical model of the structure for analysis in accordance with Section 12.7.3.

The orthogonal combination procedure in item (a) of Section 12.5.3.1 combines the effects from 100% of the seismic load applied in one direction with 30% of the seismic load applied in the perpendicular direction. This general approximation—the “30% rule”—was introduced by Rosenblueth and Contreras (1977) based on earlier work by A. S. Veletsos and also N. M. Newmark (cited in Rosenblueth and Contreras 1977) as an alternative to performing the more rational, yet computationally demanding, response history analysis, and is applicable to any elastic structure. Combining effects for seismic loads in each direction, and accidental torsion in accordance with Sections 12.8.4.2 and 12.8.4.3, results in the following 16 load combinations:

- $Q_E = \pm Q_{E_{X+AT}} \pm 0.3Q_{E_Y}$ where Q_{E_Y} = effect of Y -direction load at the center of mass (Section 12.8.4.2);
- $Q_E = \pm Q_{E_{X-AT}} \pm 0.3Q_{E_Y}$ where Q_{E_X} = effect of X -direction load at the center of mass (Section 12.8.4.2);
- $Q_E = \pm Q_{E_{Y+AT}} \pm 0.3Q_{E_X}$ where AT = accidental torsion computed in accordance with Sections 12.8.4.2 and 12.8.4.3; and
- $Q_E = \pm Q_{E_{Y-AT}} \pm 0.3Q_{E_X}$.

Though the standard permits combining effects from forces applied independently in any pair of orthogonal directions (to approximate the effects of concurrent loading), accidental torsion need not be considered in the direction that produces the lesser effect, per Section 12.8.4.2. This provision is sometimes disregarded when using a mathematical model for three-dimensional analysis that can automatically include accidental torsion, which then results in 32 load combinations.

The maximum effect of seismic forces, Q_E , from orthogonal load combinations is modified by the redundancy factor, ρ , or the overstrength factor, Ω_0 , where required, and the effects of vertical seismic forces, E_v , are considered in accordance with Section 12.4 to obtain the seismic load effect, E .

These orthogonal combinations should not be confused with uniaxial modal combination rules, such as the square root of the sum of the squares (SRSS) or the complete quadratic combination (CQC) method. In past standards, an acceptable alternative to the above was to use the SRSS method to combine effects of the two orthogonal directions, where each term computed is assigned the sign that resulted in the most conservative result. This method is no longer in common use. Although both approaches described for considering orthogonal effects are approximations, it is important to note that they were developed with consideration of results for a square building.

Orthogonal effects can alternatively be considered by performing three-dimensional response history analyses (see Chapter 16) with application of orthogonal ground motion pairs applied simultaneously in any two orthogonal directions. If the structure is located within 3 mi (5 km) of an active fault, the ground motion pair should be rotated to the fault-normal and fault-parallel directions of the causative fault.

C12.5.4 Seismic Design Categories D through F.

The direction of loading for structures assigned to SDCs D, E, or F conforms to Section 12.5.3 for structures assigned to SDC C. If a 1a, 2b, or Type 5 horizontal structural irregularity exists, then orthogonal effects are similarly included in design. Recognizing the higher seismic risk associated with structures assigned to SDCs D, E, or F, the standard provides additional requirements for vertical members coupled between intersecting seismic force-resisting systems.

C12.6 ANALYSIS PROCEDURE SELECTION

This change from ASCE 7-16 is to simplify the selection of the analytical procedure to use in seismic design. Equivalent Lateral Force Procedure (Section 12.8), Modal Response Spectrum Analysis (Section 12.9.1) and Linear Response History Analysis (section 12.9.2) are all equally accepted procedures. The designer can select the procedure best suited to the building design needs. The ELF, MRSA and LRHA procedures are not applicable to buildings with seismic isolation or buildings with passive energy dissipation devices since these systems have unique analytical procedures.

The modal response analysis and linear response history analysis procedures can provide excellent representations of the linear dynamic seismic response of buildings to a single input ground motion. Extending these linear procedures to multiple ground motions by way of design spectral values, and including inelastic effects with spectral reductions for inelasticity, R , are not as reliable. (FEMA P-2082 (2020), Maniatakis 2013, Pugh 2017, Sanchez 2019, and Tauberg 2019)

BSSC PUC Issue Team 3 was formed to study various improvements of Modal Response Spectrum Analysis procedure for code level design analyses. The results of those studies are presented in Resource Paper on Modal Response Spectrum Analysis -- FEMA P-2082 (2020). A major conclusion of the paper states that the equivalent lateral force (ELF) analyses provides more consistent story shear, overturning moment and story drift results than modal response spectral analyses when compared to nonlinear dynamic response at the design level earthquakes. FEMA P-2012 (2018) study found that using the MRSA approach for torsional irregular buildings must include accidental torsion effects through added torsional forces rather than by shifting the mass to estimate the torsional effect (ASCE 7-16, Supplement 2). The engineer should be aware that ELF, MRSA and LRHA procedures have not been compared with nonlinear response analyses for all vertical and plan irregularities and combinations in Tables 12.3-1 and 12.3-2, let alone for all possible configurations of structures. There may be unusual situations where MRSA design values exceed those of ELF. There are reasons the engineer may wish to use MRSA rather than ELF. Unique structural configurations with long spans, dynamically sensitive or irregular mass distributions are examples. The engineer is expected to use judgement regarding the use of appropriate analysis methodology under those circumstances.

The structural modeling requirements (ASCE 7-16, Section 12.7.3) are the same for all three linear analysis procedures. The only difference is that the MRSA and LRHA procedures require a minimum of three dynamic degrees of freedom in all models, while this requirement is required by ELF analysis for horizontal structural irregularities Type 1a, 1b, 4 or 5 of Table 12.3-1.

C12.7 MODELING CRITERIA

C12.7.1 Foundation Modeling.

Structural systems consist of three interacting subsystems: the structural framing (girders, columns, walls, and diaphragms), the foundation (footings, piles, and caissons), and the supporting soil. The ground motion that a structure experiences, as well as the response to that ground motion, depends on the complex interaction among these subsystems.

Those aspects of ground motion that are affected by site characteristics are assumed to be independent of the structure–foundation system because these effects would occur in the free field in the absence of the structure. Hence, site effects are considered separately (Sections 11.4.3 through 11.4.5 and Chapters 20 and 21).

Given a site-specific ground motion or response spectrum, the dynamic response of the structure depends on the foundation system and on the characteristics of the soil that support the system. The dependence of the response on the structure–foundation–soil system is referred to as soil–structure interaction (SSI). Such interactions usually, but not always, result in a reduction of seismic base shear. This reduction is caused by the flexibility of the foundation–soil system and an associated lengthening of the fundamental period of

vibration of the structure. In addition, the soil system may provide an additional source of damping. However, that total displacement typically increases with soil–structure interaction.

If the foundation is considered to be rigid, the computed base shears are usually conservative, and it is for this reason that rigid foundation analysis is permitted. The designer may neglect soil–structure interaction or may consider it explicitly in accordance with Section 12.13.3 or implicitly in accordance with Chapter 19.

As an example, consider a moment-frame building without a basement and with moment-frame columns supported on footings designed to support shear and axial loads (i.e., pinned column bases). If foundation flexibility is not considered, the columns should be restrained horizontally and vertically, but not rotationally. Consider a moment-frame building with a basement. For this building, horizontal restraint may be provided at the level closest to grade, as long as the diaphragm is designed to transfer the shear out of the moment frame. Because the columns extend through the basement, they may also be restrained rotationally and vertically at this level. However, it is often preferable to extend the model through the basement and provide the vertical and rotational restraints at the foundation elements, which is more consistent with the actual building geometry.

C12.7.2 Effective Seismic Weight.

During an earthquake, the structure accelerates laterally, and these accelerations of the structural mass produce inertial forces. These inertial forces, accumulated over the height of the structure, produce the seismic base shear.

When a building vibrates during an earthquake, only that portion of the mass or weight that is physically tied to the structure needs to be considered as effective. Hence, live loads (e.g., loose furniture, loose equipment, and human occupants) need not be included. However, certain types of live loads, such as storage loads, may develop inertial forces, particularly where they are densely packed.

Also considered as contributing to effective seismic weight are the following:

1. All permanent equipment (e.g., air conditioners, elevator equipment, and mechanical systems);
2. Partitions to be erected or rearranged as specified in Section 4.3.2 (greater of actual partition weight and 10 lb/ft^2 (0.5 kN/m^2) of floor area);
3. 20% of significant snow load, $p_f > 30 \text{ lb/ft}^2$ ($p_f > 1.4 \text{ kN/m}^2$) and
4. The weight of landscaping and similar materials.

The full snow load need not be considered because maximum snow load and maximum earthquake load are unlikely to occur simultaneously and loose snow does not move with the roof.

C12.7.3 Structural Modeling.

The development of a mathematical model of a structure is always required because the story drifts and the design forces in the structural members cannot be determined without such a model. In some cases, the mathematical model can be as simple as a free-body diagram as long as the model can appropriately capture the strength and stiffness of the structure.

The most realistic analytical model is three-dimensional, includes all sources of stiffness in the structure and the soil–foundation system as well as P-delta effects, and allows for nonlinear inelastic behavior in all parts of the structure–foundation–soil system. Development of such an analytical model is time-consuming, and such analysis is rarely warranted for typical building designs performed in accordance with the standard. Instead of performing a nonlinear analysis, inelastic effects are accounted for indirectly in the linear analysis methods by means of the response modification coefficient, R , and the deflection amplification factor, C_d

Using modern software, it often is more difficult to decompose a structure into planar models than it is to develop a full three-dimensional model, so three-dimensional models are now commonplace. Increased computational efficiency also allows efficient modeling of diaphragm flexibility. Three-dimensional models are required where the structure has horizontal torsional (Type 1), out-of-plane offset (Type 4), or nonparallel system (Type 5) irregularities.

Analysis using a three-dimensional model is not required for structures with flexible diaphragms that have horizontal out-of-plane offset irregularities. It is not required because the irregularity imposes seismic load effects in a direction other than the direction under consideration (orthogonal effects) because of eccentricity in the vertical load path caused by horizontal offsets of the vertical lateral force-resisting elements from story to story. This situation is not likely to occur, however, with flexible diaphragms to an extent that warrants such modeling. The eccentricity in the vertical load path causes a redistribution of seismic design forces from the vertical elements in the story above to the vertical elements in the story below in essentially the same direction. The effect on the vertical elements in the orthogonal direction in the story below is minimal. Three-dimensional modeling may still be required for structures with flexible diaphragms caused by other types of horizontal irregularities (e.g., nonparallel system).

In general, the same three-dimensional model may be used for the equivalent lateral force, the modal response spectrum, and the linear response history analysis procedures. Modal response spectrum and linear response history analyses require a realistic modeling of structural mass; the response history method also requires an explicit representation of inherent damping. 5% of critical damping is automatically included in the modal response spectrum approach. Chapter 16 and the related commentary have additional information on linear and nonlinear response history analysis procedures.

It is well known that deformations in the panel zones of the beam–column joints of steel moment frames are a significant source of flexibility. Two different mechanical models for including such deformations are summarized in Charney and Marshall (2006). These methods apply to both elastic and inelastic systems. For elastic structures, centerline analysis provides reasonable, but not always conservative, estimates of frame flexibility. Fully rigid end zones should not be used because this method always results in an overestimation of lateral stiffness in steel moment-resisting frames. Partially rigid end zones may be justified in certain cases, such as where doubler plates are used to reinforce the panel zone.

Including the effect of composite slabs in the stiffness of beams and girders may be warranted in some circumstances. Where composite behavior is included, due consideration should be paid to the reduction in effective composite stiffness for portions of the slab in tension (Schaffhausen and Wegmuller 1977, Liew et al. 2001).

For reinforced concrete buildings, it is important to address the effects of axial, flexural, and shear cracking in modeling the effective stiffness of the structural elements. Determining appropriate effective stiffness of the structural elements should take into consideration the anticipated demands on the elements, their geometry, and the complexity of the model. Recommendations for computing cracked section properties may be found in Paulay and Priestley (1992) and similar texts.

When dynamic analysis is performed, at least three dynamic degrees of freedom must be present at each level consistent with language in Section 16.2.2. Depending on the analysis software and modal extraction technique used, dynamic degrees of freedom and static degrees of freedom are not identical. It is possible to develop an analytical model that has many static degrees of freedom but only one or two dynamic degrees of freedom. Such a model does not capture response properly.

C12.7.4 Interaction Effects.

The interaction requirements are intended to prevent unexpected failures in members of moment-resisting frames. Figure C12.7-1 illustrates a typical situation where masonry infill is used and this masonry is fitted tightly against reinforced concrete columns. Because the masonry is much stiffer than the columns, hinges in a column form at the top of the column and at the top of the masonry rather than at the top and bottom

of the column. If the column flexural capacity is M_p , the shear in the columns increases by the factor H/h , and this increase may cause an unexpected nonductile shear failure in the columns. Many building collapses have been attributed to this effect.

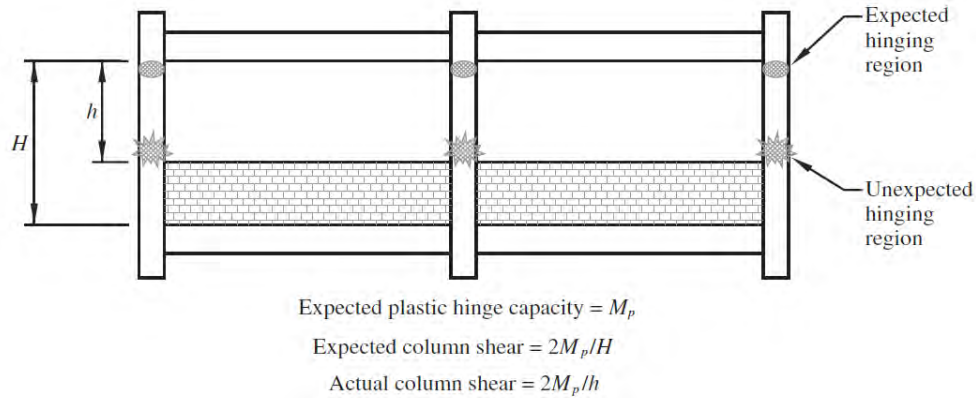

FIGURE C12.7-1 Undesired Interaction Effects

C12.8 EQUIVALENT LATERAL FORCE PROCEDURE

The equivalent lateral force (ELF) procedure provides a simple way to incorporate the effects of inelastic dynamic response into a linear static analysis. This procedure is useful in preliminary design of all structures and is allowed for final design of the vast majority of structures. The procedure is valid only for structures without significant discontinuities in mass and stiffness along the height, where the dominant response to ground motions is in the horizontal direction without significant torsion.

The ELF procedure has three basic steps:

1. Determine the seismic base shear, V ;
2. Distribute V vertically along the height of the structure; and
3. Distribute V horizontally across the width and breadth of the structure.

Each of these steps is based on a number of simplifying assumptions. A broader understanding of these assumptions may be obtained from any structural dynamics textbook that emphasizes seismic applications.

C12.8.1 Seismic Base Shear.

Treating the structure as a single-degree-of-freedom system with 100% mass participation in the fundamental mode, Eq. (12.8-1) simply expresses V as the product of the effective seismic weight, W , and the seismic response coefficient, C_s , which is a period-dependent, spectral pseudoacceleration, in g units. C_s is modified by the response modification coefficient, R , and the Importance Factor, I_e , as appropriate, to account for inelastic behavior and to provide for improved performance for high-occupancy or essential structures.

C12.8.1.1 Calculation of Seismic Response Coefficient.

The standard prescribes five equations for determining C_s . Eqs. (12.8-2), (12.8-3), and (12.8-4) are illustrated in Figure C12.8-1.

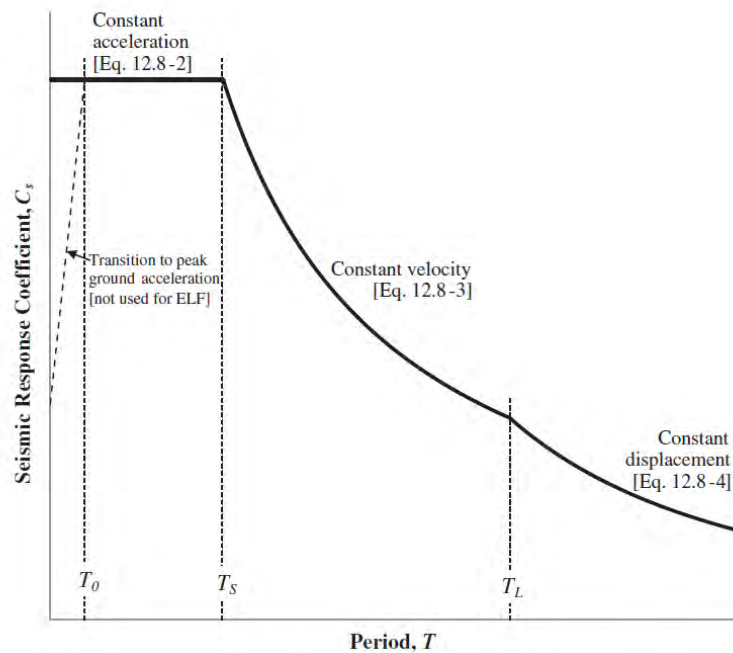

FIGURE C12.8-1 Seismic Response Coefficient Versus Period

Eq. (12.8-2) controls where $0.0 < T < T_s$ and represents the constant acceleration part of the design response spectrum (Section 11.4.5). In this region, C_s is independent of period. Although the theoretical design response spectrum shown in Figure 11.4-1 illustrates a transition in pseudoacceleration to the peak ground acceleration as the fundamental period, T , approaches zero from T_0 , this transition is not used in the ELF procedure. One reason is that simple reduction of the response spectrum by $(1/R)$ in the short-period region would exaggerate inelastic effects.

Eq. (12.8-3), representing the constant velocity part of the spectrum, controls where $T_s < T < T_L$. In this region, the seismic response coefficient is inversely proportional to period, and the pseudovelocity (pseudoacceleration divided by circular frequency, ω , assuming steady-state response) is constant. T_L , the long-period transition period, represents the transition to constant displacement and is provided in Figs. 22-12 through 22-16. T_L ranges from 4 s in the north-central conterminous states and western Hawaii to 16 s in the Pacific Northwest and in western Alaska.

Eq. (12.8-4), representing the constant displacement part of the spectrum, controls where $T > T_L$. Given the current mapped values of T_L , this equation only affects long-period structures. The transition period has recently received increased attention because displacement response spectra from the 2010 magnitude 8.8 Chilean earthquake indicate that a considerably lower transition period is possible in locations controlled by subduction zone earthquakes.

The final two equations represent minimum base shear levels for design. Eq. (12.8-5) is the minimum base shear and primarily affects sites in the far field. This equation provides an allowable strength of approximately 3% of the weight of the structure. This minimum base shear was originally enacted in 1933 by the state of California (Riley Act). Based on research conducted in the ATC-63 project (FEMA 2009b),

it was determined that this equation provides an adequate level of collapse resistance for long-period structures when used in conjunction with other provisions of the standard.

Eq. (12.8-6) applies to sites near major active faults (as reflected by values of S_1) where pulse-type effects can increase long-period demands.

C12.8.1.2 Soil–Structure Interaction Reduction.

Soil–structure interaction, which can significantly influence the dynamic response of a structure during an earthquake, is addressed in Chapter 19.

C12.8.1.3 Maximum S_{DS} Value in Determination of C_s and E_v .

This cap on the maximum value of S_{DS} reflects engineering judgment about performance of code-complying, regular, low-rise buildings in past earthquakes. It was created during the update from the 1994 UBC to the 1997 UBC and has been carried through to this standard. At that time, near-source factors were introduced, which increased the design force for buildings in Zone 4, which is similar to Seismic Design Categories D through F in this standard. The near-source factor was based on observations of instrument recording during the 1994 Northridge earthquake and new developments in seismic hazard and ground motion science. The cap placed on S_{DS} for design reflected engineering judgment by the SEAOC Seismology Committee about performance of code-complying low-rise structures based on anecdotal evidence from past California earthquakes, specifically the 1971 San Fernando, 1989 Loma Prieta, and 1994 Northridge earthquakes.

In the 1997 UBC, the maximum reduction of the cap provided was 30%. Since the change from seismic zones in the 1997 UBC to probabilistic and deterministic seismic hazard in ASCE 7-02 (2003) and subsequent editions, S_{DS} values in some parts of the country can exceed $S_{DS} = 2.0$, creating reductions well beyond the original permitted reduction. That is the rationale for this provision providing a maximum reduction in design force of 30%.

The structural height, period, redundancy, and regularity conditions required for use of the limit are important qualifiers. Additionally, the observations of acceptable performance have been with respect to collapse and life safety, not damage control or preservation of function, so this cap on the design force is limited to Risk Category I and II structures, not Risk Category III and IV structures, where higher performance is expected. Also, because past earthquake experience has indicated that buildings on very soft soils, Site Classes E and F, have performed noticeably more poorly than buildings on more competent ground, this cap cannot be used on those sites.

C12.8.2 Period Determination.

The fundamental period, T , for an elastic structure is used to determine the design base shear, V , as well as the exponent, k , that establishes the distribution of V along the height of the structure (see Section 12.8.3). T may be computed using a mathematical model of the structure that incorporates the requirements of Section 12.7 in a properly substantiated analysis. Generally, this type of analysis is performed using a computer program that incorporates all deformational effects (e.g., flexural, shear, and axial) and accounts for the effect of gravity load on the stiffness of the structure. For many structures, however, the sizes of the primary structural members are not known at the outset of design. For preliminary design, as well as instances where a substantiated analysis is not used, the standard provides formulas to compute an approximate fundamental period, T_a (see Section 12.8.2.1). These periods represent lower-bound estimates of T for different structure types. Period determination is typically computed for a mathematical model that is fixed at the base. That is, the base where seismic effects are imparted into the structure is globally restrained (e.g., horizontally, vertically, and rotationally). Column base modeling (i.e., pinned or fixed) for frame-type seismic force-resisting systems is a function of frame mechanics, detailing, and foundation (soil) rigidity; attention should be given to the adopted assumption. However, this conceptual restraint is not the

same for the structure as is stated above. Soil flexibility may be considered for computing T (typically assuming a rigid foundation element). The engineer should be attentive to the equivalent linear soil-spring stiffness used to represent the deformational characteristics of the soil at the base (see Section 12.13.3). Similarly, pinned column bases in frame-type structures are sometimes used to conservatively account for soil flexibility under an assumed rigid foundation element. Period shifting of a fixed-base model of a structure caused by soil–structure interaction is permitted in accordance with Chapter 19.

The fundamental mode of a structure with a geometrically complex arrangement of seismic force-resisting systems determined with a three-dimensional model may be associated with the torsional mode of response of the system, with mass participating in both horizontal directions (orthogonal) concurrently. The analyst must be attentive to this mass participation and recognize that the period used to compute the design base shear should be associated to the mode with the largest mass participation in the direction being considered. Often in this situation, these periods are close to each other. Significant separation between the torsional mode period (when fundamental) and the shortest translational mode period may be an indicator of an ill-conceived structural system or potential modeling error. The standard requires that the fundamental period, T , used to determine the design base shear, V , does not exceed the approximate fundamental period, T_a , times the upper limit coefficient, C_u , provided in Table 12.8-1. This period limit prevents the use of an unusually low base shear for design of a structure that is, analytically, overly flexible because of mass and stiffness inaccuracies in the analytical model. C_u has two effects on T_a . First, recognizing that project-specific design requirements and design assumptions can influence T , C_u lessens the conservatism inherent in the empirical formulas for T_a to more closely follow the mean curve (Figure C12.8-2). Second, the values for C_u recognize that the formulas for T_a are targeted to structures in high seismic hazard locations. The stiffness of a structure is most likely to decrease in areas of lower seismicity, and this decrease is accounted for in the values of C_u . The response modification coefficient, R , typically decreases to account for reduced ductility demands, and the relative wind effects increase in lower seismic hazard locations. The design engineer must therefore be attentive to the value used for design of seismic force-resisting systems in structures that are controlled by wind effects. Although the value for C_u is most likely to be independent of the governing design forces in high wind areas, project-specific serviceability requirements may add considerable stiffness to a structure and decrease the value of C_u from considering seismic effects alone. This effect should be assessed where design forces for seismic and wind effects are almost equal. Lastly, if T from a properly substantiated analysis (Section 12.8.2) is less than $C_u T_a$, then the lower value of T and $C_u T_a$ should be used for the design of the structure.

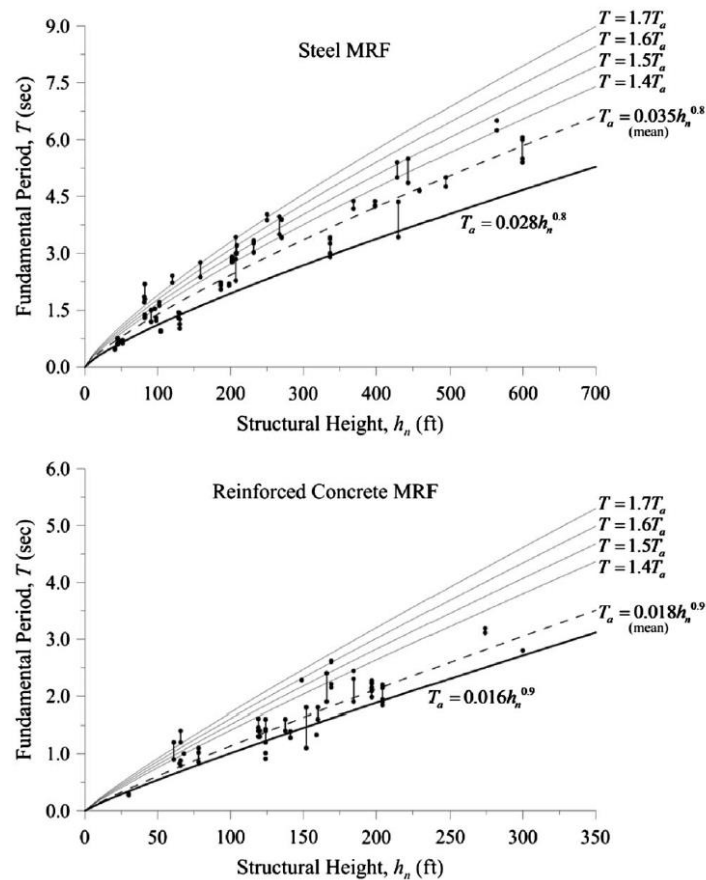

FIGURE C12.8-2 Variation of Fundamental Period with Structural Height

C12.8.2.1 Approximate Fundamental Period.

Eq. (12.8-7) is an empirical relationship determined through statistical analysis of the measured response of building structures in small- to moderate-sized earthquakes, including response to wind effects (Goel and Chopra 1997, 1998). Figure C12.8-2 illustrates such data for various building structures with steel and reinforced concrete moment-resisting frames. Historically, the exponent, α , in Eq. (12.8-7) has been taken as 0.75 and was based on the assumption of a linearly varying mode shape while using Rayleigh's method. The exponents provided in the standard, however, are based on actual response data from building structures, thus more accurately reflecting the influence of mode shape on the exponent. Because the empirical expression is based on the lower bound of the data, it produces a lower bound estimate of the period for a building structure of a given height. This lower bound period, when used in Eqs. (12.8-3) and (12.8-4) to compute the seismic response coefficient, C_S , provides a conservative estimate of the seismic base shear, V .

C12.8.3 Vertical Distribution of Seismic Forces.

Eq. (12.8-12) is based on the simplified first mode shape shown in Figure C12.8-3. In the Figure, F_x is the inertial force at level x , which is simply the absolute acceleration at level x times the mass at level x . The base shear is the sum of these inertial forces, and Eq. (12.8-11) simply gives the ratio of the lateral seismic force at level x , F_x , to the total design lateral force or shear at the base, V .

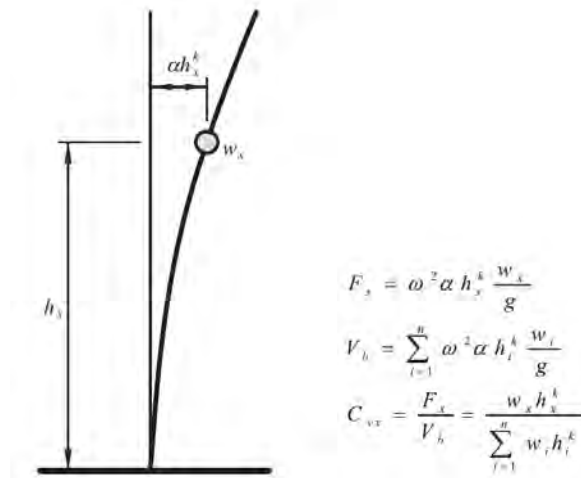

FIGURE C12.8-3 Basis of Eq. (12.8-12)

The deformed shape of the structure in Figure C12.8-3 is a function of the exponent k , which is related to the fundamental period of the structure, T . The variation of k with T is illustrated in Figure C12.8-4. The exponent k is intended to approximate the effect of higher modes, which are generally more dominant in structures with a longer fundamental period of vibration. Lopez and Cruz (1996) discuss the factors that influence higher modes of response. Although the actual first mode shape for a structure is also a function of the type of seismic force-resisting system, that effect is not reflected in these equations. Also, because T is limited to $C_u T_a$ for design, this mode shape may differ from that corresponding to the statistically based empirical formula for the approximate fundamental period, T_a . A drift analysis in accordance with Section 12.8.6 can be conducted using the actual period (see Section C12.8.6). As such, k changes to account for the variation between T and the actual period.

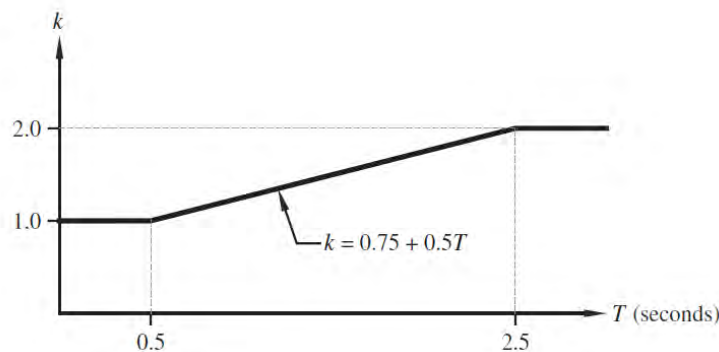

FIGURE C12.8-4 Variation of Exponent k with Period T

The horizontal forces computed using Eq. (12.8-11) do not reflect the actual inertial forces imparted on a structure at any particular point in time. Instead, they are intended to provide lateral seismic forces at individual levels that are consistent with enveloped results from more accurate analyses (Chopra and Newmark 1980).

C12.8.4 Horizontal Distribution of Forces.

Within the context of an ELF analysis, the horizontal distribution of lateral forces in a given story to various seismic force-resisting elements in that story depends on the type, geometric arrangement, and vertical extents of the structural elements and on the shape and flexibility of the floor or roof diaphragm. Because some elements of the seismic force-resisting system are expected to respond inelastically to the design ground motion, the distribution of forces to the various structural elements and other systems also depends on the strength of the yielding elements and their sequence of yielding (see Section C12.1.1). Such effects cannot be captured accurately by a linear elastic static analysis (Paulay 1997), and a nonlinear dynamic analysis is too computationally cumbersome to be applied to the design of most buildings. As such, approximate methods are used to account for uncertainties in horizontal distribution in an elastic static analysis, and to a lesser extent in elastic dynamic analysis.

Of particular concern in regard to the horizontal distribution of lateral forces is the torsional response of the structure during the earthquake. The standard requires that the inherent torsional moment be evaluated for every structure with diaphragms that are not flexible (see Section C12.8.4.1). Although primarily a factor for torsionally irregular structures, this mode of response has also been observed in structures that are designed to be symmetric in plan and layout of seismic force-resisting systems (De La Llera and Chopra 1994). This torsional response in the case of a torsionally regular structure is caused by a variety of “accidental” torsional moments caused by increased eccentricities between the centers of rigidity and mass that exist because of uncertainties in quantifying the mass and stiffness distribution of the structure, as well as torsional components of earthquake ground motion that are not included explicitly in code-based designs (Newmark and Rosenblueth 1971). Consequently, the accidental torsional moment can affect any structure, and potentially more so for a torsionally irregular structure. The standard requires that the accidental torsional moment be considered for every structure (see Section C12.8.4.2) as well as the amplification of this torsion for structures with torsional irregularity (see Section C12.8.4.3).

C12.8.4.1 Inherent Torsion.

Where a rigid diaphragm is in the analytical model, the mass tributary to that floor or roof can be idealized as a lumped mass located at the resultant location on the floor or roof—termed the center of mass (CoM). This point represents the resultant of the inertial forces on the floor or roof. This diaphragm model simplifies structural analysis by reducing what would be many degrees of freedom in the two principal directions of a structure to three degrees of freedom (two horizontal and one rotational about the vertical axis). Similarly, the resultant stiffness of the structural members providing lateral stiffness to the structure tributary to a given floor or roof can be idealized as the center of rigidity (CoR).

It is difficult to accurately determine the center of rigidity for a multistory building because the center of rigidity for a particular story depends on the configuration of the seismic force-resisting elements above and below that story and may be load dependent (Chopra and Goel 1991). Furthermore, the location of the CoR is more sensitive to inelastic behavior than the CoM. If the CoM of a given floor or roof does not coincide with the CoR of that floor or roof, an inherent torsional moment, M_t , is created by the eccentricity between the resultant seismic force and the CoR. In addition to this *idealized* inherent torsional moment, the standard requires that an accidental torsional moment, M_{ta} , be considered (see Section C12.8.4.2).

Similar principles can be applied to models of semirigid diaphragms that explicitly model the in-plane stiffness of the diaphragm, except that the deformation of the diaphragm needs to be included in computing the distribution of the resultant seismic force and inherent torsional moment to the seismic force-resisting system.

This inherent torsion is included automatically when performing a three-dimensional analysis using either a rigid or semirigid diaphragm. If a two-dimensional planar analysis is used, where permitted, the CoR and CoM for each story must be determined explicitly and the applied seismic forces must be adjusted accordingly.

For structures with flexible diaphragms (as defined in Section 12.3), vertical elements of the seismic force-resisting system are assumed to resist inertial forces from the mass that is tributary to the elements with no explicitly computed torsion. No diaphragm is perfectly flexible; therefore some torsional forces develop even when they are neglected.

C12.8.4.2 Accidental Torsion.

The locations of the centers of mass and rigidity for a given floor or roof typically cannot be established with a high degree of accuracy because of mass and stiffness uncertainty and deviations in design, construction, and loading from the idealized case. To account for this inaccuracy, the standard requires the consideration of a minimum eccentricity of 5% of the width of a structure perpendicular to the direction being considered to any static eccentricity computed using idealized locations of the centers of mass and rigidity. Where a structure has a geometrically complex or nonrectangular floor plan, the eccentricity is computed using the diaphragm extents perpendicular to the direction of loading (see Section C12.5).

One approach to account for this variation in eccentricity is to shift the CoM each way from its calculated location and apply the seismic lateral force at each shifted location as separate seismic load cases. It is typically conservative to assume that the CoM offsets at all floors and roof occur simultaneously and in the same direction. This offset produces an “accidental” static torsional moment, M_{ta} , at each story. Most computer programs can automate this offset for three-dimensional analysis by automatically applying these static moments in the autogenerated seismic load case (along the global coordinate axes used in the computer model—see Section C12.5). Alternatively, user-defined torsional moments can be applied as separate load cases and then added to the seismic lateral force load case. For two-dimensional analysis, the accidental torsional moment is distributed to each seismic force-resisting system as an applied static lateral force in proportion to its relative elastic lateral stiffness and distance from the CoR.

Shifting the CoM is a static approximation and thus does not affect the dynamic characteristics of the structure, as would be the case were the CoM to be physically moved by, for example, altering the horizontal mass distribution and mass moment of inertia. Although this “dynamic” approach can be used to adjust the eccentricity, it can be too computationally cumbersome for static analysis and therefore is reserved for dynamic analysis (see Section C12.9.1.5).

The previous discussion is applicable only to a rigid diaphragm model. A similar approach can be used for a semirigid diaphragm model except that the accidental torsional moment is decoupled into nodal moments or forces that are placed throughout the diaphragm. The amount of nodal action depends on how sensitive the diaphragm is to in-plane deformation. As the in-plane stiffness of the diaphragm decreases, tending toward a flexible diaphragm, the nodal inputs decrease proportionally.

The physical significance of this mass eccentricity should not be confused with the physical meaning of the eccentricity required for representing nonuniform wind pressures acting on a structure. However, this accidental torsion also incorporates to a lesser extent the potential torsional motion input into structures with large footprints from differences in ground motion within the footprint of the structure.

Torsionally irregular structures whose fundamental mode is potentially dominated by the torsional mode of response can be more sensitive to dynamic amplification of this accidental torsional moment. Consequently, the 5% minimum can underestimate the accidental torsional moment. In these cases, the standard requires the amplification of this moment for design when using an elastic static analysis procedure, including satisfying the drift limitations (see Section C12.8.4.3).

Accidental torsion results in forces that are combined with those obtained from the application of the seismic design story shears, V_x , including inherent torsional moments. All elements are designed for the maximum effects determined, considering positive accidental torsion, negative accidental torsion, and no accidental torsion (see Section C12.5). Where consideration of earthquake forces applied concurrently in any two orthogonal directions is required by the standard, it is permitted to apply the 5% eccentricity of the

center of mass along the single orthogonal direction that produces the greater effect, but it need not be applied simultaneously in the orthogonal direction.

The exception in this section provides relief from accidental torsion requirements for buildings that are deemed to be relatively insensitive to torsion. It is supported by research (Debock et al. 2014) that compared the collapse probability (using nonlinear dynamic response history analysis) of buildings designed with and without accidental torsion requirements. The research indicated that, while accidental torsion requirements are important for most torsionally sensitive buildings (i.e., those with plan torsional irregularities arising from torsional flexibility or irregular plan layout), and especially for buildings in Seismic Design Category D, E or F, the implementation of accidental torsion provisions has little effect on collapse probability for Seismic Design Category B buildings without Type 1b horizontal structural irregularity and for Seismic Design Category D buildings without Type 1a or 1b irregularity.

C12.8.4.3 Amplification of Accidental Torsional Moment.

For structures with torsional or extreme torsional irregularity (Type 1a or 1b horizontal structural irregularity) analyzed using the equivalent lateral force procedure, the standard requires amplification of the accidental torsional moment to account for increases in the torsional moment caused by potential yielding of the perimeter seismic force-resisting systems (i.e., shifting of the center of rigidity), as well as other factors potentially leading to dynamic torsional instability. For verifying torsional irregularity requirements in Table 12.3-1, story drifts resulting from the applied loads, which include both the inherent and accidental torsional moments, are used with no amplification of the accidental torsional moment ($A_x=1$). The same process is used when computing the amplification factor, A_x , except that displacements (relative to the base) at the level being evaluated are used in lieu of story drifts. Displacements are used here to indicate that amplification of the accidental torsional moment is primarily a system-level phenomenon, proportional to the increase in acceleration at the extreme edge of the structure, and not explicitly related to an individual story and the components of the seismic force-resisting system contained therein.

Eq. (12.8-14) was developed by the SEAOC Seismology Committee to encourage engineers to design buildings with good torsional stiffness; it was first introduced in the UBC (1988). Figure C12.8-5 illustrates the effect of Eq. (12.8-14) for a symmetric rectangular building with various aspect ratios (L/B) where the seismic force-resisting elements are positioned at a variable distance (defined by α) from the center of mass in each direction. Each element is assumed to have the same stiffness. The structure is loaded parallel to the short direction with an eccentricity of $0.05L$.

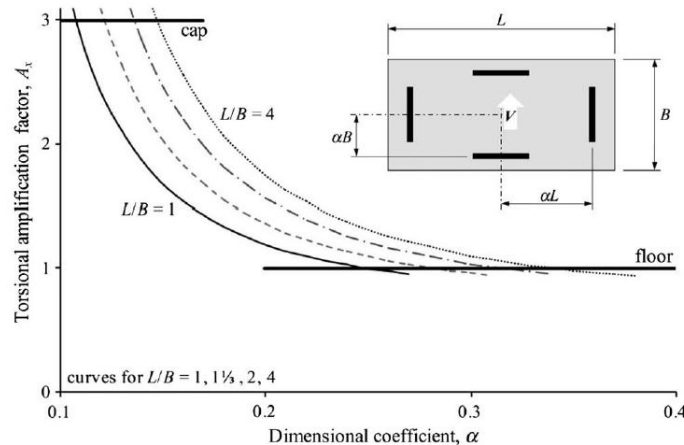

FIGURE C12.8-5 Torsional Amplification Factor for Symmetric Rectangular Buildings

For α equal to 0.5, these elements are at the perimeter of the building, and for α equal to 0.0, they are at the center (providing no torsional resistance). For a square building ($L/B = 1.00$), A_x is greater than 1.0 where α is less than 0.25 and increases to its maximum value of 3.0 where α is equal to 0.11. For a rectangular building with L/B equal to 4.00, A_x is greater than 1.0 where α is less than 0.34 and increases to its maximum value of 3.0 where α is equal to 0.15.

C12.8.5 Overturning.

The overturning effect on a vertical lateral force-resisting element is computed based on the calculation of lateral seismic force, F_x , times the height from the base to the level of the horizontal lateral force-resisting element that transfers F_x to the vertical element, summed over each story. Each vertical lateral force-resisting element resists its portion of overturning based on its relative stiffness with respect to all vertical lateral force-resisting elements in a building or structure. The seismic forces used are those from the equivalent lateral force procedure determined in Section 12.8.3 or based on a dynamic analysis of the building or structure. The overturning forces may be resisted by dead loads and can be combined with dead and live loads or other loads, in accordance with the load combinations of Section 2.3.7.

C12.8.6 Displacement and Drift Determination.

This section defines three types of displacement or drift: the Design Earthquake Displacement [δ_{DE}]; the Maximum Considered Earthquake Displacement [δ_{MCE}]; and the Design Story Drift [Δ].

The Design Earthquake Displacement corresponds to the design earthquake. It is used for structural separations and deformation compatibility and is computed at the location of the element being evaluated. (Previous editions referred to this quantity as the “maximum inelastic response displacement.”) There is thus a Design Earthquake Displacement at every point in the structure, although evaluations using this quantity are not required at every location. The Design Earthquake Displacement is used for structural separation (Section 12.12.3); deformation compatibility (Section 12.12.5); and nonstructural components (Section 13.3.2).

The Design Earthquake Displacement includes diaphragm deformation and rotation, as center-of-mass displacement could significantly underestimate displacement at the building corners and perimeter, and at non-rigid diaphragm locations away from the vertical elements of the seismic force-resisting system. (See Figure C12.8-1) The diaphragm deformation corresponding to the design earthquake is required to be used. (The diaphragm deformation is represented by the term δ_{di} ; diaphragm deformation is therefore not included in the elastic displacement δ_e , which includes displacement and diaphragm-rotation effects of the seismic force-resisting system.) The engineer may determine that the diaphragm remains elastic under the expected demands or may use rational methods of estimating its inelastic deformation; the engineer may determine that amplification by the system C_d factor is the appropriate method. C12.10.3.5 provides guidance on force-displacement characteristics of diaphragms.

Maximum Considered Earthquake Displacement is used for members spanning between structures (Section 12.12.4). The Maximum Considered Earthquake Displacement corresponds to the ground motion displacement and is similar to the Design Earthquake Displacement with two differences:

1. Displacement calculations include a factor of 1.5. This factor corrects for the two-thirds factor that is used in the calculation of seismic base shear, to reduce the base shear from the value based on the ground motion (Section 11.4.4).
2. Displacements are calculated by multiplying elastic displacements by the response reduction coefficient R rather than the displacement amplification factor C_d . Multiplying by R corrects for the fact that values of R less than 1 may substantially underestimate displacements for many seismic-force-resisting systems (Uang and Maarouf 1994). The degree of such underestimation and its

variation among the various types of seismic-force-resisting systems is not known, and is substituted for in this provision pending more detailed information.

Design Story Drift [Δ] is a single representative value of interstory drift at each story corresponding to the design earthquake. The Design Story Drift is calculated as the difference in Design Earthquake Displacements at the center of mass at each story (or at the diaphragm edge for torsionally irregular structures; see Figure C12.8-1). For buildings with flexible diaphragms, the additional displacement at the reference location due to diaphragm deformation is allowed to be neglected, making the Design Story Drift calculation consistent with previous editions of the standard. In such cases, the Design Story Drift is inconsistent with the Design Earthquake Displacement, with implications addressed below. The Design Story Drift is used for comparison to allowable drift (Section 12.12.1) and for the calculation of the stability coefficient (Section 12.8.7).

Figure C12.8-1 shows the determination of the Design Earthquake Displacement and the Design Story Drift. In the plan view, three different Design Earthquake Displacements are shown: one at the center of mass, one at the diaphragm edge (which includes the effects of diaphragm rotation), and one at the span midpoint (which includes the effects of diaphragm deformation). Each location in the structure has its own Design Earthquake Displacement, and at some locations the effects of diaphragm rotation and deformation both contribute to the total displacement. In the three-dimensional view, the determination of the Design Story Drift from either the center-of-mass or diaphragm-edge Design Earthquake Displacement is illustrated. (The latter is only required for structures in Seismic Design Category C, D, E, or F with plan irregularity Type 1a or 1b.) Diaphragm deformation is not required to be considered in the determination of the Design Story Drift.

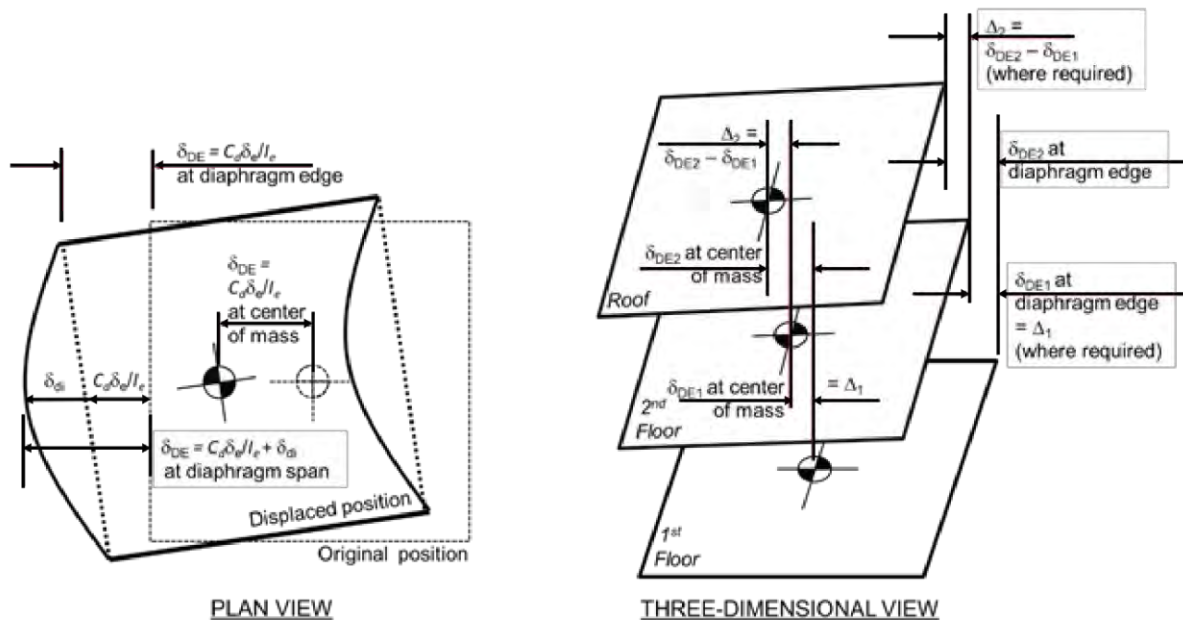

Figure C12.8-1. Design Earthquake Displacement and Design Story Drift

Where semirigid diaphragm modelling is performed and the engineer elects to compute the Design Story Drift at the center of mass without including the diaphragm deformation, the engineer may determine the theoretical displacement at the center of mass based on the displacements of the vertical elements of the seismic-force resisting system. In some cases, this can be approximated using a rigid-diaphragm analysis.

The drift corresponding to the Design Earthquake Displacement may exceed the Design Story Drift in certain cases, such as in buildings with highly flexible diaphragms. As the drift limits only apply to the Design Story Drift, the Design Earthquake drift (determined from the Design Earthquake Displacements) may therefore exceed the drift limit at those locations. Where this is the case the engineer should consider documenting the Design Earthquake Displacements if it is possible that the design of drift-sensitive building components such as cladding and certain nonstructural attachments will be done by others under the incorrect assumption that the entire structure complies with the drift limits.

Where other standards refer to the “Design Story Drift” or “design displacement” the engineer should consider whether the Design Earthquake Displacement (or the corresponding drift) is the appropriate quantity to use.

The Design Story Drifts must be less than the allowable story drifts, Δ_a , of Table 12.12-1. For structures without torsional irregularity, computations are performed using deflections of the centers of mass of the floors bounding the story. If the eccentricity between the centers of mass of two adjacent floors, or a floor and a roof, is more than 5% of the width of the diaphragm extents, it is permitted to compute the deflection for the bottom of the story at the point on the floor that is vertically aligned with the location of the center of mass of the top floor or roof. This situation can arise where a building has story offsets and the diaphragm extents of the top of the story are smaller than the extents of the bottom of the story. For structures assigned to Seismic Design Category C, D, E, or F that are torsionally irregular, the standard requires that deflections be computed along the edges of the diaphragm extents using two vertically aligned points.

Figure C12.8-6 illustrates the force-displacement relationships between elastic response, response to reduced design-level forces, and the expected inelastic response. If the structure remained elastic during an earthquake, the force developed would be V_E , and the corresponding displacement would be δ_E . V_E does not include R , which accounts primarily for ductility and system overstrength. According to the equal displacement approximation rule of seismic response, the maximum displacement of an inelastic system is approximately equal to that of an elastic system with the same initial stiffness. This condition has been observed for structures idealized with bilinear inelastic response and a fundamental period, T , greater than T_S (see Section 11.4.6). For shorter period structures, peak displacement of an inelastic system tends to exceed that of the corresponding elastic system. Because the forces are reduced by R , the resulting displacements are representative of an elastic system and need to be amplified to account for inelastic response.

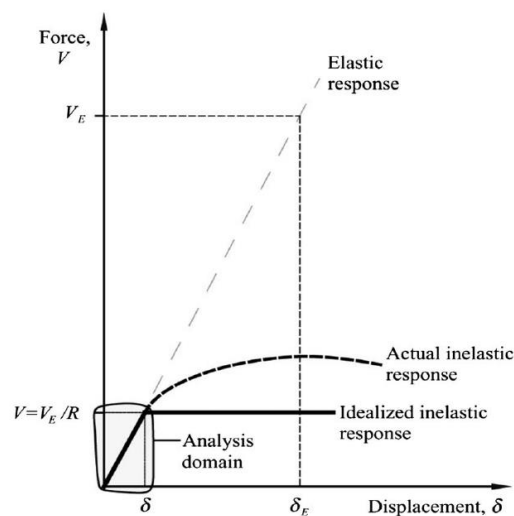

FIGURE C12.8-6 Displacements Used to Compute Drift

The deflection amplification factor, C_d , in Eq. (12.8-15) amplifies the displacements computed from an elastic analysis using prescribed forces to represent the expected inelastic displacement for the design-level earthquake and is typically less than R (Section C12.1.1). It is important to note that C_d is a story-level amplification factor and does not represent displacement amplification of the elastic response of a structure, either modeled as an *effective* single-degree-of-freedom structure (fundamental mode) or a constant amplification to represent the deflected shape of a multiple-degree-of-freedom structure, in effect, implying that the mode shapes do not change during inelastic response. Furthermore, drift-level forces are different than design-level forces used for strength compliance of the structural elements. Drift forces are typically lower because the computed fundamental period can be used to compute the base shear (see Section C12.8.6.2).

When conducting a drift analysis, the analyst should be attentive to the applied gravity loads used in combination with the strength-level earthquake forces so that consistency between the forces used in the drift analysis and those used for stability verification (P- Δ) in Section 12.8.7 is maintained, including consistency in computing the fundamental period if a second-order analysis is used. Further discussion is provided in Section C12.8.7.

The design forces used to compute the elastic deflection (δ_{xe}) include the Importance Factor, I_e , so Eq. (12.8-15) includes I_e in the denominator. This inclusion is appropriate because the allowable story drifts (except for masonry shear wall structures) in Table 12.12-1 are more stringent for higher Risk Categories.

C12.8.6.1 Minimum Base Shear for Computing Drift.

Except for period limits (as described in Section C12.8.6.2), all of the requirements of Section 12.8 must be satisfied when computing drift for an ELF analysis, except that the minimum base shear determined from applying Eq. (12.8-5) does not need to be considered. This equation represents a minimum strength that needs to be provided to a system (see Section C12.8.1.1). Eq. (12.8-6) needs to be considered, when triggered, because it represents the increase in the response spectrum in the long-period range from near-fault effects.

C12.8.6.2 Period for Computing Drift.

Where the design response spectrum of Section 11.4.6 or the corresponding equations of Section 12.8.1 are used and the fundamental period of the structure, T , is less than the long-period transition period, T_L , displacements increase with increasing period (even though forces may decrease). Section 12.8.2 applies an upper limit on T so that design forces are not underestimated, but if the lateral forces used to compute drifts are inconsistent with the forces corresponding to T , then displacements can be overestimated. To account for this variation in dynamic response, the standard allows the determination of displacements using forces that are consistent with the computed fundamental period of the structure without the upper limit of Section 12.8.2.

The analyst must still be attentive to the period used to compute drift forces. The same analytical representation (see Section C12.7.3) of the structure used for strength design must also be used for computing displacements. Similarly, the same analysis method (Table 12.6-1) used to compute design forces must also be used to compute drift forces. It is generally appropriate to use 85% of the computed fundamental period to account for mass and stiffness inaccuracies as a precaution against overly flexible structures, but it need not be taken as less than that used for strength design. The more flexible the structure, the more likely it is that P-delta effects ultimately control the design (see Section C12.8.7). Computed values of T that are significantly greater than (perhaps more than 1.5 times in high seismic areas) $C_u T_d$ may indicate a modeling error. Similar to the discussion in Section C12.8.2, the analyst should assess the value of C_u used where serviceability constraints from wind effects add significant stiffness to the structure.

C12.8.7 P-Delta Effects.

Figure C12.8-7 shows an idealized static force-displacement response for a simple one-story structure (e.g., idealized as an inverted pendulum-type structure). As the top of the structure displaces laterally, the gravity load, P , supported by the structure acts through that displacement and produces an increase in overturning moment by P times the story drift, Δ , that must be resisted by the structure—the so-called “P-delta ($P-\Delta$) effect.” This effect also influences the lateral displacement response of the structure from an applied lateral force, F .

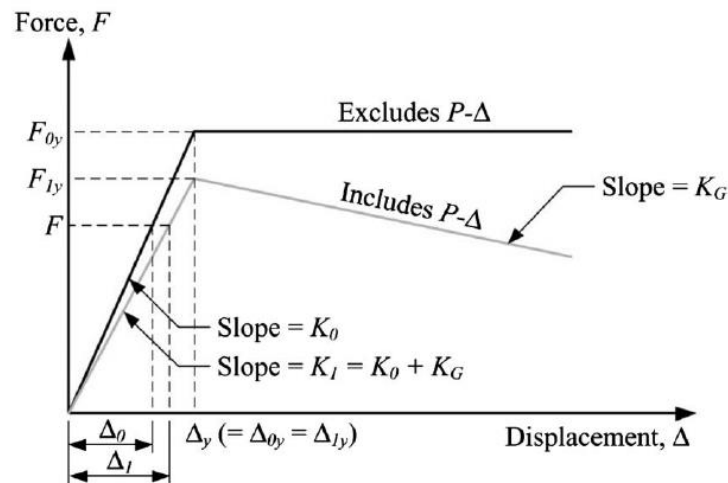

FIGURE C12.8-7 Idealized Response of a One-Story Structure with and without P-Δ

The response of the structure not considering the $P-\Delta$ effect is depicted by Condition 0 in the Figure with a slope of K_0 and lateral first-order yield force F_{0y} . This condition characterizes the first-order response of the structure (the response of the structure from an analysis not including P-delta effects). Where the $P-\Delta$ effect is included (depicted by Condition 1 in the Figure), the related quantities are K_1 and K_{1y} . This condition characterizes the second-order response of the structure (the response of the structure from an analysis including P-delta effects).

The geometric stiffness of the structure, K_G , in this example is equal to the gravity load, P , divided by the story height, h_{sx} . K_G is used to represent the change in lateral response by analytically reducing the elastic stiffness, K_0 . K_G is negative where gravity loads cause compression in the structure. Because the two response conditions in the Figure are for the same structure, the inherent yield displacement of the structure is the same ($\Delta_{0y} = \Delta_{1y} = \Delta_y$).

Two consequential points taken from the Figure are (1) the increase in required strength and stiffness of the seismic force-resisting system where the $P-\Delta$ effect influences the lateral response of the structure must be accounted for in design, and (2) the $P-\Delta$ effect can create a negative stiffness condition during postyield response, which could initiate instability of the structure. Where the postyield stiffness of the structure may become negative, dynamic displacement demands can increase significantly (Gupta and Krawinkler 2000).

One approach that can be used to assess the influence of the $P-\Delta$ effect on the lateral response of a structure is to compare the first-order response to the second-order response, which can be done using an elastic stability coefficient, θ , defined as the absolute value of K_G divided by K_0 .

$$\theta = \frac{|K_G|}{K_0} = \left| \frac{P\Delta_{0y}}{F_{0y}h_{sx}} \right| \quad (\text{C12.8-1})$$

Given the above, and the geometric relationships shown in Figure C12.8-7, it can be shown that the force producing yield in condition 1 (with $P-\Delta$ effects) is

$$F_{1y} = F_{0y}(1 - \theta) \quad (\text{C12.8-2})$$

and that for a force, F , less than or equal to F_{1y}

$$\Delta_1 = \frac{\Delta_0}{1 - \theta} \quad (\text{C12.8-3})$$

Therefore, the stiffness ratio, K_0 / K_1 , is

$$\frac{K_0}{K_1} = \frac{1}{1 - \theta} \quad (\text{C12.8-4})$$

In the previous equations,

F_{0y} = the lateral first-order yield force;

F_{1y} = the lateral second-order yield force;

h_{sx} = the story height (or structure height in this example);

K_G = the geometric stiffness;

K_0 = the elastic first-order stiffness;

K_1 = the elastic second-order stiffness;

P = the total gravity load supported by the structure;

Δ_0 = the lateral first-order drift;

Δ_{0y} = the lateral first-order yield drift;

Δ_1 = the lateral second-order drift;

Δ_{1y} = the lateral second-order yield drift; and

θ = the elastic stability coefficient.

A physical interpretation of this effect is that to achieve the second-order response depicted in the Figure, the seismic force-resisting system must be designed to have the increased stiffness and strength depicted by the first-order response. As θ approaches unity, Δ_1 approaches infinity and F_1 approaches zero, defining a state of static instability.

The intent of Section 12.8.7 is to determine whether $P-\Delta$ effects are significant when considering the first-order response of a structure and, if so, to increase the strength and stiffness of the structure to account for $P-\Delta$ effects. Some material-specific design standards require $P-\Delta$ effects to always be included in the elastic analysis of a structure and strength design of its members. The amplification of first-order member forces in accordance with Section 12.8.7 should not be misinterpreted to mean that these other requirements can be disregarded; nor should they be applied concurrently. Therefore, Section 12.8.7 is primarily used to verify compliance with the allowable drifts and check against potential postearthquake instability of the structure, while provisions in material-specific design standards are used to increase member forces for

design, if provided. In doing so, the analyst should be attentive to the stiffness of each member used in the mathematical model so that synergy between standards is maintained.

Eq. (12.8-16) is used to determine the elastic stability coefficient, θ , of each story of a structure.

$$\theta = \left| \frac{P\Delta_0}{F_0 h_{sx}} \right| = \frac{P\Delta_e}{V_x h_{sx} C_d} \quad (\text{C12.8-5})$$

Where

h_{sx} , C_d , and V_x are the same as defined in the standard and

F_0 = the force in a story causing $\Delta_0 = \sum F_x = V_x$;

Δ_0 = the elastic lateral story drift = Δ_e / C_d ;

Δ = the inelastic story drift determined in accordance with Section 12.8.6; and

P = the total *point-in-time* gravity load supported by the structure.

Structures with θ less than 0.10 generally are expected to have a positive monotonic postyield stiffness. Where θ for any story exceeds 0.10, P- Δ effects must be considered for the entire structure using one of the two approaches in the standard. Either first-order displacements and member forces are multiplied by $1/(1-\theta)$ or the P- Δ effect is explicitly included in the structural analysis and the resulting θ is multiplied by $1/(1+\theta)$ to verify compliance with the first-order stability limit. Most commercial computer programs can perform second-order analysis. The analyst must therefore be attentive to the algorithm incorporated in the software and cognizant of any limitations, including suitability of iterative and noniterative methods, inclusion of second-order effects (P- Δ and P- δ) in automated modal analyses, and appropriateness of superposition of design forces.

Gravity load drives the increase in lateral displacements from the equivalent lateral forces. The standard requires the total vertical design load, and the largest vertical design load for combination with earthquake loads is given by combination 6 from Section 2.3.6, which is transformed to

$$(1.2 + 0.2S_{DS})D + 1.0L + 0.2S + 1.0E$$

where the 1.0 factor on L is actually 0.5 for many common occupancies. The provision of Section 12.8.7 allows the factor on dead load D to be reduced to 1.0 for the purpose of P-delta analysis under seismic loads. The vertical seismic component need not be considered for checking θ_{max} .

As explained in the commentary for Chapter 2, the 0.5 and 0.2 factors on L and S , respectively, are intended to capture the arbitrary point-in-time values of those loads. The factor 1.0 results in the dead load effect being fairly close to best estimates of the arbitrary point-in-time value for dead load. L is defined in Chapter 4 of the standard to include the reduction in live load based on floor area. Many commercially available computer programs do not include live load reduction in the basic structural analysis. In such programs, live reduction is applied only in the checking of design criteria; this difference results in a conservative calculation with regard to the requirement of the standard.

The seismic story shear, V_x (in accordance with Section 12.8.4), used to compute θ includes the Importance Factor, I_e . Furthermore, the design story drift, Δ (in accordance with Section 12.8.6), does not include

this factor. Therefore, I_e has been added to Eq. (12.8-16) to correct an apparent omission in previous editions of the standard. Nevertheless, the standard has always required V_x and Δ used in this equation to be those occurring simultaneously.

Eq. (12.8-17) establishes the maximum stability coefficient, θ_{\max} , permitted. The intent of this requirement is to protect structures from the possibility of instability triggered by postearthquake residual deformation. The danger of such failures is real and may not be eliminated by apparently available overstrength. This problem is particularly true of structures designed in regions of lower seismicity.

For the idealized system shown in Figure C12.8-7, assume that the maximum displacement is $C_d \Delta_0$. Assuming that the unloading stiffness, K_u , is equal to the elastic stiffness, K_0 , the residual displacement is

$$\left(C_d - \frac{1}{\beta}\right) \Delta_0 \quad (\text{C12.8-6})$$

Additionally, assume that there is a factor of safety, FS , of 2 against instability at the maximum residual drift, $\Delta_{r,\max}$. Evaluating the overturning and resisting moments ($F_0 = V_0$ in this example),

$$P \Delta_{r,\max} \leq \frac{V_0}{\beta FS} h \quad \text{where} \quad \beta = \frac{V_0}{V_{0y}} \leq 1.0 \quad (\text{C12.8-7})$$

Therefore,

$$\frac{P[\Delta_0(\beta C_d - 1)]}{V_0 h} \leq 0.5 \rightarrow \theta_{\max}(\beta C_d - 1) = 0.5 \rightarrow \theta_{\max} = \frac{0.5}{\beta C_d - 1} \quad (\text{C12.8-8})$$

Conservatively assume that $\beta C_d - 1 \approx \beta C_d$

$$\theta_{\max} = \frac{0.5}{\beta C_d} \leq 0.25 \quad (\text{C12.8-9})$$

In the previous equations,

C_d = the displacement amplification factor;

FS = the factor of safety;

h_{sx} = the story height (or height of the structure in this example);

P = the total point-in-time gravity load supported by the structure;

V_0 = the first-order story shear demand;

V_{0y} = the first-order yield strength of the story;

β = the ratio of shear demand to shear capacity;

Δ_0 = the elastic lateral story drift;

$\Delta_{r,\max}$ = the maximum residual drift at $V_0 = 0$; and

θ_{\max} = the maximum elastic stability coefficient.

The standard requires that the computed stability coefficient, θ , not exceed 0.25 or $0.5/\beta C_d$, where βC_d is an adjusted ductility demand that takes into account the variation between the story strength demand and the story strength supplied. The story strength demand is simply V_x . The story strength supplied may be

computed as the shear in the story that occurs simultaneously with the attainment of the development of first significant yield of the overall structure. To compute first significant yield, the structure should be loaded with a seismic force pattern similar to that used to compute story strength demand and iteratively increased until first yield. Alternatively, a simple and conservative procedure is to compute the ratio of demand to strength for each member of the seismic force-resisting system in a particular story and then use the largest such ratio as β .

The principal reason for inclusion of β is to allow for a more equitable analysis of those structures in which substantial extra strength is provided, whether as a result of added stiffness for drift control, code-required wind resistance, or simply a feature of other aspects of the design. Some structures inherently possess more strength than required, but instability is not typically a concern. For many flexible structures, the proportions of the structural members are controlled by drift requirements rather than strength requirements; consequently, β is less than 1.0 because the members provided are larger and stronger than required. This method has the effect of reducing the inelastic component of total seismic drift, and thus, β is placed as a factor on C_d .

Accurate evaluation of β would require consideration of all pertinent load combinations to find the maximum ratio of demand to capacity caused by seismic load effects in each member. A conservative simplification is to divide the total demand with seismic load effects included by the total capacity; this simplification covers all load combinations in which dead and live load effects add to seismic load effects. If a member is controlled by a load combination where dead load counteracts seismic load effects, to be correctly computed, β must be based only on the seismic component, not the total. The gravity load, p , in the P- Δ computation would be less in such a circumstance and, therefore, θ would be less. The importance of the counteracting load combination does have to be considered, but it rarely controls instability.

Although the P- Δ procedure in the standard reflects a simple static idealization as shown in Figure C12.8-7, the real issue is one of dynamic stability. To adequately evaluate second-order effects during an earthquake, a nonlinear response history analysis should be performed that reflects variability of ground motions and system properties, including initial stiffness, strain hardening stiffness, initial strength, hysteretic behavior, and magnitude of point-in-time gravity load, p . Unfortunately, the dynamic response of structures is highly sensitive to such parameters, causing considerable dispersion to appear in the results (Vamvatsikos 2002). This dispersion, which increases dramatically with stability coefficient θ , is caused primarily by the incrementally increasing residual deformations (ratcheting) that occur during the response. Residual deformations may be controlled by increasing either the initial strength or the secondary stiffness. Gupta and Krawinkler (2000) give additional information.

C12.9 LINEAR DYNAMIC ANALYSIS

C12.9.1 Modal Response Spectrum Analysis.

In the modal response spectrum analysis method, the structure is decomposed into a number of single-degree-of-freedom systems, each having its own mode shape and natural period of vibration. The number of modes available is equal to the number of mass degrees of freedom of the structure, so the number of modes can be reduced by eliminating mass degrees of freedom. For example, rigid diaphragm constraints may be used to reduce the number of mass degrees of freedom to one per story for planar models and to three per story (two translations and rotation about the vertical axis) for three-dimensional structures. However, where the vertical elements of the seismic force-resisting system have significant differences in lateral stiffness, rigid diaphragm models should be used with caution because relatively small in-plane diaphragm deformations can have a significant effect on the distribution of forces.

For a given direction of loading, the displacement in each mode is determined from the corresponding spectral acceleration, modal participation, and mode shape. Because the sign (positive or negative) and the

time of occurrence of the maximum acceleration are lost in creating a response spectrum, there is no way to recombine modal responses exactly. However, statistical combination of modal responses produces reasonably accurate estimates of displacements and component forces. The loss of signs for computed quantities leads to problems in interpreting force results where seismic effects are combined with gravity effects, produce forces that are not in equilibrium, and make it impossible to plot deflected shapes of the structure.

C12.9.1.1 Number of Modes.

The key motivation to perform modal response spectrum analysis is to determine how the actual distribution of mass and stiffness of a structure affects the elastic displacements and member forces. Where at least 90% of the modal mass participates in the response, the distribution of forces and displacements is sufficient for design. The scaling required by Section 12.9.1.4 controls the overall magnitude of design values so that incomplete mass participation does not produce nonconservative results.

The number of modes required to achieve 90% modal mass participation is usually a small fraction of the total number of modes. Lopez and Cruz (1996) contribute further discussion of the number of modes to use for modal response spectrum analysis.

In general, the provisions require modal analysis to determine all individual modes of vibration, but permit modes with periods less than or equal to 0.05 s to be collectively treated as a single, rigid mode of response with an assumed period of 0.05 s. In general, structural modes of interest to building design have periods greater than 0.05 s (frequencies greater than 20 Hz), and earthquake records tend to have little, if any, energy, at frequencies greater than 20 Hz. Thus, only “rigid” response is expected for modes with frequencies above 20 Hz. Although not responding dynamically, the “residual mass” of modes with frequencies greater than 20 Hz should be included in the analysis to avoid underestimation of earthquake design forces.

Section 4.3 of ASCE 4 (ASCE 2000) provides formulas that may be used to calculate the modal properties of the residual-mass mode. When using the formulas of ASCE 4 to calculate residual-mass mode properties, the “cut-off” frequency should be taken as 20 Hz and the response spectral acceleration at 20 Hz (0.05 s) should be assumed to govern response of the residual-mass mode. It may be noted that the properties of residual-mass mode are derived from the properties of modes with frequencies less than or equal to 20 Hz, such that modal analysis need only determine properties of modes of vibration with periods greater than 0.05 s (when the residual-mass mode is included in the modal analysis). The design response spectral acceleration at 0.05 s (20 Hz) should be determined using Eq. (11.4-5) of this standard where the design response spectrum shown in Figure 11.4-1 is being used for the design analysis. Substituting 0.05 s for T and $0.2T_s$ for T_0 in Eq. (11.4-5), one obtains the residual-mode response spectral acceleration as $S_a = S_{Ds} [0.4 + 0.15/T_s]$. Most general-purpose linear structural analysis software has the capacity to consider residual mass modes in order to meet the existing requirements ASCE 4 (ASCE 2000).

The exception permits excluding modes of vibration when such would result in a modal mass in each orthogonal direction of at least 90% of the actual mass. This approach has been included in ASCE 7 (2003, 2010) for many years and is still considered adequate for most building structures that typically do not have significant modal mass in the very short period range.

C12.9.1.2 Modal Response Parameters.

The design response spectrum (whether the general spectrum from Section 11.4.6 or a site-specific spectrum determined in accordance with Section 21.2) is representative of linear elastic structures. Division of the spectral ordinates by the response modification coefficient, R , accounts for inelastic behavior, and multiplication of spectral ordinates by the Importance Factor, I_e , provides the additional strength needed to improve the performance of important structures. The displacements that are computed using the response

spectrum that has been modified by R and I_e (for strength) must be amplified by C_d and reduced by I_e to produce the expected inelastic displacements (see Section C12.8.6.)

C12.9.1.3 Combined Response Parameters.

Most computer programs provide for either the SRSS or the CQC method (Wilson et al. 1981) of modal combination. The two methods are identical where applied to planar structures, or where zero damping is specified for the computation of the cross-modal coefficients in the CQC method. The modal damping specified in each mode for the CQC method should be equal to the damping level that was used in the development of the design response spectrum. For the spectrum in Section 11.4.6, the damping ratio is 0.05.

The SRSS or CQC method is applied to loading in one direction at a time. Where Section 12.5 requires explicit consideration of orthogonal loading effects, the results from one direction of loading may be added to 30% of the results from loading in an orthogonal direction. Wilson (2000) suggests that a more accurate approach is to use the SRSS method to combine 100% of the results from each of two orthogonal directions where the individual directional results have been combined by SRSS or CQC, as appropriate.

The CQC4 method, as modified by ASCE 4 (1998), is specified and is an alternative to the required use of the CQC method where there are closely spaced modes with significant cross-correlation of translational and torsional response. The CQC4 method varies slightly from the CQC method through the use of a parameter that forces a correlation in modal responses where they are partially or completely in phase with the input motion. This difference primarily affects structures with short fundamental periods, T , that have significant components of response that are in phase with the ground motion. In these cases, using the CQC method can be nonconservative. A general overview of the various modal response combination methods can be found in U.S Nuclear Regulatory Commission (2012).

The SRSS or CQC method is applied to loading in one direction at a time. Where Section 12.5 requires explicit consideration of orthogonal loading effects, the results from one direction of loading may be added to 30% of the results from loading in an orthogonal direction. Wilson (2000) suggests that a more accurate approach is to use the SRSS method to combine 100% of the results from each of two orthogonal directions where the individual directional results have been combined by SRSS or CQC, as appropriate. Menun and Der Kiureghian (1998) propose an alternate method, referred to as CQC3, which provides the critical orientation of the earthquake relative to the structure. Wilson (2000) now endorses the CQC3 method for combining the results from multiple component analyses.

C12.9.1.4 Scaling Design Values of Combined Response.

The modal base shear, V_i , may be less than the ELF base shear, V , because: (a) the calculated fundamental period, T , may be longer than that used in computing V , (b) the response is not characterized by a single mode, or (c) the ELF base shear assumes 100% mass participation in the first mode, which is always an overestimate.

C12.9.1.4.1 Scaling of Forces.

The scaling required by Section 12.9.1.4.1 provides, in effect, a minimum base shear for design. This minimum base shear is provided because the computed fundamental period may be the result of an overly flexible (incorrect) analytical model. Recent studies of building collapse performance, such as those of FEMA P-695 (the ATC-63 project, 2009b), NIST GCR 10-917-8 (the ATC-76 project) and NIST GCR 12-917-20 (the ATC-84 project) show that designs based on the ELF procedure generally result in better collapse performance than those based on modal response spectrum analysis (MRSA) with the 15% reduction in base shear included. In addition, many of the designs using scaled MRSA did not achieve the targeted 10% probability of collapse given MCE ground shaking. Whereas scaling to 100% of the ELF base shear and to 100% of the drifts associated with Eq. (12.8-6) does not necessarily achieve the intended collapse performance, it does result in performance that is closer to the stated goals of this standard.

C12.9.1.4.2 Scaling of Drifts.

Displacements from the modal response spectrum are only scaled to the ELF base shear where V_i is less than $C_s W$ and C_s is determined based on Eq. (12.8-6). For all other situations, the displacements need not be scaled because the use of an overly flexible model will result in conservative estimates of displacement that need not be further scaled. The reason for requiring scaling when Eq. (12.8-6) controls the minimum base shear is to be consistent with the requirements for designs based on the ELF procedure.

C12.9.1.5 Horizontal Shear Distribution.

Torsion effects in accordance with Section 12.8.4 must be included in the modal response spectrum analysis (MRSA) as specified in Section 12.9 by requiring use of the procedures in Section 12.8 for the determination of the seismic base shear, V . There are two basic approaches for consideration of accidental torsion.

The first approach follows the static procedure discussed in Section C12.8.4.2, where the total seismic lateral forces obtained from MRSA—using the computed locations of the centers of mass and rigidity—are statically applied at an artificial point offset from the center of mass to compute the accidental torsional moments. Most computer programs can automate this procedure for three-dimensional analysis. Alternatively, the torsional moments can be statically applied as separate load cases and added to the results obtained from MRSA.

Because this approach is a static approximation, amplification of the accidental torsion in accordance with Section 12.8.4.3 is required. MRSA results in a single, positive response, thus inhibiting direct assessment of torsional response. One method to circumvent this problem is to determine the maximum and average displacements for each mode participating in the direction being considered and then apply modal combination rules (primarily the CQC method) to obtain the total displacements used to check torsional irregularity and compute the amplification factor, A_x . The analyst should be attentive about how accidental torsion is included for individual modal responses.

The second approach, which applies primarily to three-dimensional analysis, is to modify the dynamic characteristics of the structure so that dynamic amplification of the accidental torsion is directly considered. This modification can be done, for example, by either reassigning the lumped mass for each floor and roof (rigid diaphragm) to alternate points offset from the initially calculated center of mass and modifying the mass moment of inertia, or physically relocating the initially calculated center of mass on each floor and roof by modifying the horizontal mass distribution (typically presumed to be uniformly distributed). This approach increases the computational demand significantly because all possible configurations would have to be analyzed, primarily two additional analyses for each principal axis of the structure. The advantage of this approach is that the dynamic effects of direct loading and accidental torsion are assessed automatically. Practical disadvantages are the increased bookkeeping required to track multiple analyses and the cumbersome calculations of the mass properties.

Where this “dynamic” approach is used, amplification of the accidental torsion in accordance with Section 12.8.4.3 is not required because repositioning the center of mass increases the coupling between the torsional and lateral modal responses, directly capturing the amplification of the accidental torsion.

Most computer programs that include accidental torsion in a MRSA do so statically (first approach discussed above) and do not physically shift the center of mass. The designer should be aware of the methodology used for consideration of accidental torsion in the selected computer program.

C12.9.1.6 P-Delta Effects.

The requirements of Section 12.8.7, including the stability coefficient limit, θ_{\max} , apply to modal response spectrum analysis.

C12.9.1.7 Soil–Structure Interaction Reduction.

The standard permits including soil–structure interaction (SSI) effects in a modal response spectrum analysis in accordance with Chapter 19. The increased use of modal analysis for design stems from computer analysis programs automatically performing such an analysis. However, common commercial programs do not give analysts the ability to customize modal response parameters. This problem hinders the ability to include SSI effects in an automated modal analysis.

C12.9.1.8 Structural Modeling.

Using modern software, it often is more difficult to decompose a structure into planar models than it is to develop a full three-dimensional model. As a result, three-dimensional models are now commonplace. Increased computational efficiency also allows efficient modeling of diaphragm flexibility. As a result, when modal response spectrum analysis is used, a three-dimensional model is required for all structures, including those with diaphragms that can be designated as flexible.

C12.9.2 Linear Response History Analysis**C12.9.2.1 General Requirements.**

The linear response history (LRH) analysis method provided in this section is intended as an alternate to the modal response spectrum (MRS) analysis method. The principal motivation for providing the LRH analysis method is that signs (positive–negative bending moments, tension–compression brace forces) are preserved, whereas they are lost in forming the SRSS and CQC combination in MRS analysis.

It is important to note that, like the ELF procedure and the MRS analysis method, the LRH analysis method is used as a basis for structural design, and not to predict how the structure will respond to a given ground motion. Thus, in the method provided in this section, spectrum-matched ground motions are used in lieu of amplitude-scaled motions. The analysis may be performed using modal superposition, or by analysis of the fully coupled equations of motion (often referred to as direct integration response history analysis).

As discussed in Section 12.9.2.3, the LRH analysis method requires the use of three sets of ground motions, with two orthogonal components in each set. These motions are then modified such that the response spectra of the modified motions closely match the shape of the target response spectrum. Thus, the maximum computed response in each mode is virtually identical to the value obtained from the target response spectrum. The only difference between the MRS analysis method and the LRH analysis method (as developed in this section using the spectrum-matched ground motions) is that in the MRS analysis method the system response is computed by statistical combination (SRSS or CQC) of the modal responses and in the LRH analysis method, the system response is obtained by direct addition of modal responses or by simultaneous solution of the full set of equations of motion.

C12.9.2.2 General Modeling Requirements.

Three-dimensional (3D) modeling is required for conformance with the inherent and accidental torsion requirements of Section 12.9.2.2.2.

C12.9.2.2.1 P-Delta Effects.

A static analysis is required to determine the stability coefficients using Eq. (12.8-17). Typically, the mathematical model used to compute the quantity Δ in Eq. (12.8-16) does not directly include P-delta

effects. However, Section 12.8.7 provides a methodology for checking compliance with the θ_{\max} limit where P-delta effects are directly included in the model. For dynamic analysis, an ex post facto modification of results from an analysis that does not include P-delta effects to one that does (approximately) include such effects is not rational.

Given that virtually all software that performs linear response history analysis has the capability to directly include P-delta effects, it is required that P-delta effects be included in all analyses, even when the maximum stability ratio at any level is less than 0.1. The inclusion of such effects causes a lengthening of the period of vibration of the structure, and this period should be used for establishing the range of periods for spectrum matching (Section 12.9.2.3.1) and for selecting the number of modes to include in the response (Section 12.9.2.2.4).

While the P-delta effect is essentially a nonlinear phenomenon (stiffness depends on displacements and displacements depend on stiffness), such effects are often “linearized” by forming a constant geometric stiffness matrix that is created from member forces generated from an initial gravity load analysis (Wilson and Habibullah 1987; Wilson 2004). This approach works for both the modal superposition method and the direct analysis method. It is noted, however, that there are some approximations in this method, principally the way the global torsional component of P-delta effects is handled. The method is of sufficient accuracy in analysis for which materials remain elastic. Where direct integration is used, a more accurate response can be computed by iteratively updating the geometric stiffness at each time step or by iteratively satisfying equilibrium about the deformed configuration. In either case, the analysis is in fact “nonlinear,” but it is considered as a linear analysis in Section 12.9.2 because material properties remain linear.

For 3D models, it is important to use a realistic spatial distribution of gravity loads because such a distribution is necessary to capture torsional P-delta effects.

C12.9.2.2.2 Accidental Torsion.

The required 5% offset of the center of mass need not be applied in both orthogonal directions at the same time. Direct modeling of accidental torsion by offsetting the center of mass is required to retain the signs (positive–negative bending moments, tension–compression forces in braces). In addition to the four mathematical models with mass offsets, a fifth model without accidental torsion (including only inherent torsion) must also be prepared. The model without accidental torsion is needed as the basis for scaling results as required in Section 12.9.2.5. Though not a requirement of the LRH analysis method, the analyst may also compare the modal characteristics (periods, mode shapes) to the systems with and without accidental mass eccentricity to gauge the sensitivity of the structure to accidental torsional response.

C12.9.2.2.3 Foundation Modeling.

Foundation flexibility may be included in the analysis. Where such modeling is used, the requirements of Section 12.13.3 should be satisfied. Additional guidance on modeling foundation effects may be found in *Nonlinear Structural Analysis for Seismic Design: A Guide for Practicing Engineers* (NIST 2010).

C12.9.2.2.4 Number of Modes to Include in Modal Response History Analysis.

Where modal response history analysis is used, it is common to analyze only a subset of the modes. In the past, the number of modes to analyze has been determined such that a minimum of 90% of the effective mass in each direction is captured in the response. An alternate procedure that produces participation of 100% of the effective mass is to represent all modes with periods less than 0.05 s in a single rigid body mode having a period of 0.05 s. In direct analysis, the question of the number of modes to include does not arise because the system response is computed without modal decomposition.

An example of a situation where it would be difficult to obtain 90% of the mass in a reasonable number of modes is reported in Chapter 4 of FEMA P-751 (2013), which presents the dynamic analysis of a 12-story building over a 1-story basement. When the basement walls and grade-level diaphragm were excluded from

the model, 12 modes were sufficient to capture 90% of the effective mass. When the basement was modeled as a stiff first story, it took more than 120 modes to capture 90% of the total mass (including the basement and the ground-level diaphragm). It is noted in the Chapter 4 discussion that when the full structure was modeled and only 12 modes were used, the member forces and system deformations obtained were virtually identical to those obtained when 12 modes were used for the fixed-base system (modeled without the podium).

If modal response history analysis is used and it is desired to use a mathematical model that includes a stiff podium, it might be beneficial to use Ritz vectors in lieu of eigenvectors (Wilson 2004). Another approach is the use of the “static correction method,” in which the responses of the higher modes are determined by a static analysis instead of a dynamic analysis (Chopra 2007). The requirement in Section 12.9.2.2.4 of including all modes with periods of less than 0.05 s as a rigid body mode is in fact an implementation of the static correction method.

C12.9.2.2.5 Damping.

Where modal superposition analysis is used, 5% damping should be specified for each mode because it is equal to the damping used in the development of the response spectrum specified in Section 11.4.6 and in Section 21.1.3. Where direct analysis is used, it is possible but not common to form a damping matrix that provides uniform damping across all modes (Wilson and Penzien 1972). It is more common to use a mass and stiffness proportional damping matrix (i.e., Rayleigh damping), but when this is done, the damping ratio may be specified at only two periods. Damping ratios at other periods depend on the mass and stiffness proportionality constants. At periods associated with higher modes, the damping ratios may become excessive, effectively damping out important modes of response. To control this effect, Section 12.9.2.2.5 requires the damping in all included modes (with periods as low as T_{lower}) be less than or equal to 5% critical.

C12.9.2.3 Ground Motion Selection and Modification.

Response spectrum matching (also called spectral matching) is the nonuniform scaling of an actual or artificial ground motion such that its pseudoacceleration response spectrum closely matches a target spectrum. In most cases, the target spectrum is the same spectrum used for scaling actual recorded ground motions (i.e., the ASCE 7 design spectrum). Spectral matching can be contrasted with amplitude scaling, in which a uniform scale factor is applied to the ground motion. The principal advantage of spectral matching is that fewer ground motions, compared to amplitude scaling, can be used to arrive at an acceptable estimate of the mean response as recommended in NIST GCR 11-918-15 (NIST 2011). Figure C12.9-1(a) shows the response spectra of two ground motions that have been spectral matched, and Figure C12.9-1(b) shows the response spectra of the original ground motions. In both cases, the ground motions are normalized to match the target response spectrum at a period of 1.10 s. Clearly, the two amplitude-scaled records will result in significantly different responses, whereas analysis using the spectrum-matched records will be similar. As described later, however, there is enough variation in the response using spectrum-matched records to require the use of more than one record in the response history analysis.

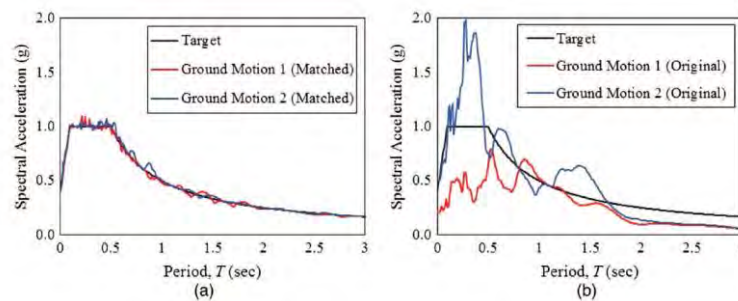

FIGURE C12.9-1. Spectral Matching vs. Amplitude-Scaled Response Spectra

A variety of methods is available for spectrum matching, and the reader is referred to Hancock et al. (2006) for details. Additional information on use of spectrum-matched ground motions in response history analysis is provided by Grant and Diaferia (2012).

C12.9.2.3.1 Procedure for Spectrum Matching.

Experience with spectrum matching has indicated that it is easier to get a good match when the matching period extends beyond the period range of interest. It is for this reason that spectrum matching is required over the range $0.8T_{\text{lower}}$ to $1.2T_{\text{upper}}$. For the purposes of this section, a good match is defined when the ordinates of the average (arithmetic mean) of the computed acceleration spectrum from the matched records in each direction does not fall above or below the target spectrum by more than 10% over the period range of interest.

C12.9.2.4 Application of Ground Acceleration Histories.

One of the advantages of linear response history analysis is that analyses for gravity loads and for ground shaking may be computed separately and then combined in accordance with Section 12.4.2. Where linear response history analysis is performed in accordance with Section 12.9.2, it is required that each direction of response for each ground motion be computed independently. This requirement is based on the need to apply different scaling factors in the two orthogonal directions. Analyses with and without accidental torsion are required to be run for each ground motion. Thus, the total number of response histories that need to be computed is 18. (For each ground motion, one analysis is needed in each direction without mass eccentricity, and two analyses are needed in each direction to account for accidental torsion. These six cases times three ground motions give 18 required analyses.)

C12.9.2.5 Modification of Response for Design.

The dynamic responses computed using spectrum-matched motions are elastic responses and must be modified for inelastic behavior.

For force-based quantities, the design base shear computed from the dynamic analysis must not be less than the base shear computed using the equivalent lateral force procedure. The factors η_x and η_y , computed in Section 12.9.2.5.2, serve that purpose. Next, the force responses must be multiplied by I_e and divided by R . This modification, together with the application of the ELF scale factors, is accomplished in Section 12.9.2.5.3.

For displacement base quantities, it is not required to normalize to ELF, and computed response history quantities need be multiplied only by the appropriate C_d/R in the direction of interest. This step is accomplished in Section 12.9.2.5.4.

Whereas accidental torsion is not required for determining the maximum elastic base shear, which is used only for determining the required base shear scaling, it is required for all analyses that are used to determine design displacements and member forces.

C12.9.2.6 Enveloping of Force Response Quantities.

Forces used in design are the envelope of forces computed from all analyses. Thus, for a brace, the maximum tension and the maximum compression forces are obtained. For a beam-column, envelope values of axial force and envelope values of bending moment are obtained, but these actions do not likely occur at the same time, and using these values in checking member capacity is not rational. The preferred approach is to record the histories of axial forces and bending moments, and to plot their traces together with the interaction diagram of the member. If all points of the force trace fall inside the interaction diagram, for all

ground motions analyzed, the design is sufficient. An alternate is to record member demand to capacity ratio histories (also called usage ratio histories), and to base the design check on the envelope of these values.

C12.10 DIAPHRAGMS, CHORDS, AND COLLECTORS

This section permits a choice of diaphragm design in accordance with the provisions in Sections 12.10.1 and 12.10.2, Section 12.10.3, or the new provisions of Section 12.10.4. The diaphragm seismic design provisions in Sections 12.10.1 and 12.10.2 are the basic design method. Section 12.10.3 is an alternative method, first included in the 2015 *NEHRP Provisions* and ASCE 7-16. In Section 12.10.4, another alternative design method is provided. The Section 12.10.4 alternative method is permitted only for one-story structures employing flexible diaphragms with rigid vertical elements. For a given diaphragm, one of these three methods should be selected and implemented. Where a group of diaphragms is similar enough in elevation that they would be anticipated to interact, the use of one diaphragm design method for the group of diaphragms is recommended.

Section 12.10.3 provides diaphragm seismic design provisions that specifically recognize and account for the effect of diaphragm ductility and displacement capacity on the diaphragm design forces. This is accomplished with the introduction of a *diaphragm design force reduction factor*, R_s . Neither the number of stories, nor the building configuration is restricted by the Section 12.10.3 provisions, however diaphragm construction is limited to the diaphragm systems specifically noted within those provisions.

Section 12.10.3 is mandatory for precast concrete diaphragms in structures assigned to SDC C, D, E and F, and is optional for precast concrete diaphragms in SDC B and cast-in-place concrete, wood, and bare steel deck diaphragms in structures assigned to all SDCs. The required mandatory use of Section 12.10.3 for precast diaphragm systems in SDC C through F is based on recent research that indicates that improved earthquake performance can thus be attained. Many conventional diaphragm systems designed in accordance with Section 12.10.1 and 12.10.2 have performed adequately. Continued use of Sections 12.10.1 and 12.10.2 is considered reasonable for diaphragm systems other than those for which Section 12.10.3 is mandated.

Section 12.10.4 introduces diaphragm seismic design provisions that are permitted to be used for one-story structures combining flexible diaphragms with rigid vertical elements. The seismic design methodology specifically recognizes the dynamic response of these structures as being dominated by dynamic response of and inelastic behavior in the diaphragm. While the most common occurrences of this structure type are the concrete tilt-up and masonry “big-box” structures, the *rigid vertical element* terminology of this section recognizes a wider range of vertical elements for which this methodology is permitted to be used. This approach is based on numerical studies conducted as part of the development of the 2015 guideline document *Seismic Design of Rigid Wall-Flexible Diaphragm Buildings: An Alternate Procedure* (FEMA P-1026), supplemented by additional recent steel deck diaphragm research. These studies indicate that improved seismic performance can be obtained for this group of structures through use of this design methodology. The primary use of Section 12.10.4 provisions is intended to be for structures where one or more spans of the diaphragm exceeds 100 feet; however use for structures in which all diaphragm spans are less than 100 feet is not precluded.

C12.10.1 Diaphragm Design.

Diaphragms are generally treated as horizontal deep beams or trusses that distribute lateral forces to the vertical elements of the seismic force-resisting system. As deep beams, diaphragms must be designed to resist the resultant shear and bending stresses. Diaphragms are commonly compared to girders, with the roof or floor deck analogous to the girder web in resisting shear, and the boundary elements (chords) analogous to the flanges of the girder in resisting flexural tension and compression. As in girder design, the

chord members (flanges) must be sufficiently connected to the body of the diaphragm (web) to prevent separation and to force the diaphragm to work as a single unit.

Diaphragms may be considered flexible, semirigid, or rigid. The flexibility or rigidity of the diaphragm determines how lateral forces are distributed to the vertical elements of the seismic force-resisting system (see Section C12.3.1). Once the distribution of lateral forces is determined, shear and moment diagrams are used to compute the diaphragm shear and chord forces. Where diaphragms are not flexible, inherent and accidental torsion must be considered in accordance with Section 12.8.4.

Diaphragm openings may require additional localized reinforcement (subchords and collectors) to resist the subdiaphragm chord forces above and below the opening and to collect shear forces where the diaphragm depth is reduced (Figure C12.10-1). Collectors on each side of the opening drag shear into the subdiaphragms above and below the opening. The subchord and collector reinforcement must extend far enough into the adjacent diaphragm to develop the axial force through shear transfer. The required development length is determined by dividing the axial force in the subchord by the shear capacity (in force/unit length) of the main diaphragm.

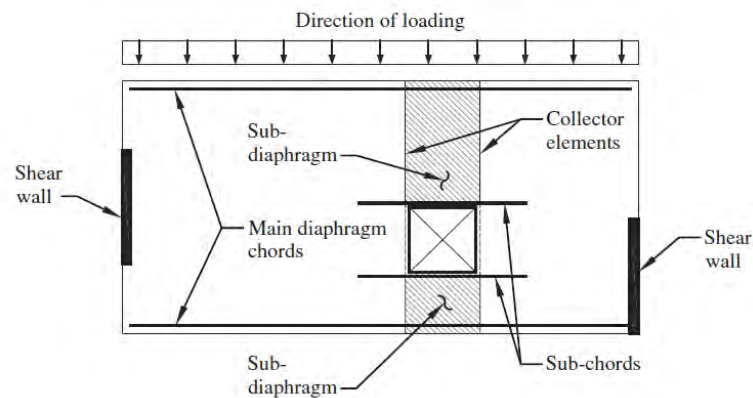

FIGURE C12.10-1 Diaphragm with an Opening

Chord reinforcement at reentrant corners must extend far enough into the main diaphragm to develop the chord force through shear transfer (Figure C12.10-2). Continuity of the chord members also must be considered where the depth of the diaphragm is not constant.

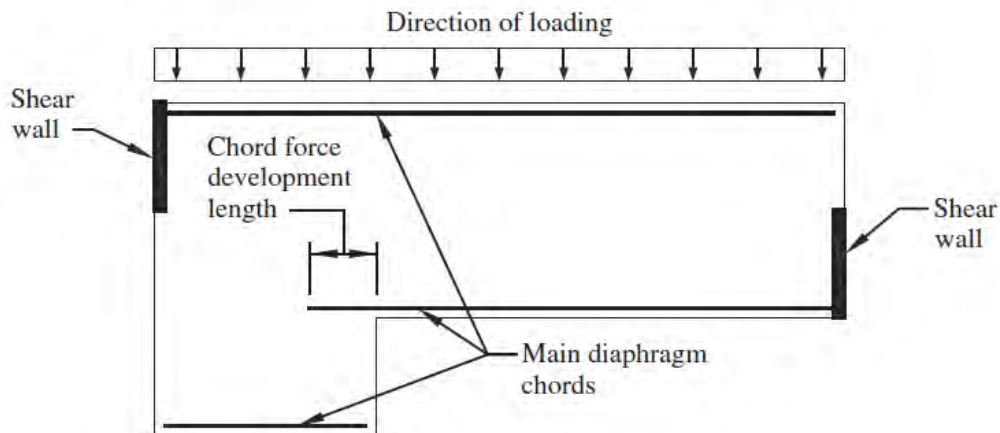

FIGURE C12.10-2 Diaphragm with a Reentrant Corner

In wood and metal deck diaphragm design, framing members are often used as continuity elements, serving as subchords and collector elements at discontinuities. These continuity members also are often used to transfer wall out-of-plane forces to the main diaphragm, where the diaphragm itself does not have the capacity to resist the anchorage force directly. For additional discussion, see Sections C12.11.2.2.3 and C12.11.2.2.4.

C12.10.1.1 Diaphragm Design Forces.

Diaphragms must be designed to resist inertial forces, as specified in Eq. (12.10-1), and to transfer design seismic forces caused by horizontal offsets or changes in stiffness of the vertical resisting elements. Inertial forces are those seismic forces that originate at the specified diaphragm level, whereas the transfer forces originate above the specified diaphragm level. The redundancy factor, ρ , used for design of the seismic force-resisting elements also applies to diaphragm transfer forces, thus completing the load path.

C12.10.2.1 Collector Elements Requiring Load Combinations Including Overstrength for Seismic Design Categories C through F.

The overstrength requirement of this section is intended to keep inelastic behavior in the ductile elements of the seismic force-resisting system (consistent with the response modification coefficient, R) rather than in collector elements.

C12.10.3 Alternative Design Provisions for Diaphragms, Including Chords and Collectors.

The provisions of Section 12.10.3 are being mandated for precast concrete diaphragms in buildings assigned to SDC C, D, E, or F and are being offered as an alternative to those of Sections 12.10.1 and 12.10.2 for other precast concrete diaphragms, cast-in-place concrete diaphragms, and wood-sheathed diaphragms supported by wood framing. Diaphragms designed by Sections 12.10.1 and 12.10.2 have generally performed adequately in past earthquakes. The level of diaphragm design force from Sections 12.10.1 and 12.10.2 may not ensure, however, that diaphragms have sufficient strength and ductility to mobilize the inelastic behavior of vertical elements of the seismic force-resisting system. Analytical and experimental results show that actual diaphragm forces over much of the height of a structure during the design-level earthquake may be significantly greater than those from Sections 12.10.1 and 12.10.2, particularly when diaphragm response is near-elastic. There are material-specific factors that are related to overstrength and deformation capacity that may account for the adequate diaphragm performance in past earthquakes. The provisions of Section 12.10.3 consider both the significantly greater forces observed in near-elastic diaphragms and the anticipated overstrength and deformation capacity of diaphragms, resulting in an improved distribution of diaphragm strength over the height of buildings and among buildings with different types of seismic force-resisting systems.

Based on experimental and analytical data and observations of building performance in past earthquakes, changes are warranted to the procedures of Sections 12.10.1 and 12.10.2 for some types of diaphragms and for some locations within structures. Examples include the large diaphragms in some parking garages.

Section 12.10.3, Item 1, footnote b to Table 12.2-1 permits reduction in the value of Ω_0 for structures with flexible diaphragms. The lowered Ω_0 results in lower diaphragm forces, which is not consistent with experimental and analytical observations. Justification for footnote b is not apparent; therefore, to avoid the inconsistency, the reduction is eliminated when using the Section 12.10.3 design provisions.

Section 12.10.3, item 2: The ASCE 7-10 Section 12.3.3.4 provision requiring a 25% increase in design forces for certain diaphragm elements in buildings with several listed irregularities is eliminated when using the Section 12.10.3 design provisions because the diaphragm design force level in this section is based on realistic assessment of anticipated diaphragm behavior. Under the Sections 12.10.1 and 12.10.2 design

provisions, the 25% increase is invariably superseded by the requirement to amplify seismic design forces for certain diaphragm elements by Ω_0 ; the only exception is wood diaphragms, which are exempt from the Ω_0 multiplier.

Section 12.10.3, items 3 and 4: Section 12.10.3.2 provides realistic seismic design forces for diaphragms. Section 12.10.3.4 requires that diaphragm collectors be designed for 1.5 times the force level used for diaphragm in-plane shear and flexure. Based on these forces, the use of a ρ factor greater than one for collector design is not necessary and would overly penalize designs. The unit value of the redundancy factor is retained for diaphragms designed by the force level given in Sections 12.10.1 and 12.10.2. This value is reflected in the deletion of item 7 and the addition of diaphragms to item 5. For transfer diaphragms, see Section 12.10.3.3.

C12.10.3.1 Design.

This provision is a rewrite of ASCE 7-10, Sections 12.10.1 and 12.10.2. The phrase “diaphragms including chords, collectors, and their connections to the vertical elements” is used consistently throughout the added or modified provisions, to emphasize that its provisions apply to all portions of a diaphragm. It is also emphasized that the diaphragm is to be designed for motions in two orthogonal directions.

C12.10.3.2 Seismic Design Forces for Diaphragms, Including Chords and Collectors.

Eq. (12.10-4) makes the diaphragm seismic design force equal to the weight tributary to the diaphragm, w_{px} , times a diaphragm design acceleration coefficient, C_{px} , divided by a diaphragm design force reduction factor, R_s , which is material-dependent and whose background is given in Section C12.10.3.5. The background to the diaphragm design acceleration coefficient, C_{px} , is given below.

The diaphragm design acceleration coefficient at any height of the building can be determined from linear interpolation, as indicated in Figure 12.10-2.

The diaphragm design acceleration coefficient at the building base, C_{p0} , equals the peak ground acceleration consistent with the design response spectrum in ASCE 7-10, Section 11.4.5, times the Importance Factor I_e . Note that the term $0.4S_{D5}$ can be calculated from Eq. (11.4-5) by making $T = 0$.

The diaphragm design acceleration coefficient at 80% of the structural height, C_{pi} , given by Eqs. (12.10-8) and (12.10-9), reflects the observation that at about this height, floor accelerations are largely, but not solely, contributed by the first mode of response. In an attempt to provide a simple design equation, coefficient C_{pi} was formulated as a function of the design base shear coefficient, C_s , of ASCE 7-10, which may be determined from equivalent static analysis or modal response spectrum analysis of the structure. Note that C_s includes a reduction by the response modification factor, R , of the seismic force-resisting system. It is magnified back up by the overstrength factor, Ω_0 , of the seismic force-resisting system because overstrength will generate higher first-mode forces in the diaphragm. In many lateral systems, at 80% of the building height, the contribution of the second mode is negligible during linear response, and during nonlinear response it is typically small, though nonnegligible. In recognition of this observation, the diaphragm seismic design coefficient at this height has been made a function of the first mode of response only, and the contribution of this mode has been factored by $0.9\Gamma_{m1}$ as a weighed value between contributions at the first-mode effective height (approximately two-thirds of the building height) and the building height.

Systems that make use of high β -factors, such as buckling, restrained braced frames (BRBFs) and moment-resisting frames (MRFs), show that in the lower floors the higher modes add to the accelerations, whereas the contribution of the first mode is minimal. For this reason, the coefficient C_{pi} needs to have a lower bound. A limit of C_{p0} has been chosen; it makes the lower floor acceleration coefficients independent of R . Wall systems are unlikely to be affected by this lower limit on C_{pi} .

At the structural height, h_n , the diaphragm design acceleration coefficient, C_{pn} , given by Eq. (12.10-7), reflects the influence of the first mode, amplified by system overstrength, and of the higher modes without amplification on the floor acceleration at this height. The individual terms are combined using the square root of the sum of the squares. The overstrength amplification of the first mode recognizes that the occurrence of an inelastic mechanism in the first mode is an anticipated event under the design earthquake, whereas inelastic mechanisms caused by higher mode behavior are not anticipated. The higher mode seismic response coefficient, C_{s2} , is computed as the smallest of the values given by Eqs. (12.10-10), (12.10-11), and (12.10-12a) or (12.10-12b). These four equations consider that the periods of the higher modes contributing to the floor acceleration can lie on the ascending, constant, or first descending branch of the design response spectrum shown in ASCE 7-10, Figure 11.4-1. Users are warned against extracting higher modes from their modal analysis of buildings and using them in lieu of the procedure presented in Section 12.10.3.2.1 because the higher mode contribution to floor accelerations can come from a number of modes, particularly when there is lateral-torsional coupling of the modes.

Note that Eq. (12.10-7) makes use of the modal contribution factor defined here as the mode shape ordinate at the building height times the modal participation factor and is uniquely defined for each mode of response (Chopra 1995). A building database was compiled to obtain approximate equations for the first mode and higher mode contribution factors. The first and second translational modes, as understood in the context of two-dimensional modal analysis, were extracted from the mode shapes obtained from three-dimensional modal analysis by considering modal ordinates at the center of mass. These buildings had diverse lateral systems, and the number of stories ranged from 3 to 23. Eqs. (12.10-13) and (12.10-14) were empirically calibrated from simple two-dimensional models of realistic frame-type and wall-type buildings and then compared with data extracted from the database (Figure C12.10-3). In Eq. (12.10-7), C_{pn} is required to be no less than C_{pi} , based on judgment, in order to eliminate instances where the design acceleration at roof level might be lower than that at $0.8h_n$. This cap will particularly affect low- z_s systems such as BRBFs.

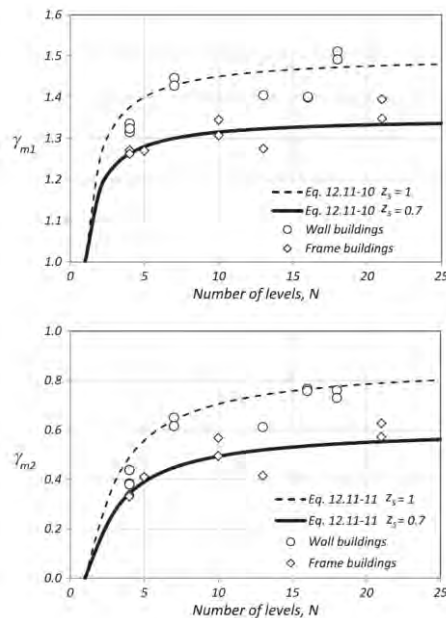

FIGURE C12.10-3 Comparison of Factors Γ_{m1} and Γ_{m2} Obtained from Analytical Models and Actual Structures with Those Predicted by Eqs. (12.10-13) and (12.10-14)

To validate Eq. (12.10-4), coefficients C_{px} were calculated for various buildings tested on a shake table. Figs. C12.10-4 and C12.10-5 plot the floor acceleration envelopes and the floor accelerations predicted from Eq. (12.10-4) with $R_s = 1$ for two buildings built at full scale and tested on a shake table (Panagiotou et al. 2011, Chen et al. 2015), with C_{p0} defined as the diaphragm design acceleration coefficient at the structure base and C_{px} defined as the diaphragm design acceleration coefficient at level x . Measured floor accelerations are reasonably predicted by Eq. (12.10-4). Research work by Choi et al. (2008) concluded that buckling-restrained braced frames are very effective in limiting floor accelerations in buildings arising from higher mode effects. This finding is reflected in this proposal, where the mode shape factor Z_s has been made the smallest for buckling-restrained braced frame systems. Figure C12.10-6 compares average floor accelerations obtained from the nonlinear time history analyses of four buildings (two steel buckling-restrained braced frame systems and two steel special moment frame systems) when subjected to an ensemble of spectrum-compatible earthquakes with floor accelerations computed from Eqs. (12.10-4) and (12.10-5). The proposed design equations predict the accelerations in the uppermost part of the building and in the lowest levels reasonably well.

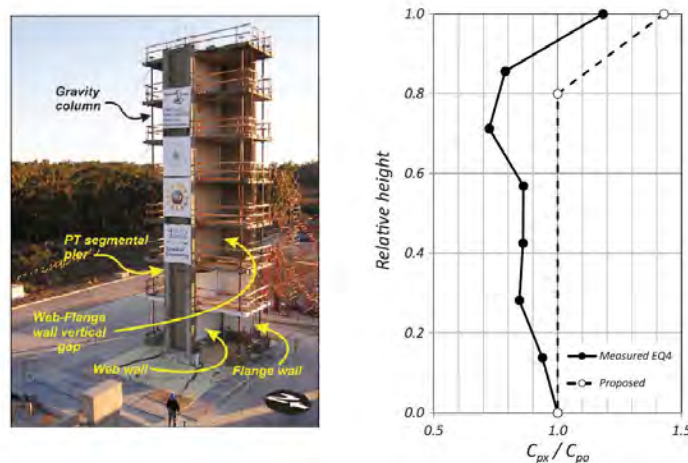

FIGURE C12.10-4 Comparison of Measured Floor Accelerations and Accelerations Predicted by Eq. (12.10-4) for a Seven-Story Bearing Wall Building

Source: Panagiotou et al. 2011.

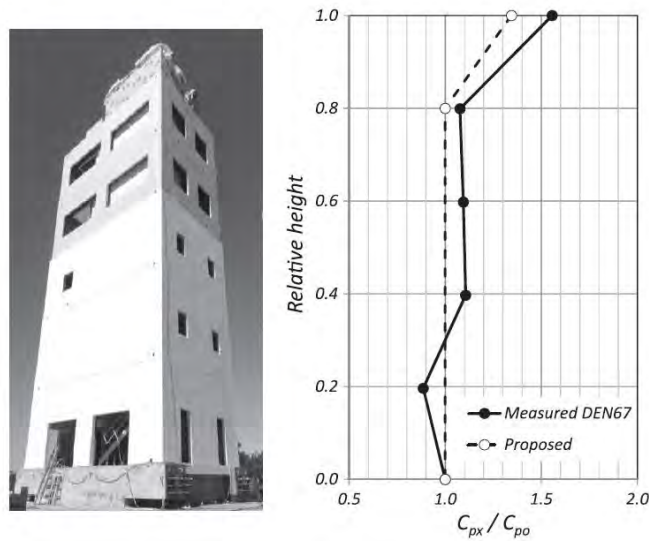

FIGURE C12.10-5 Comparison of Measured Floor Accelerations and Accelerations Predicted by Eq. (12.10-4) for a Five-Story Special Moment-Resisting Frame Building

Source: (left) Courtesy of Michelle Chen; (right) Adapted from Chen et al. (2015).

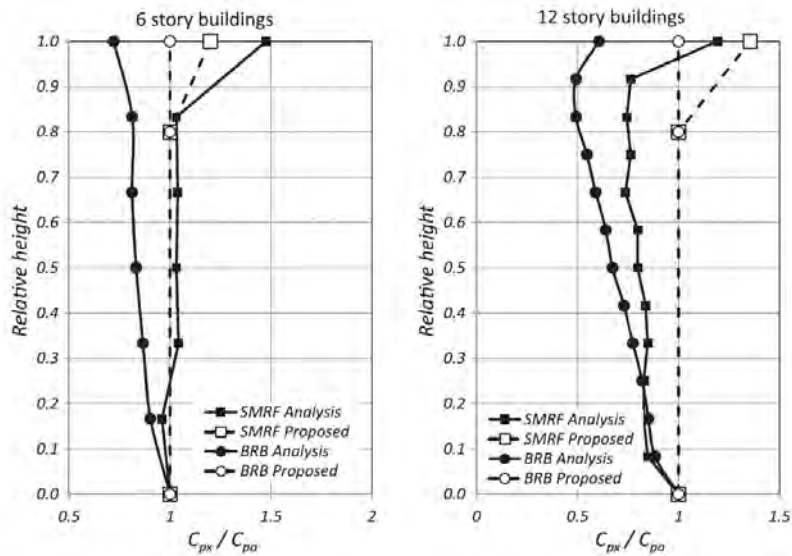

FIGURE C12.10-6 Comparison of Measured Floor Accelerations with Proposed Eqs. (12.10-4) and (12.10-5) for Steel Buckling-Restrained Braced Frame and Special Moment-Resisting Frame Buildings

Source: Adapted from Choi et al. 2008

The significant difference between a low- z_s system such as the BRBF and a high- z_s system such as a bearing wall system is that inelastic deformations are distributed throughout the height of the structure in a low- z_s system, whereas they are concentrated at the base of the structure in a high- z_s system. If rational analysis can be performed to demonstrate that inelastic deformations are in fact distributed along the height

of the structure, as is often the case with eccentrically braced frame or coupled shear wall systems, then the use of a low z_s value, as has been assigned to the BRBF for such a system, would be justified.

During the calibration of the design procedure leading to Eq. (12.10-4), it was found that at intermediate levels in lateral systems designed using large response modification coefficients, diaphragm design forces given by this equation could be rather low. There was consensus within the BSSC PUC Issue Team that developed Section 12.10.3 that diaphragm design forces should not be taken as less than the minimum force currently prescribed by ASCE 7-10, and hence they developed Eq. (12.10-5).

The procedure presented in Section 12.10.3 is based on consideration of buildings and structures whose mass distribution is reasonably uniform along the building height. Buildings or structures with tapered mass distribution along their height or with setbacks in their upper levels may experience diaphragm forces in the upper levels that are greater than those derived from Eq. (12.10-4). In such buildings and structures, it is preferable to define an effective building height, h_{ne} , and a corresponding level, n_e , the level to which the structural effective height is measured. The effective number of levels in a building, n_e , is defined as level x where the ratio $\sum_{i=1}^x w_i / \sum_{i=1}^{n_e} w_i$ first exceeds 0.95. Level 1 is defined as the first level above the base. The effective structural height, h_{ne} , is the height of the building measured from the base to level n_e . In buildings with tapered mass distribution or setbacks, the diaphragm design acceleration coefficient, C_{px} , is calculated by interpolation and extrapolation, as shown in Figure C12.10-7, with n replaced by n_e in Eqs. (12.10-10) through (12.10-14).

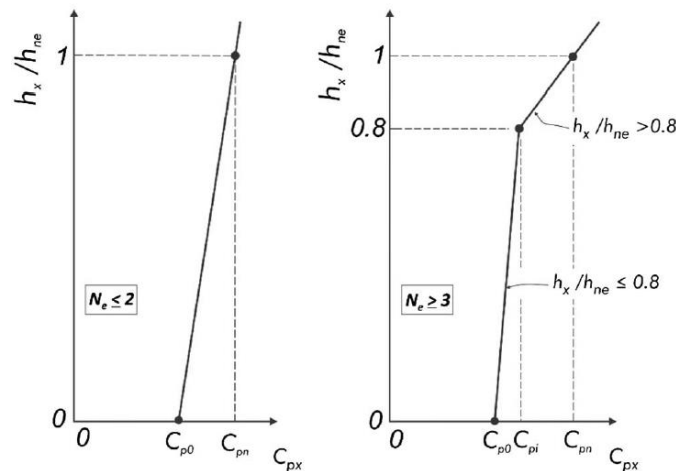

FIGURE C12.10-7 Diaphragm Design Acceleration Coefficient C_{px} for Buildings with Nonuniform Mass Distribution

C12.10.3.3 Transfer Forces in Diaphragms.

All diaphragms are subject to inertial forces caused by the weight tributary to the diaphragm. Where the relative lateral stiffnesses of vertical seismic force-resisting elements vary from story to story, or the vertical seismic force-resisting elements have out-of-plane offsets, lateral forces in the vertical elements need to be transferred through the diaphragms as part of the load path between vertical elements above and below the diaphragm. These transfer forces are in addition to the inertial forces and can at times be quite large.

For structures that have a horizontal structural irregularity of Type 4 in Table 12.3-1, the magnitude of the transfer forces is largely dependent upon the overstrength in the offset vertical elements of the seismic force-resisting system. Therefore, the transfer force caused by the offset is required to be amplified by the overstrength factor, Ω_0 , of the seismic force-resisting system. The amplified transfer force is to be added to the inertial force for the design of this portion of the diaphragm.

Transfer forces can develop in many other diaphragms, even within regular buildings; the design of diaphragms with such transfer forces can be for the sum of the transfer forces, unamplified, and the inertial forces.

C12.10.3.4 Collectors—Seismic Design Categories C through F.

For structures in Seismic Design Categories C through F, ASCE 7-10, Section 12.10.2.1 specifies the use of forces including the overstrength factor, Ω_0 , for design of diaphragm collectors and their connections to vertical elements of the seismic force-resisting system. The intent of this requirement is to increase collector forces in order to help ensure that collectors will not be the weak links in the seismic force-resisting system.

In this section the collector force is instead differentiated by using a multiplier of 1.5. This is a smaller multiplier than has been used in the past, but it is justified because the diaphragm forces are more accurately determined by Eq. (12.10-4). For collector elements of diaphragms that carry transfer forces caused by out-of-plane offsets of the vertical elements of the seismic force-resisting system, only the inertia force is amplified by 1.5; the transfer forces, already amplified by Ω_0 , are not further amplified by 1.5.

Some seismic force-resisting systems, such as braced frames and moment frames, have a fairly well defined lateral strength corresponding to a well-defined yield mechanism. When collectors deliver seismic forces to such systems, it is not sensible to have to design the collectors for forces higher than those corresponding to the lateral strength of the supporting elements in the story below. This is why the cap on collector design forces is included. The lateral strength of a braced frame or moment frame may be calculated using the same methods as are used for determining whether a weak-story irregularity is present (Table 12.3-2). It should be noted that only the moment frames or braced frames below the collector are to be considered in calculating the upper-bound collector design force. The shear strength of the gravity columns and the lateral strength of the frames above are not included.

The design forces in diaphragms that deliver forces to collectors can also be limited by the maximum forces that can be generated in those collectors by the moment frames or braced frames below.

C12.10.3.5 Diaphragm Design Force Reduction Factor.

Despite the fact that analytical and shake table studies indicate higher diaphragm accelerations than currently used in diaphragm design, many commonly used diaphragm systems, including diaphragms designed under a number of U.S. building codes and editions, have a history of excellent earthquake performance. With limited exceptions, diaphragms have not been reported to have performed below the life-safety intent of building code seismic design provisions in past earthquakes. Based on this history, it is felt that, for many diaphragm systems, no broad revision is required to the balance between demand and capacity used for design of diaphragms under current ASCE 7 provisions. In view of this observation, it was recognized that the analytical studies and diaphragm testing from which the higher accelerations and design forces were being estimated used diaphragms that were elastic or near-elastic in their response. Commonly used diaphragm systems are recognized to have a wide range of overstrength and inelastic displacement capacity (ductility). It was recognized that the effect of the varying diaphragm systems on seismic demand required evaluation and incorporation into the proposed diaphragm design forces. Eq. (12.10-4) incorporates the diaphragm overstrength and inelastic displacement capacity through the use of the diaphragm force reduction factor, R_s . This factor is most directly based on the global ductility capacity

of the diaphragm system; however, the derivation of the global ductility capacity inherently also captures the effect of diaphragm overstrength.

For diaphragm systems with inelastic deformation capacity sufficient to permit inelastic response under the design earthquake, the diaphragm design force reduction factor, R_S , is typically greater than 1.0, so that the design force demand, F_{px} , is reduced relative to the force demand for a diaphragm that remains linear elastic under the design earthquake. For diaphragm systems that do not have sufficient inelastic deformation capacity, R_S should be less than 1.0, or even 0.7, so that linear-elastic force-deformation response can be expected under the risk-targeted maximum considered earthquake (MCE_R).

Diaphragms with R_S values greater than 1.0 shall have the following characteristics: (1) a well-defined, specified yield mechanism, (2) global ductility capacity for the specified yield mechanism, which exceeds anticipated ductility demand for the risk-targeted maximum considered earthquake, and (3) sufficient local ductility capacity to provide for the intended global ductility capacity, considering that the specified yield mechanism may require concentrated local inelastic deformations to occur. The following discussion addresses these characteristics and the development of R_S -factors in detail.

A diaphragm system with an R_S value greater than 1.0 should have a specified, well-defined yield mechanism, for which both the global strength and the global deformation capacity can be estimated. For some diaphragm systems, a shear-yield mechanism may be appropriate, whereas for other diaphragm systems, a flexural-yield mechanism may be appropriate.

Figure C12.10-8(a) shows schematically the force-deformation ($F_{dia} - \Delta_{dia}$) response of a diaphragm with significant inelastic deformation capacity. The Figure illustrates the response of a diaphragm system, such as a wood diaphragm or a steel deck diaphragm, which is not expected to exhibit a distinct yield point, so that an effective yield point (F_{Y-eff} and Δ_{Y-eff}) needs to be defined. For wood diaphragms and steel deck diaphragms, the Figure illustrates one way to define the effective yield point. The stiffness of a test specimen is defined by the secant stiffness through a point corresponding to 40% of the peak strength (F_{peak}). The effective yield point (F_{Y-eff} and Δ_{Y-eff}) for a diaphragm is defined by the secant stiffness through $0.4F_{peak}$ and the nominal diaphragm strength reduced by a strength reduction factor (ϕF_n), as shown in the Figure. The $F_{dia} - \Delta_{dia}$ response is then idealized with a bilinear model, using the effective yield point (F_{Y-eff} and Δ_{Y-eff}) and F_{peak} and the corresponding deformation Δ_{peak} as shown in the Figure.

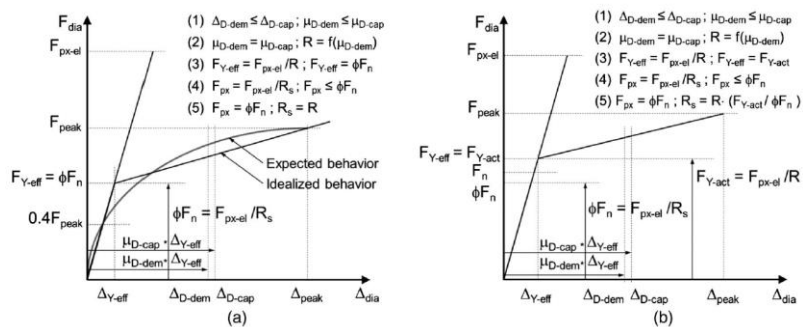

FIGURE C12.10-8. Diaphragm Inelastic Response Models for (a) a Diaphragm System That Is Not Expected to Exhibit a Distinct Yield Point and (b) a Diaphragm System That Does Exhibit a Distinct Yield Point

Figure C12.10-8(b) shows schematically the force-deformation ($F_{\text{dia}} - \Delta_{\text{dia}}$) response of a diaphragm with significant inelastic deformation capacity, which is expected to have nearly linear $F_{\text{dia}} - \Delta_{\text{dia}}$ response up to a distinct yield point, such as a cast-in-place reinforced concrete diaphragm. For this type of diaphragm system, the effective yield point can be taken as the actual yield point ($F_{Y\text{-actual}}$ and $\Delta_{Y\text{-actual}}$) of the diaphragm (accounting for diaphragm material overstrength and not including a strength reduction factor (ϕ)).

The global (or system) deformation capacity of a diaphragm system (Δ_{cap}) should be estimated from analyses of test data. The force-deformation ($F_{\text{dia}} - \Delta_{\text{dia}}$) response shown schematically in Figs. C12.10-8(a) and C12.10-8(b) is the global force-deformation behavior.

In some cases, tests provide directly the global deformation capacity, but more often, tests provide only the local response, including the strength and deformation capacity, of diaphragm components and connections. When tests provide only the local deformation capacity, analyses of typical diaphragms should be made to estimate the global deformation capacity of these diaphragms. These analyses should consider: (1) the specified yield mechanism, (2) the local force-deformation response data from tests, (3) the typical distributions of design strength and internal force demands across the diaphragm, and (4) any other factors that may require concentrated local inelastic deformation to occur when the intended yield mechanism forms.

After the global force-deformation ($F_{\text{dia}} - \Delta_{\text{dia}}$) response of a diaphragm has been estimated, the global deformation capacity (Δ_{cap}) can be determined. In Figure C12.10-8(a), for example, Δ_{cap} can be taken as Δ_{peak} , which is the deformation corresponding to the strength (F_{peak}). For some diaphragm systems, it may be acceptable to take the deformation corresponding to 80% of F_{peak} (i.e., postpeak) as Δ_{cap} .

Only a selected portion of the deformation capacity of a diaphragm (Δ_{cap}) should be used under the design earthquake in recognition of two major concerns: (1) the diaphragm must perform adequately under the MCE_R, which has a design spectrum 50% more intense than the design earthquake design spectrum, and (2) significant inelastic deformation under the design earthquake may result in undesirable damage to the diaphragm. As a rough estimate, the diaphragm deformation capacity under the design earthquake ($\Delta_{D\text{-cap}}$) should be limited to approximately one-half to two-thirds of the deformation capacity Δ_{cap} .

To develop the diaphragm force reduction factor, R_s , the diaphragm global deformation capacity should be expressed as a global ductility capacity (μ_{cap}), which equals the deformation capacity (Δ_{cap}) divided by the effective yield deformation ($\Delta_{Y\text{-eff}}$). The corresponding diaphragm design ductility capacity ($\mu_{D\text{-cap}}$) equals $\Delta_{D\text{-cap}} / \Delta_{Y\text{-eff}}$.

From the diaphragm global deformation capacity and corresponding ductility capacity, an appropriate R_s factor can be estimated. Use of the estimated R_s factor in design should result in diaphragm ductility demands that do not exceed the ductility capacity that was used to estimate R_s . The force reduction factor is ideally derived from system-specific studies. Where such studies are unavailable, however, some guidance on the conversion from global ductility to force reduction is available from past studies.

Expressions that provide the force reduction factor, R , for the seismic force-resisting system of a building corresponding to an expected ductility demand (μ_{dem}) have been proposed by numerous research teams. Numerous factors, including vibration period, inherent damping, deformation hardening (stiffness after the

effective yield point), and hysteretic energy dissipation under cyclic loading, have been considered in developing these expressions. Two such expressions, which are based on elastoplastic force-deformation response under cyclic loading (Newmark and Hall 1982), are as follows: (1) $R = (2\mu_{\text{dem}} - 1)^{0.5}$, applicable to short-period systems, and (2) $R = \mu_{\text{dem}}$, applicable to systems with longer periods. The first function, known as the equal energy rule, gives a smaller value of R for a given value of μ_{dem} ; the second function, known as the equal displacement rule, is also widely used.

Figs. C12.10-8(a) and C12.10-8(b) summarize an approach to estimating R_s as follows:

1. For the selected value of R_s , the diaphragm deformation demand under the design earthquake ($\Delta_{D\text{-dem}}$) should not exceed the diaphragm design deformation capacity ($\Delta_{D\text{-cap}}$). This design constraint, expressed in terms of diaphragm ductility, requires that the diaphragm ductility demand under the design earthquake ($\mu_{D\text{-dem}}$) should not exceed the diaphragm design ductility capacity ($\mu_{D\text{-cap}}$).
2. The largest value of R that can be justified for a given diaphragm design deformation capacity is obtained by setting the ductility demand ($\mu_{D\text{-dem}}$) equal to the design ductility capacity ($\mu_{D\text{-cap}}$) and determining R from a function that provides R for a given μ_{dem} . For example, if $\mu_{D\text{-cap}} = 2.5$, then $\mu_{D\text{-dem}}$ is set equal to 2.5 and the corresponding $R = 2$ from the equal energy rule or $R = 2.5$ from the equal displacement rule.
3. R_s from step (2) is the ratio of the force demand for a linear elastic diaphragm ($F_{px\text{-el}}$) to the effective yield strength of the diaphragm ($F_{Y\text{-eff}}$). For a diaphragm system that is not expected to exhibit a distinct yield point (Figure C12.10-8a), $F_{Y\text{-eff}}$ equals the factored nominal diaphragm strength (ϕF_n). For a diaphragm system that is expected to exhibit a distinct yield point (Figure C12.10-8b), $F_{Y\text{-eff}}$ equals the actual yield strength ($F_{Y\text{-actual}}$), accounting for diaphragm material overstrength and not including the strength reduction factor (ϕ).
4. R_s is, however, defined as the ratio of the force demand for a linear elastic diaphragm ($F_{px\text{-el}}$) to the design force demand (F_{px}). The diaphragm must be designed such that the design force demand (F_{px}) is less than or equal to the factored nominal diaphragm strength (ϕF_n).
5. For a diaphragm system without a distinct yield point (Figure C12.10-8(a)) that has the minimum strength ($F_{px} = \phi F_n$), R_s equals R from step (2). For a diaphragm system with a distinct yield point (Figure C12.10-8(b)), which has the minimum strength ($F_{px} = \phi F_n$), R_s equals R from step (2) multiplied by the ratio $F_{Y\text{-eff}} / \phi F_n$.

Diaphragm force reduction factors, R_s , have been developed for some commonly used diaphragm systems. The derivation of factors for each of these systems is explained in detail in the following commentary sections. For each, the specific design standard considered in the development of the R_s factor is specified. The resulting R_s factors are specifically tied to the design and detailing requirements of the noted standard because these play a significant role in setting the ductility and overstrength of the diaphragm system. For this reason, the applicability of the R_s factor to diaphragms designed using other standards must be specifically considered and justified.

Cast-in-Place Concrete Diaphragms. The R_s values in Table 12.10-1 address cast-in-place concrete diaphragms designed in accordance with ACI 318.

Intended Mechanism. Flexural yielding is the intended yield mechanism for a reinforced concrete diaphragm. Where this can be achieved, designation as a flexure-controlled diaphragm and use of the corresponding R_s factor in Table 12.10-1 is appropriate. There are many circumstances, however, where the development of a well-defined yielding mechanism is not possible because of diaphragm geometry (aspect ratio or complex diaphragm configuration), in which case, designation as a shear-controlled diaphragm and use of the lower R_s factor is required.

Derivation of Diaphragm Force Reduction Factor. Test results for reinforced concrete diaphragms are not available in the literature. Test results for shear walls under cyclic lateral loading were considered. The critical regions of shear wall test specimens usually have high levels of shear force, moment, and flexural deformation demands; high levels of shear force are known to degrade the flexural ductility capacity. The flexural ductility capacity of shear wall test specimens under cyclic lateral loading was used to estimate the flexural ductility capacity of reinforced concrete diaphragms, using the previously described method based on Newmark and Hall (1982).

Based on shear wall test results, the estimated global flexural ductility capacity of a reinforced concrete diaphragm is 3, based on the actual yield displacement ($\Delta_{Y\text{-actual}}$) of the test specimens. The design ductility capacity is taken as two-thirds of the ductility capacity; the design ductility capacity ($\mu_{D\text{-cap}}$) is 2.

Setting the ductility demand (μ_{dem}) equal to the design ductility capacity ($\mu_{D\text{-cap}}$) and using the equal energy rule, the force reduction factor R is $R = (2\mu_{\text{dem}} - 1)^{0.5} = 1.73$.

R_s equals R multiplied by the ratio $F_{Y\text{-eff}} / \phi F_n$. $F_{Y\text{-eff}}$ is taken equal to $F_{Y\text{-actual}}$, which is assumed to be $1.1F_n$ and ϕ equals 0.9. Therefore, $R_s = 2.11$, which is rounded to 2.

Because of the geometric characteristics of a building or other factors, such as minimum reinforcement requirements, it is not possible to design some reinforced concrete diaphragms to yield in flexure. Such diaphragms are termed “shear controlled” to indicate that they are expected to yield in shear. Shear-controlled reinforced concrete diaphragms should be designed to remain essentially elastic under the design earthquake, with their available global ductility held in reserve for safety under the MCE_R .

Based on the following considerations, R_s is specified as 1.5 for shear-controlled reinforced concrete diaphragms: Reinforced-concrete diaphragms have performed well in past earthquakes. ACI-318 specifies ϕ of 0.75 or 0.6 for diaphragm shear strength and limits the concrete contribution to the shear strength to only $2(f'_c)^{0.5}$. In addition, reinforced concrete floor slabs often have gravity load reinforcement that is not considered in determining the diaphragm shear strength. Therefore, shear-controlled reinforced concrete diaphragms are expected to have significant overstrength. The ratio $F_{Y\text{-eff}} / \phi F_n$ for a reinforced concrete diaphragm, where $F_{Y\text{-eff}}$ is taken equal to $F_{Y\text{-actual}}$, is expected to exceed 1.5, which is the rationale for $R_s = 1.5$, even though μ_{dem} is assumed to be 1 for the design earthquake.

Precast Concrete Diaphragms. The R_s values in Table 12.10-1 address precast concrete diaphragms designed in accordance with ACI 318.

Derivation of Diaphragm Force Reduction Factors. The diaphragm force reduction factors, R_s , in Table 12.10-1 for precast concrete diaphragms were established based on the results of analytical earthquake simulation studies conducted within a multiple-university project: Diaphragm Seismic Design

Methodology (DSDM) for Precast Concrete Diaphragms (Fleischman et al. 2013). In this research effort, diaphragm design force levels have been aligned with the diaphragm deformation capacities specifically for precast concrete diaphragms. Three different design options were proposed according to different design performance targets, as indicated in Table C12.10-1. The relationships between diaphragm design force levels and diaphragm local/global ductility demands have been established in the DSDM research project. These relationships have been used to derive the R_s for precast concrete diaphragms in Table 12.10-1.

Table C12.10-1. Diaphragm Design Performance Targets

	Flexure		Shear
Options	DE	MCE _R	DE and MCE _R
EDO	Elastic	Elastic	Elastic
BDO	Elastic	Inelastic	Elastic
RDO	Inelastic	Inelastic	Elastic

Note: DE, design earthquake, MCE_R, risk-targeted maximum considered earthquake, EDO, elastic design objective; BDO, basic design objective; and RDO, reduced design objective.

Diaphragm R_{dia} - μ_{global} - μ_{local} Relationships. Extensive analytical studies have been performed (Fleischman et al. 2013) to develop the relationship of R_{dia} - μ_{global} - μ_{local} . R_{dia} is the diaphragm force reduction factor (similar to the R_s in Table 12.10-1) measured from the required elastic diaphragm design force at MCE_R level. μ_{global} is the diaphragm global ductility demand, and μ_{local} is the diaphragm local connector ductility demand measured at MCE level. Figure C12.10-9 shows the μ_{global} - μ_{local} and R_{dia} - μ_{global} analytical results for different diaphragm aspect ratios (AR) and proposed linear equations derived from the data.

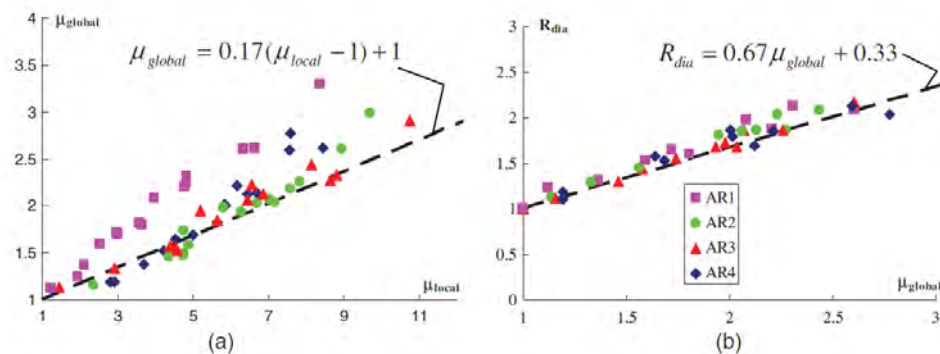

FIGURE C12.10-9. Relationships: (a) μ_{global} - μ_{local} and (b) R_{dia} - μ_{global}

Diaphragm Force Reduction Factor (R_s). Using the equations in Figure C12.10-9, the R_s can be calculated for different diaphragm design options provided that the diaphragm local reinforcement ductility

capacity is known. In the DSDM research, precast diaphragm connectors have been extensively tested (Fleischman et al. 2013) and have been qualified into three categories: high deformability elements (HDEs), moderate deformability elements (MDEs), and low deformability elements (LDEs), which are required as a minimum for designs using the reduced design objective (RDO), the basic design objective (BDO), and the elastic design objective (EDO), respectively. The local deformation and ductility capacities for diaphragm connector categories are shown in Table C12.10-2. Considering that the proposed diaphragm design force level [Eq. (12.10-1)] targets elastic diaphragm response at the design earthquake, which is equivalent to design using BDO where $\mu_{\text{local}} = 3.5$ at MCE_R (see Table C12.10-2), the available diaphragm global ductility capacity has to be reduced from Figure C12.10-9(a), acknowledging more severe demands in the MCE_R ,

$$\mu_{\text{global,red}} = 0.17(\mu_{\text{local}} - 3.5) + 1 \quad (\text{C12.10-1})$$

Table C12.10-2 Diaphragm Force Reduction Factors,

Options	Diaphragm Connector Category	δ_{local} (in.)	μ_{local}	μ_{global}	$\mu_{\text{global, red}}$	R_s
EDO	LDE	0.06	1.0	1.0	0.58	0.7
BDO	MDE	0.2	3.5	1.4	1.0	1.0
RDO	HDE	0.4	7.0	2.0	1.6	1.4

Note: EDO, elastic design objective; LDE, low deformability elements; BDO, basic design objective; MDE, moderate deformability elements; RDO reduced design objective, and HDE, high deformability elements.

Accordingly, the R_s -factor can be modified from Figure C12.10-9(b) (see Table C12.10-2):

$$R_s = 0.67\mu_{\text{global,red}} + 0.33 \quad (\text{C12.10-2})$$

Diaphragm Shear Overstrength Factor. Precast diaphragms typically exhibit ductile flexural response but brittle shear response. In order to avoid brittle shear failure, elastic shear response targets are required for both flexure-controlled and shear-controlled systems at design earthquake and MCE_R levels. Thus, a shear overstrength factor, Ω_v , is required for diaphragm shear design. For EDO design, since the diaphragm is expected to remain elastic under the MCE_R , no shear overstrength is needed. Figure C12.10-10 shows the analytical results for required shear overstrength factors for BDO and RDO (shown as marks). A simplified conservative equation is proposed as (see black lines in Figure C12.10-10):

$$\Omega_v = 1.4R_s \quad (\text{C12.10-3})$$

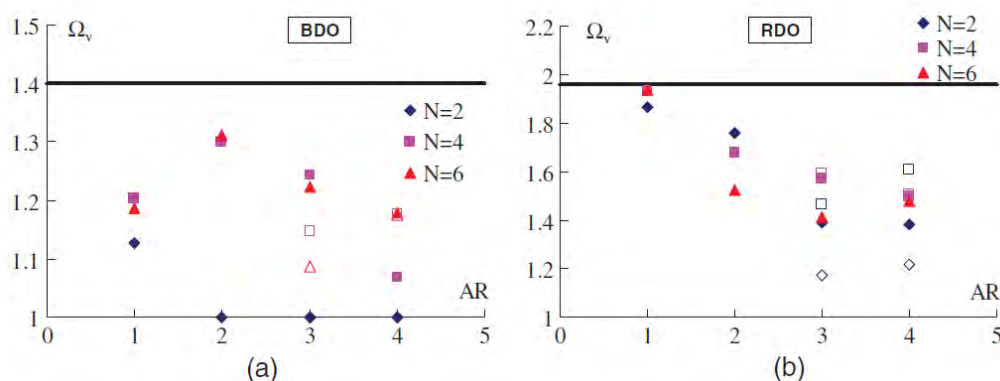

FIGURE C12.10-10 Diaphragm Shear Overstrength Factor, Ω_v , vs. Aspect Ratio, AR, for Different Numbers of Stories, N : (a) BDO; (b) RDO

Source: Fleischman et al. 2013.

Wood-Sheathed Diaphragms. The R_s values given in Table 12.10-1 are for wood-sheathed diaphragms designed in accordance with *Special Design Provisions for Wind and Seismic* (AWC 2008).

Intended Mechanism. Wood-sheathed diaphragms are shear-controlled, with design strength determined in accordance with AWC (2008) and the shear behavior based on the sheathing-to-framing connections. Wood diaphragm chord members are unlikely to form flexural mechanisms (ductile or otherwise) because of the overstrength inherent in axially loaded members designed in accordance with applicable standards.

Derivation of Diaphragm Design Force Reduction Factor. An R_s factor of 3 is assigned in Table 12.10-1, based on diaphragm test data (APA 1966, 2000, DFPA 1954, 1963) and analytical studies. The available testing includes diaphragm spans (loaded as simple-span beams) ranging from 24 to 48 ft (7.3 to 14.6 m), aspect ratios ranging between 1 and 3.3, and diaphragm construction covering a range of construction types including blocked and unblocked construction, and regular and high-load diaphragms. The loading was applied with a series of point loads at varying spacing; however, the loading was reasonably close to uniform. Whereas available diaphragm testing was monotonic, based on shear wall loading protocol studies (Gatto and Uang 2002), it is believed that the monotonic load-deflection behavior is reasonably representative of the cyclic load-deflection envelope, suggesting that it is appropriate to use monotonic load-deflection behavior in the estimation of overstrength, ductility, and displacement capacity.

Analytical studies using nonlinear response history analysis evaluated the relationship between global ductility and diaphragm force reduction factor for a model wood building. The analysis identified the resulting diaphragm force reduction factor as ranging from just below 3 to significantly in excess of 5. A force reduction factor of 3 was selected so that diaphragm design force levels would generally not be less than determined in accordance with provisions of Section 12.10.

The calibration approach for selection of R_s of 3 was considered appropriate to limit conditions where diaphragm force levels would drop below those determined in accordance with Section 12.10. This was due in part to historical experience of good diaphragm performance across a range of wood diaphragm types, even though test data showed varying levels of ductility and deformation capacity. Tests of nailed wood diaphragms showed significant but varying levels of overstrength. It is recognized that even further variation of overstrength will result from

- Presence of floor coverings or toppings and their attachment or bond to diaphragm sheathing,

- Presence of wall to floor framing nailing through diaphragm sheathing, and
- Presence of adhesives in combination with required sheathing nailing (commonly used for purposes of mitigating floor vibration, increasing floor stiffness for gravity loading, and reducing the potential for squeaking).

These sources of overstrength are not considered to be detrimental to overall diaphragm performance.

Bare Steel Deck Diaphragms. The R_s values in Table 12.10-1 address bare (untopped) steel deck diaphragms designed in accordance with AISI S400. These include diaphragms meeting requirements for special seismic detailing, and all other bare steel deck diaphragms.

Intended Mechanism. The ductility of bare steel deck diaphragms is largely driven by the performance of the deck profile and its interaction with sidelap and structural connections. It has been found for a specific class of WR roof deck that if the sidelap and structural connections have adequate ductility and deformation capacity, the full bare steel deck diaphragm can similarly develop productive levels of ductility with sufficient system-level deformation capacity (O'Brien et al 2017, Schafer 2019). These findings formed the basis for prescriptive special seismic detailing requirements that are found in AISI S400 as referenced from Section 14.1.5. AISI S400 also provides performance-based criteria to establish that selected detailing associated with a particular bare steel deck diaphragm (new profile, new connector, etc.) meets the same performance objectives as the prescriptive system – and is thus is deemed to provide an intended ductile mechanism. Other bare steel deck diaphragms have fasteners and system behavior that is less ductile. As a result, the R_s factor is smaller, resulting in design for near-elastic level forces.

Derivation of Diaphragm Force Reduction Factor. The derivation of the bare steel deck diaphragm force reduction factor, R_s , is summarized in Appendix 1 of Schafer (2019). The ductility and deformation capacity of sidelap and structural connections employed in bare steel deck diaphragms is established by evaluation of new cyclic shear testing (NBM 2017, 2018, Schafer 2019). The ductility of bare steel deck diaphragms is preliminarily established by assembly and evaluation of existing cyclic cantilever diaphragm tests (O'Brien et al. 2017). The impact of the connector and cantilever diaphragm tests on full building performance is assessed in a 3D building model as detailed in Schafer (2019). The model shows that only bare steel deck diaphragms with connections that have sufficient ductility and deformation capacity provide adequate inelastic diaphragm performance – thus leading to special seismic detailing requirements. For the subset of cyclically tested diaphragms that meet the special seismic detailing requirements the tested subsystem ductility and system overstrength are established (Schafer 2019). To establish the diaphragm system ductility an additional correction is provided for the reduction in ductility of a roof that experiences varying shear across its width, compared with a cantilever diaphragm test which is under constant shear (O'Brien et al. 2017, Schafer 2019). From the system ductility and overstrength the diaphragm force reduction factor R_s was developed based on μ -R relations using the method documented in ATC-19.

C12.10.4 Alternative Diaphragm Design Provisions for One-Story Structures with Flexible Wood Structural Panel Diaphragms and Rigid Vertical Elements.

Section 12.10.4 introduces diaphragm seismic design provisions for one-story structures combining flexible diaphragms with rigid vertical elements. This approach is based on numerical studies conducted as part of the development of the 2015 guideline document *Seismic Design of Rigid Wall-Flexible Diaphragm Buildings: An Alternate Procedure* (FEMA P-1026). The numerical studies and the resulting seismic design methodology specifically recognized the dynamic response of rigid wall-flexible diaphragm structures as being dominated by dynamic response of and inelastic behavior in the diaphragm. While the most common occurrences of this structure type are the concrete tilt-up and masonry “big-box” structures, the rigid vertical element terminology of this section recognizes a wider range of vertical elements with which this methodology is permitted to be used.

Section 12.10.4.1 imposes a series of limitations, intended to restrict use of the methodology to flexible diaphragm-rigid vertical element structures consistent with the FEMA P-1026 basis.

Item 1 requires that when these alternative provisions are used, they be used in both orthogonal directions. Performance of diaphragms designed using a mix of different design provisions for each orthogonal direction has not been studied, and so resulting seismic performance is not known.

Item 2 limits use to wood structural panel or bare steel deck diaphragms, consistent with the recommendations of the FEMA P-1026 document.

Item 2 limits wood structural panel diaphragms to those designed in accordance with the AWC SDPWS standard (AWC, 2014). The Item 2 reference to AWC SDPWS tables further limits use to wood structural panel sheathing fastened to wood framing members or fastened to wood nailers (e.g. wood nailers attached to steel open-web joists) with nailing as specified in the SDPWS diaphragm tables. This is intended to limit fastening to nailed diaphragms and the nail types and nail patterns specified in the table. The FEMA P-1026 wood numerical studies were conducted using hysteretic descriptions derived from testing of diaphragms using full-length common nails based on the SDPWS tables. The performance of wood diaphragms using alternative fasteners and boundary members (chords, collectors, ledgers) has not been studied.

Dynamic testing of SDPWS diaphragms using short nails meeting the minimum embedment requirements of the SDPWS tables is not readily available at this time. Early APA testing of diaphragms with short nails (APA, 1966, 2007) showed little change in strength or displacement ductility. As a result, the use of short nails in diaphragm construction is not prohibited. This is, however, very narrowly limited to the nails specified in the SDPWS table, where shorter nail shank lengths can be justified by the alternate methods of construction provisions of IBC Section 104.11. It is not intended to carry over to other nail types or other fastener types (staples, screws, etc.).

Direct attachment of wood structural panel diaphragm sheathing to perimeter structural steel ledgers using power-actuated fasteners (PAFs) is believed to be very common in concrete and masonry wall buildings. Although approval of this type of fastener falls under the alternative methods of construction provisions of the building code, it is appropriate to note that the use of PAFs at the perimeter is of lesser concern when using the Section 12.10.4 diaphragm design method because amplified shear forces in the boundary zone reduce the inelastic deformation demands at the diaphragm perimeter. Therefore wood diaphragm use of PAFs in combination with steel members at the diaphragm boundary is not prohibited. This is, however, very narrowly limited to PAFs at the diaphragm perimeter in the amplified shear zone, and where the PAFs can be justified by the alternate methods of construction provisions of IBC Section 104.11.

For bare steel deck diaphragms, Item 2 references the recently developed steel deck design and detailing provisions of AISI S400 and provisions of AISI S310.

Item 3 prohibits use of this methodology where materials installed over the diaphragm would add significant diaphragm stiffness. This limitation is included because where such materials are used the diaphragm period and therefore seismic forces would not be appropriately estimated by this section, and the diaphragm may no longer qualify as flexible. Prohibited materials include concrete and similar materials (e.g. vermiculite concrete, cellular concrete, gypsum concrete, etc.), that provide significant stiffness and impede diaphragm deflection. Other toppings of potential concern include rigid insulation board, if bonded to the sheathing, and spray foam, as the bonding caused by these types of materials can impede the fastener behavior that is fundamental to deflection of diaphragms. Available testing of polyisocyanurate board attached with screws indicates an initial increase in stiffness only at very low load levels, beyond which the board does not affect strength or stiffness of the diaphragm; as a result it is considered acceptable to use this system. The wording used for Item 3 is taken from Section 12.3.1.1 because of the very similar intent of both sections. Where isolated pads of concrete occur on the bare steel deck (such as for roof top equipment) the engineer will need to judge whether the concrete pads reduce the flexibility of the diaphragm such that the diaphragm falls outside of the intent of Section 12.10.4.

Item 4 prohibits use with horizontal irregularities including torsional and diaphragm discontinuity irregularities. These configurations generate forces in diaphragms outside of those studied in the FEMA P-

1026 numerical studies, and the force levels and amplified shear boundary zones may not be appropriate with these irregularities.

Re-entrant corners are specifically permitted in structures designed using these seismic design forces. Re-entrant corners are believed to be prevalent in the existing building stock, and so anticipated to be common in buildings to be constructed under these provisions in the future. Because these diaphragms are dominated by shear deformation, it is judged that reentrant corners will not influence building seismic performance in a manner that would make use of these provisions inappropriate. Vertical irregularities are not addressed because use of the section is limited to one-story buildings.

Horizontal irregularity Table 12.3-1 triggers two design requirements for structures in SDCs D, E and F that have re-entrant corners. The first is the Section 12.3.3.4 requirement for increasing diaphragm collector design forces determined per Section 12.10.1; new Section 12.10.4.2.6 identifies this requirement as not being applicable because design per 12.10.4 requires use of an overstrength factor, and therefore the design forces fall under the exception to Section 12.3.3.4. The second references Table 12.6-1 limitations on analytical procedures; this requirement will not affect the one-story structures intended to fall under Section 12.10.4 provisions, as they will always be significantly below the 160-foot height limit of Table 12.6-1.

Item 5 requires that rectangular buildings with interior vertical elements or buildings with non-rectangular plan configurations be broken down into a series of rectangular sections for purposes of diaphragm design. Buildings to which this methodology might be applied are often not completely rectangular in plan, and often combine both long and short diaphragm spans. This provision requires that each section of diaphragm be defined as spanning between boundaries consisting of either vertical elements or collectors, with each span referred to as a diaphragm segment. Figure C12.10.4-1a illustrates diaphragm segments for transverse seismic forces, with each segment supported on all sides by concrete or masonry walls. Figure C12.10.4-1b illustrates the same concept, with two building plans in which, for transverse design, the diaphragm segments span to a combination of walls and collectors. The Item 5 limitation would also prohibit application to non-rectangular diaphragm segments such as triangular, trapezoidal or curved configurations; this is because of the more complex response of these configurations, and the difficulty in defining the effective diaphragm span and resulting diaphragm period. See Figure C12.10.4-2.

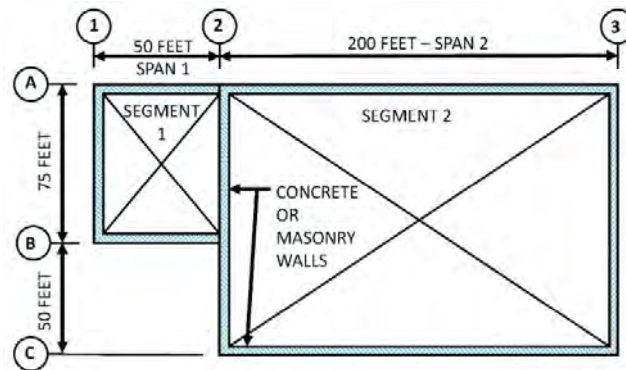

Figure C12.10.4-1a. Structure in plan view, divided into rectangular diaphragm segments for purposes of transverse seismic design. Note that identification of different segments will be required for longitudinal diaphragm forces.

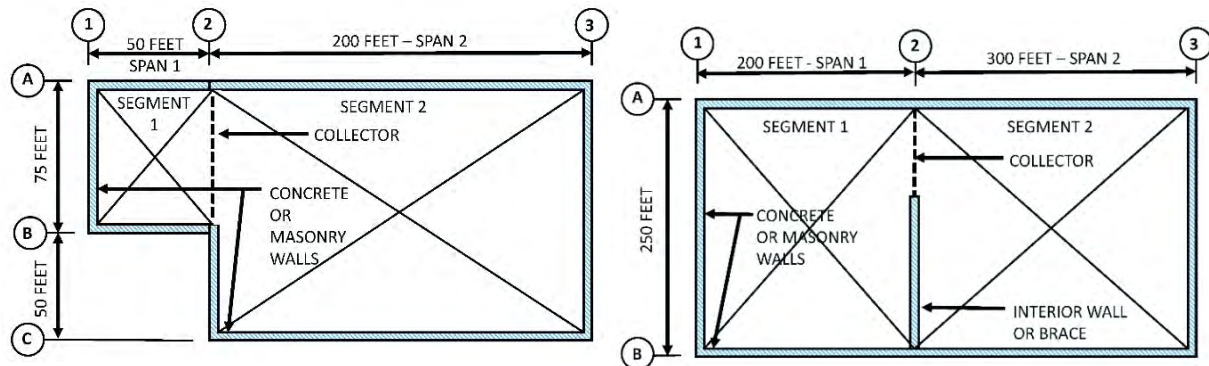

Figure C12.10.4-1b. Structures in plan view, divided into rectangular diaphragm segments for purposes of transverse seismic design. The Line 2 collector serves as a boundary between diaphragm segments for transverse direction loading. Note that identification of different segments will be required for longitudinal diaphragm forces in the building on the left.



Figure C12.10.4-2. Example of a structure with non-rectangular diaphragm that is beyond the scope of the Section 12.10.4 provisions.

Item 6 limits the vertical elements to systems that are inherently rigid for in-plane forces. This list functions as a definition of rigid vertical elements for purposes of Section 12.10.4. The list is in lieu of the FEMA P-1026 recommended minimum ratio of three between the fundamental period of the diaphragm and vertical elements. Limitation by system was identified to be the easiest and most direct way to address this criterion. See the FEMA P-1026 document for further discussion. The modifiers ordinary, intermediate, and special are not included for the vertical elements, with the intent that all types are sufficiently rigid and therefore permitted.

For Item 6, questions have arisen as to why steel and composite concentric braced frames are included in the scope and why buckling restrained braced frames (BRBFs) are not. The criteria established and studied during development of FEMA P-1026 required that the diaphragm calculated period be at least three times the period of the vertical elements. When considering wood structural panel and bare steel deck diaphragms, one-story concentric braced frames designed in accordance with the requirements of ASCE 7 and adopted material standards will very clearly categorically meet this criteria, and are therefore included in the scope

of these provision. Because BRBFs designed in accordance with adopted standards tend to have longer periods (more in line with steel moment frames), it is believed that they will generally not meet the FEMA P-1026 criteria, and are therefore excluded from the scope of these provisions. The drafters of the Section 12.10.4 provisions believed it important to use Item 6 to limit use to vertical elements to those where use of the provisions is perceived to be of benefit.

Item 7 serves as a reminder that the provisions of Section 12.10.4 address only design of the diaphragm, and it is not intended or permitted that these force levels also be used for the vertical elements of the seismic force-resisting system. Vertical elements are to be designed using the equivalent lateral force procedures of Section 12.8, except when designed in accordance with the two-stage analysis procedure of Section 12.2.3.2.2.

Section 12.10.4.2.1 provides new equations 12.10-15, 12.10-16a and 12.10-16b, to be used in place of Eq. (12.10-1) for calculation of diaphragm design forces. These equations incorporate the diaphragm approximate period, T_{diaph} . Where T_{diaph} is greater than T_s , this will permit C_s to be defined by the descending velocity-controlled portion of the response acceleration spectrum, thereby reducing diaphragm design forces. This is a distinct deviation from past design practices where seismic forces for diaphragm design were determined exclusively based on the approximate period and response modification factor of the vertical elements of the seismic force-resisting system. It is not necessary to set a lower bound on C_s , because the numerical studies for FEMA P-1026 investigated C_s values below the lower bound of Eq. (12.10-2) and found acceptable performance. Eq. (12.10-2) is provided primarily to guard against the higher diaphragm forces associated with higher mode shapes of tall multi-story buildings; however, the numerical studies for FEMA P-1026's single story building methodology saw limited participation of these higher modes and no reason to maintain this lower bound with these provisions.

Seismic response modification coefficient, R_{diaph} , is provided for both wood and bare steel deck roof diaphragms. The selected values for wood diaphragms and bare steel deck diaphragms with mechanical fasteners are based on studies reported in FEMA P-1026 (2015) and Koliou et al. (2015a,b). Based on the work of Schafer (2019) bare steel deck diaphragms were separated into two classes: diaphragms meeting special seismic detailing requirements where ductile diaphragm performance can be reliably provided are given an $R_{diaph}=4.5$, and other diaphragms where ductility is not required due to design forces representing near-elastic response, which are given an $R_{diaph}=1.5$. The special seismic detailing requirements are found in AISI S400.

Section 12.10.4.2.2 modifies the diaphragm shear forces determined per Sec. 12.10.4.2.1 for all diaphragms in an effort to manage the diaphragm's inelastic behavior. In larger diaphragm segments with spans of 100 feet or more, the provisions create an amplified shear boundary zone at the supported ends of the diaphragm segment span. This boundary zone is strengthened to reduce the inelastic demand within this zone, and push inelastic behavior to the interior of the diaphragm segment. FEMA P-1026 studies found that the strengthening of the diaphragm segment's ends resulted in broadly distributed inelastic behavior towards the diaphragm segment interior and significantly improved diaphragm performance. This also served to move inelastic demand away from the diaphragm-to-vertical element interface, where it can be most damaging and most greatly affect structural performance.

Small diaphragm segments with spans less than 100 feet have limited width available to distribute inelastic behavior; thus the amplification of diaphragm shears over the full diaphragm segment serves to limit inelastic behavior overall. The FEMA P-1026 numerical studies did not investigate diaphragm segment spans of less than 100 feet. The studies did, however, find a trend of the margin against collapse reducing with reduced diaphragm segment span, and the collapse margins at 100 feet approaching the minimum acceptance criteria. As a result the amplified shear force level is required throughout the diaphragm segment for spans less than 100 feet. It is recognized that the different treatment of diaphragms based on being above or below the 100 foot span introduces a step function into the design process; while ideally this step function would not

exist, it is necessary based on information currently available, and likely to have limited impact on design as the primary use of the methodology is intended to be diaphragms with spans greater than 100 feet.

When using this design procedure, it is important that strengthening of the diaphragm using amplified shear zones be limited to the zones prescribed by Section 12.10.4. Similarly it is important that the diaphragm interior fastening zones be designed and constructed to minimize excess fastening and therefore excess shear capacity. There is a wide spread belief that putting in more fasteners is always better, but in this case putting in more fasteners could result in reduced performance. This caution applies equally to wood structural panel and bare steel deck diaphragms.

Section 12.10.4.2.3 makes clear that chords are to be designed for the diaphragm design forces of Sec. 12.10.4.2.1, rather than the amplified forces of Sec. 12.10.4.2.2.

Section 12.10.4.2.4 makes clear that collectors and their connections to vertical elements are to be designed for the diaphragm design forces of Section 12.10.4.2.1, and in SDC D through F, amplified by an overstrength factor, $\Omega_{0\text{-diaph}}$, of 2 which was determined as a part the FEMA P-1026 numerical studies.

Section 12.10.4.2.5 provides a diaphragm deflection amplification factor, $C_{d\text{-diaph}}$, intended to be used where the seismic design provisions currently require calculation of deflection. The calculation of diaphragm deflections is specified to use the seismic design forces of Section 12.10.4.2.1; it is not intended that the forces used for calculation of diaphragm deflections include the shear amplifications of Section 12.10.4.2.2. No new uses or checks of deflection are intended to be imposed by Section 12.10.4 provisions. The $C_{d\text{-diaph}}$ factor has been derived from the FEMA P-1026 non-linear response history analysis (NLRHA) studies in conformance with FEMA P-695 procedures (developed for vertical elements of the seismic force-resisting system) with some modifications. According to FEMA P-695, vertical systems with typical damping are assigned a deflection amplification factor, C_d , equal to the response modification factor, R . For the case where bare steel deck diaphragms with special seismic detailing and wood diaphragms are designed according to Section 12.10.4, a deflection amplification factor, $C_{d\text{-diaph}}$ of 3.0 (less than R_{diaph} of 4.5) is deemed appropriate for several reasons: 1) the boundary zones are designed for 1.5 times the design shear value equating to R_{diaph} of 3.0 at the boundaries, 2) inelastic deformations in diaphragms concentrate at the diaphragm perimeter and at transitions in strength and stiffness (e.g. transitions in nailing patterns) leaving large portions of the diaphragm elastic, and 3) numerical studies underlying FEMA P-1026 found that the ratio of median design basis earthquake drift to yield drift (approximation of predicted drift) was between 1.4 and 2.9 with an average value of 2.1 suggesting that $C_{d\text{-diaph}}$ of 3.0 is conservative. See additional discussion at the end of the Section 12.10.4 commentary regarding calculation of diaphragm deflections and evaluation of deflection implications. For bare steel deck diaphragms not meeting the special seismic detailing requirements, the diaphragm deflection amplification factor is set to 1.5 in recognition of the near-elastic seismic demands being used for design.

Section 12.10.4.2.6 identifies two items affecting typical design that are not intended to be applicable when using Section 12.10.4. The Table 12.2-1 adjustment of vertical system Ω_0 for purposes of diaphragm design does not apply, as it is not consistent with the Sec. 12.10.4 formulation of diaphragm design forces. For Item 2, Sec. 12.3.3.4 could potentially be triggered when using Sec. 12.10.4 for a reentrant corner irregularity. It is clarified that modification of diaphragm design forces per Sec. 12.3.3.4 is not required. This is because per Section 12.10.4.2.4, the collectors and their connections to vertical elements are required to be designed for seismic loads including overstrength, meaning that Section 12.3.3.4 would never apply.

Additional considerations regarding diaphragm deflection calculation and acceptability. The following discussion provides the user with a general discussion of diaphragm deflections calculated in accordance with ASCE 7 Chapter 12 and SDPWS procedures, as well as those predicted by the FEMA P-1026 numerical studies, and their impact on seismic performance.

Design Diaphragm Deflection Calculation using SDPWS Engineered Design Methods. FEMA P-1026 provides design examples of a diaphragm with a 400 foot span and 200 foot width using common engineered design practice and SDPWS. FEMA P-1026 Chapter 3 provides a design example of the diaphragm using Section 12.10.1 diaphragm forces. FEMA P-1026 Chapters 5 and 6 provide a parallel design example using the new provisions of Section 12.10.4. Using Section 12.10.1 diaphragm design forces and a C_d of 4 consistent with an intermediate precast shear wall, the estimated maximum diaphragm deflection is 29 inches using the 3-term equation of SDPWS Section 4.2.2. Using Section 12.10.4 diaphragm design forces, the prescribed C_d of 3.0, and the design assumptions used in the FEMA P-1026 examples, the estimated maximum diaphragm deflection is 19 inches. Depending on calculation assumptions and calculation methods, it is anticipated that design engineers might calculate maximum diaphragm deflection as being anywhere between 10 and 19 inches. The 10 to 19 inches is a relative estimated displacement between the foundation and roof diaphragm at diaphragm mid-span, which will be a maximum imposed drift on the vertical elements of the gravity system. The primary contributions to roof diaphragm deflection come from the shear deformation of the wood structural panel diaphragm (combined nail slip and panel shear deformation) and flexural deformation from tension and compression of the chord member.

Numerical Studies Using NLRHA. Numerical studies used as the basis for FEMA P-1026 provide data on analytical predictions of average peak diaphragm deflections. Diaphragm drift ratios published in Koliou et al, (2015a, 2015b) are average peak ratios for the FEMA P-695 ground motion suite, scaled to $S_{DS}=1.0$. The published diaphragm drift ratios correspond to an average peak roof deflection of seven inches for the Chapter 3 example of the 400 foot span and 200 foot wide diaphragm designed for Section 12.10.1 forces. The published diaphragm drift ratios correspond to an average peak roof deflection of ten inches for a structure designed using a method close to but not exactly matching Section 12.10.4 (the design of this similar building model used a period that combined diaphragm and shear wall period, modestly increasing the period, lowering the design forces, and lowering diaphragm stiffness).

The user will notice that the SDPWS engineered design estimate of peak diaphragm deflection of 19 inches (or the range of 10 to 19 inches) is generally larger than the NLRHA analytically predicted deflections of seven and ten inches. A few reasons potentially contribute to this disparity. First, the FEMA P-1026 calculation conservatively computed the diaphragm's flexural deflection based on a single steel angle chord; however, numerous other building elements will engage as inadvertent chord elements including concrete and masonry walls, wall reinforcing and roof structure continuous ties, significantly reducing the flexural contribution to the deflection. Second, the 3-term deflection equation of SDPWS Section 4.2.2 overestimates the diaphragm deflection compared to the more accurate 4-term equation in the SDPWS Commentary when design shears are below strength level, and when nail spacing varies between different sides of the sheathing panels. Third, the nail slip contribution of the SDPWS diaphragm deflection equation is conservatively based on considering only the larger "nail spacing at other panel edges"; however, significant amounts of additional stiffness are contributed by the tighter "continuous edge nailing" in the direction of loading. Fourth, interior regions of each nailing zone have significantly more stiffness than assumed by the SDPWS diaphragm deflection procedure due to the stiffness nonlinearity of nail slippage. And lastly, the selection of $C_d = 3.0$ is potentially conservative as well. Finally, it is understood that the NLRHA, while a best available tool, provides approximate results and is most reliable for study of relative or approximate behavior, and not absolute determination of deflection. It is anticipated that actual deflection of diaphragms for most buildings of interest would fall in a range between the SDPWS engineered design and NLRHA values. Diaphragm deflections calculated using SDPWS engineered design methods are anticipated to conservatively estimate deflections.

Deflection of diaphragms is limited by Section 12.12.2, which requires that deflection be limited such that attached elements retain structural integrity. There are two primary aspects of structural integrity that should be checked. The first is the ability of the concrete or masonry walls (or other vertical elements) to maintain support of the prescribed loads through their out-of-plane rotation. Where gravity columns have rotational

fixity at their top or bottom, the ability of the columns to support gravity loads in the displaced configuration should also be evaluated. Diaphragm deflection causes second order moments in these elements which should be considered in conjunction with axial forces. The second is the ability of the connections within the gravity system to maintain strength as the vertical elements rock and rotate relative to the horizontal diaphragm; detailed discussion follows. Additionally, interior full-height partitions or demising walls and other nonstructural components may suffer from racking or connection failure.

Consideration of typical roof system connections to the vertical elements can provide insight into the ability of gravity load carrying systems to withstand estimated roof diaphragm deflections. This discussion is affected, however, by whether the NLRHA analytically predicted diaphragm deflections or the SDPWS estimated deflections are used. Using the higher predicted mid-diaphragm deflection of 10 inches from the FEMA P-1026 NLRHA numerical studies, and story heights of 20 and 30 feet, this would create a gap of between one-third and one-half inch between an exterior wall and a twelve inch deep ledger and joist, as seen in Figure 12.10.4-3(a) for a wood-framed roof system. This amount of deformation can reasonably be taken up at several different interfaces within this connection without connection failure being likely. Similarly for wood system girder supports (Figure 12.10.4-3(b)) and interior columns (Figure 12.10.4-3(c)), the connections should be able to withstand this level of deflection. As the diaphragm deflection is increased to approximately 19 inches based on SDPWS calculations, the gaps increase to between two-thirds and 1 inch for the joists, which is approaching but likely not reaching gap levels that could potentially unseat rafters from hangers and cause damage to ledgers that are susceptible to cross-grain tension failure. Higher wall deflections or shorter wall heights would create gaps that could potentially push these connections to failure, and so deserve detailed consideration during design.

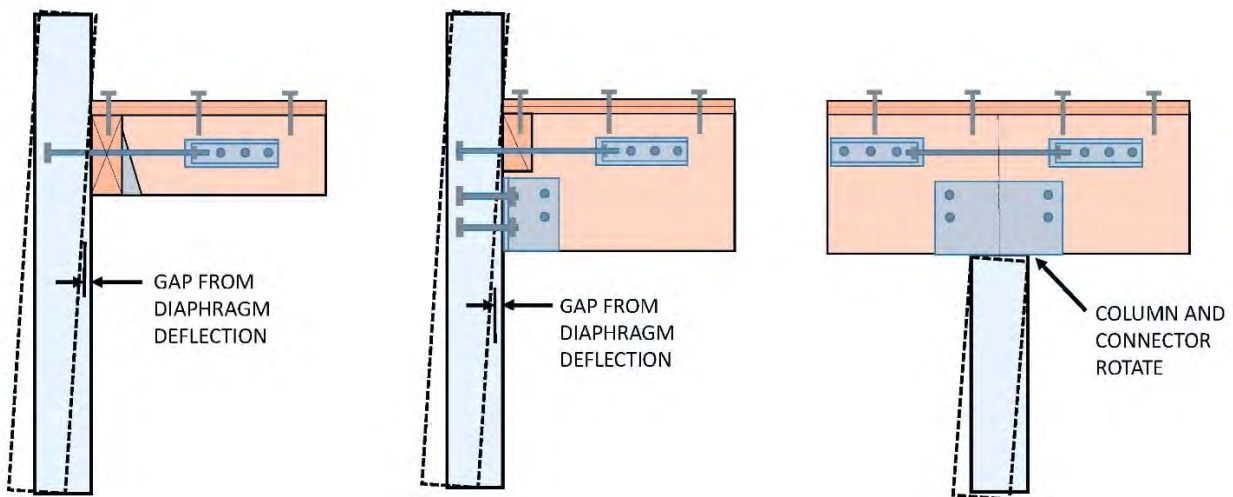

Figure C12.10.4-4. Steel open-web joist framed, wood sheathed diaphragm connections (a) joist to perimeter concrete or masonry wall, (b) joist girder to perimeter concrete or masonry wall, and (c) joist girder to interior column.

In addition to structural integrity considerations, global structural stability is a separate consideration where, the diaphragm deflection's contribution may lead to potential $P\Delta$ instability of the system as a whole. As the roof mass horizontally translates and the gravity system rotates, secondary forces and moments develop potentially leading to instability. Section 12.8.7 provides a methodology using a stability coefficient θ to determine whether the secondary effects are significant enough to require consideration; however, this section was developed expressly for buildings where the deformation is associated primarily with the vertical system, not the horizontal diaphragm. Never the less, the provisions can be adapted by considering P_x as the building weight tributary to the diaphragm (diaphragm weight plus half the rotating wall weight) and Δ as the weighted average diaphragm deflection. This approach is illustrated in FEMA P-1026.

The designer is reminded that diaphragms with openings are permitted to be designed per Sec. 12.10.4, provided that the openings do not trigger a horizontal irregularity. Design for forces around openings is required per Sec. 12.10 and the material design standard.

The designer is reminded that diaphragm deflection causes leaning of structural wall elements, including concrete and masonry walls, creating a p-delta effect and out-of-plane wall bending moment. This effect should be considered in the wall design.

The designer is also reminded that seismic forces for the design of subdiaphragms serving as anchorage of concrete or masonry walls remains per Sec. 12.11.

C12.11 STRUCTURAL WALLS AND THEIR ANCHORAGE

As discussed in Section C1.4, structural integrity is important not only in earthquake-resistant design but also in resisting high winds, floods, explosion, progressive failure, and even such ordinary hazards as foundation settlement. The detailed requirements of this section address wall-to-diaphragm integrity.

C12.11.1 Design for Out-of-Plane Forces.

Because they are often subjected to local deformations caused by material shrinkage, temperature changes, and foundation movements, wall connections require some degree of ductility to accommodate slight movements while providing the required strength.

Although nonstructural walls are not subject to this requirement, they must be designed in accordance with Chapter 13.

C12.11.2 Anchorage of Structural Walls and Transfer of Design Forces into Diaphragms or Other Supporting Structural Elements.

There are numerous instances in U.S. earthquakes of tall, single-story, and heavy walls becoming detached from supporting roofs, resulting in collapse of walls and supported bays of roof framing (Hamburger and McCormick 2004). The response involves dynamic amplification of ground motion by response of the vertical system and further dynamic amplification from flexible diaphragms. The design forces for Seismic Design Category D and higher have been developed over the years in response to studies of specific failures. It is generally accepted that the rigid diaphragm value is reasonable for structures subjected to high ground motions. For a simple idealization of the dynamic response, these values imply that the combined effects of inelastic action in the main framing system supporting the wall, the wall (acting out of plane), and the anchor itself correspond to a reduction factor of 4.5 from elastic response to an MCE_R motion, and therefore the value of the response modification coefficient, R , associated with nonlinear action in the wall or the anchor itself is 3.0. Such reduction is generally not achievable in the anchorage itself; thus, it must come from yielding elsewhere in the structure, for example, the vertical elements of the seismic force-resisting system, the diaphragm, or walls acting out of plane. The minimum forces are based on the concept that less yielding occurs with smaller ground motions and less yielding is achievable for systems with smaller values of R which are permitted in structures assigned to Seismic Design Categories B and C. The minimum value of R in structures assigned to Seismic Design Category D, except cantilever column systems and light-frame walls sheathed with materials other than wood structural panels, is 3.25, whereas the minimum values of R for Categories B and C are 1.5 and 2.0, respectively.

Where the roof framing is not perpendicular to anchored walls, provision needs to be made to transfer both the tension and sliding components of the anchorage force into the roof diaphragm. Where a wall cantilevers above its highest attachment to, or near, a higher level of the structure, the reduction factor based on the height within the structure, $(1 + 2z/h)/3$, may result in a lower anchorage force than appropriate. In such

an instance, using a value of 1.0 for the reduction factor may be more appropriate.

C12.11.2.1 Wall Anchorage Forces.

Diaphragm flexibility can amplify out-of-plane accelerations so that the wall anchorage forces in this condition are twice those defined in Section 12.11.1.

C12.11.2.2 Additional Requirements for Anchorage of Concrete or Masonry Structural Walls to Diaphragms in Structures Assigned to Seismic Design Categories C through F**C12.11.2.2.1 Transfer of Anchorage Forces into Diaphragm.**

This requirement, which aims to prevent the diaphragm from tearing apart during strong shaking by requiring transfer of anchorage forces across the complete depth of the diaphragm, was prompted by failures of connections between tilt-up concrete walls and wood panelized roof systems in the 1971 San Fernando earthquake.

Depending on diaphragm shape and member spacing, numerous suitable combinations of subdiaphragms, continuous tie elements, and smaller sub-subdiaphragms connecting to larger subdiaphragms and continuous ties are possible. The configurations of each subdiaphragm (or sub-subdiaphragm) provided must comply with the simple 2.5-to-1 length-to-width ratio, and the continuous tie must have adequate member and connection strength to carry the accumulated wall anchorage forces. The 2.5-to-1 aspect ratio is applicable to subdiaphragms of all materials, but only when they serve as part of the continuous tie system.

C12.11.2.2.2 Steel Elements of Structural Wall Anchorage System.

A multiplier of 1.4 has been specified for strength design of steel elements to obtain a fracture strength of almost 2 times the specified design force (where ϕ_t is 0.75 for tensile rupture).

C12.11.2.2.3 Wood Diaphragms.

Material standards for wood structural panel diaphragms permit the sheathing to resist shear forces only; use of diaphragm sheathing to resist direct tension or compression forces is not permitted. Therefore, seismic out-of-plane anchorage forces from structural walls must be transferred into framing members (such as beams, purlins, or subpurlins) using suitable straps or anchors. For wood diaphragms, it is common to use local framing and sheathing elements as subdiaphragms to transfer the anchorage forces into more concentrated lines of drag or continuity framing that carry the forces across the diaphragm and hold the building together. Figure C12.11-1 shows a schematic plan of typical roof framing using subdiaphragms.

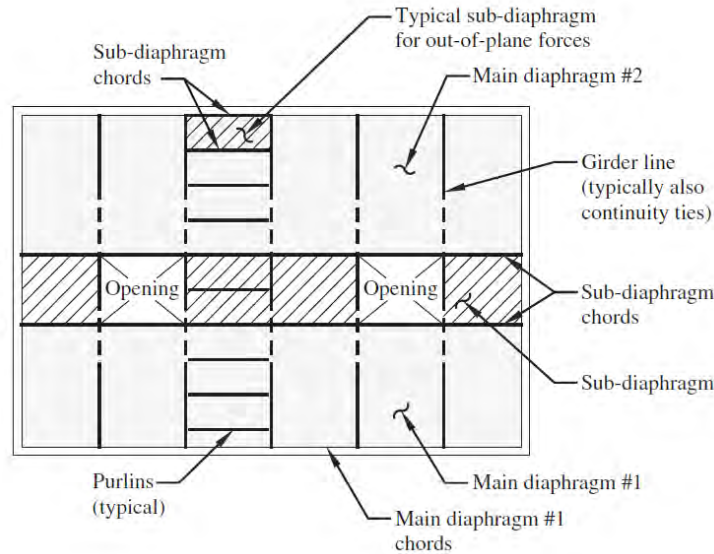

FIGURE C12.11-1 Typical Subdiaphragm Framing

Fasteners that attach wood ledgers to structural walls are intended to resist shear forces from diaphragm sheathing attached to the ledger that act longitudinally along the length of the ledger but not shear forces that act transversely to the ledger, which tend to induce splitting in the ledger caused by cross-grain bending. Separate straps or anchors generally are provided to transfer out-of-plane wall forces into perpendicular framing members.

Requirements of Section 12.11.2.2.3 are consistent with requirements of AWC SDPWS, SDPWS-15 (2014) Section 4.1.5.1 but also apply to wood use in diaphragms that may fall outside the scope of AWC SDPWS. Examples include use of wood structural panels attached to steel bar joists or metal deck attached to wood nailers.

C12.11.2.2.4 Metal Deck Diaphragms.

In addition to transferring shear forces, metal deck diaphragms often can resist direct axial forces in at least one direction. However, corrugated metal decks cannot transfer axial forces in the direction perpendicular to the corrugations and are prone to buckling if the unbraced length of the deck as a compression element is large. To manage diaphragm forces perpendicular to the deck corrugations, it is common for metal decks to be supported at 8- to 10-ft (2.4- to 3.0-m) intervals by joists that are connected to walls in a manner suitable to resist the full wall anchorage design force and to carry that force across the diaphragm. In the direction parallel to the deck corrugations, subdiaphragm systems are considered near the walls; if the compression forces in the deck become large relative to the joist spacing, small compression reinforcing elements are provided to transfer the forces into the subdiaphragms.

C12.11.2.2.5 Embedded Straps.

Steel straps may be used in systems where heavy structural walls are connected to wood or steel diaphragms as the wall-to-diaphragm connection system. In systems where steel straps are embedded in concrete or masonry walls, the straps are required to be bent around reinforcing bars in the walls, which improve their ductile performance in resisting earthquake load effects (e.g., the straps pull the bars out of the wall before the straps fail by pulling out without pulling the reinforcing bars out). Consideration should be given to the probability that light steel straps have been used in past earthquakes and have developed cracks or fractures at the wall-to-diaphragm framing interface because of gaps in the framing adjacent to the walls.

C12.11.2.2.6 Eccentrically Loaded Anchorage System.

Wall anchors often are loaded eccentrically, either because the anchorage mechanism allows eccentricity or because of anchor bolt or strap misalignment. This eccentricity reduces the anchorage connection capacity and hence must be considered explicitly in design of the anchorage. Figure C12.11-2 shows a one-sided roof-to-wall anchor that is subjected to severe eccentricity because of a misplaced anchor rod. If the detail were designed as a concentric two-sided connection, this condition would be easier to correct.

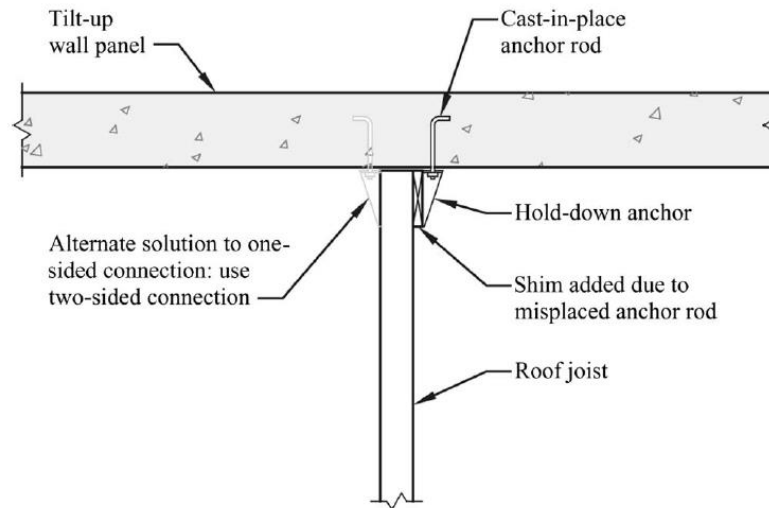

FIGURE C12.11-2 Plan View of Wall Anchor with Misplaced Anchor Rod

C12.11.2.2.7 Walls with Pilasters.

The anchorage force at pilasters must be calculated considering two-way bending in wall panels. It is customary to anchor the walls to the diaphragms assuming one-way bending and simple supports at the top and bottom of the wall. However, where pilasters are present in the walls, their stiffening effect must be taken into account. The panels between pilasters are typically supported along all panel edges. Where this support occurs, the reaction at the top of the pilaster is the result of two-way action of the panel and is applied directly to the anchorage supporting the top of the pilaster. The anchor load at the pilaster generally is larger than the typical uniformly distributed anchor load between pilasters. Figure C12.11-3 shows the tributary area typically used to determine the anchorage force for a pilaster.

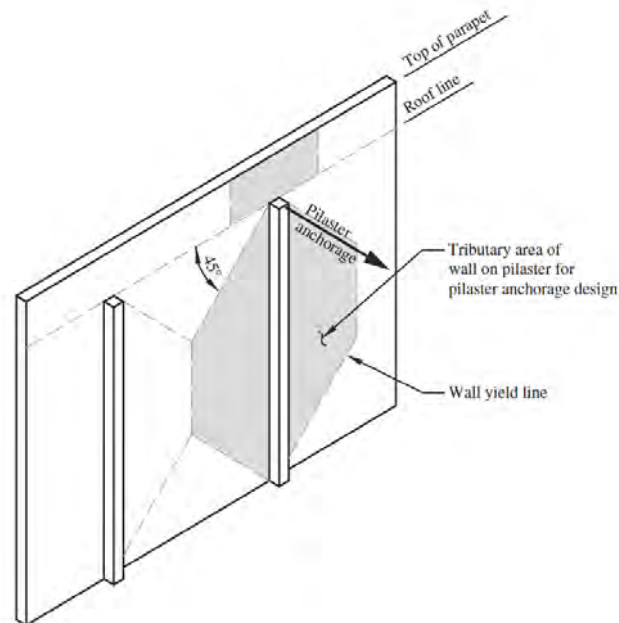

FIGURE C12.11-3 Tributary Area Used to Determine Anchorage Force at Pilaster

Anchor points adjacent to the pilaster must be designed for the full tributary loading, conservatively ignoring the effect of the adjacent pilaster.

C12.12 DRIFT AND DEFORMATION

As used in the standard, deflection is the absolute lateral displacement of any point in a structure relative to its base, and design story drift, Δ , is the difference in deflection along the height of a story (i.e., the deflection of a floor relative to that of the floor below). The drift, Δ , is calculated according to the procedures of Section 12.8.6. (Sections 12.9.2 and 16.1 give procedures for calculating displacements for modal response spectrum and linear response history analysis procedures, respectively; the definition of Δ in Section 11.3 should be used).

Calculated story drifts generally include torsional contributions to deflection (i.e., additional deflection at locations of the center of rigidity at other than the center of mass caused by diaphragm rotation in the horizontal plane). The provisions allow these contributions to be neglected where they are not significant, such as in cases where the calculated drifts are much less than the allowable story drifts, Δ_a , no torsional irregularities exist, and more precise calculations are not required for structural separations (see Sections C12.12.3 and C12.12.4).

The deflections and design story drifts are calculated using the design earthquake ground motion, which is two-thirds of the risk-targeted maximum considered earthquake (MCE_R) ground motion. The resulting drifts are therefore likely to be underestimated.

The design base shear, V , used to calculate Δ is reduced by the response modification coefficient, R . Multiplying displacements by the deflection amplification factor, C_d , is intended to correct for this reduction and approximate inelastic drifts corresponding to the design response spectrum unreduced by R . However, it is recognized that use of values of C_d less than R underestimates deflections (Uang and

Maarouf 1994). Also Sections C12.8.6.2 and C12.9.1.4 deal with the appropriate base shear for computing displacements.

For these reasons, the displacements calculated may not correspond well to (MCE_R) ground motions. However, they are appropriate for use in evaluating the structure's compliance with the story drift limits put forth in Table 12.12-1 of the standard.

There are many reasons to limit drift; the most significant are to address the structural performance of member inelastic strain and system stability and to limit damage to nonstructural components, which can be life-threatening. Drifts provide a direct but imprecise measure of member strain and structural stability. Under small lateral deformations, secondary stresses caused by the P-delta effect are normally within tolerable limits (see Section C12.8.7). The drift limits provide indirect control of structural performance.

Buildings subjected to earthquakes need drift control to limit damage to partitions, shaft and stair enclosures, glass, and other fragile nonstructural components. The drift limits have been established without regard to economic considerations such as a comparison of present worth of future repairs with additional structural costs to limit drift. These are matters for building owners and designers to address.

The allowable story drifts, Δ_a , of Table 12.12-1 reflect the consensus opinion of the ASCE 7 Committee taking into account the life-safety and damage control objectives described in the aforementioned commentary. Because the displacements induced in a structure include inelastic effects, structural damage as the result of a design-level earthquake is likely. This notion may be seen from the values of Δ_a stated in Table 12.12-1. For other structures assigned to Risk Category I or II, the value of Δ_a is $0.02h_{sx}$, which is about 10 times the drift ordinarily allowed under wind loads. If deformations well in excess of Δ_a were to occur repeatedly, structural elements of the seismic force-resisting system could lose so much stiffness or strength that they would compromise the safety and stability of the structure.

To provide better performance for structures assigned to Risk Category III or IV, their allowable story drifts, Δ_a , generally are more stringent than for those assigned to Risk Category I or II. However, those limits are still greater than the damage thresholds for most nonstructural components. Therefore, though the performance of structures assigned to Risk Category III or IV should be improved, there may be considerable damage from a design-level earthquake.

The allowable story drifts, Δ_a , for structures a maximum of four stories above the base are relaxed somewhat, provided that the interior walls, partitions, ceilings, and exterior wall systems have been designed to accommodate story drifts. The type of structure envisioned by footnote *d* in Table 12.12-1 would be similar to a prefabricated steel structure with metal skin.

The values of Δ_a set forth in Table 12.12-1 apply to each story. For some structures, satisfying strength requirements may produce a system with adequate drift control. However, the design of moment-resisting frames and of tall, narrow shear walls or braced frames often is governed by drift considerations. Where design spectral response accelerations are large, seismic drift considerations are expected to control the design of midrise buildings.

C12.12.3 Structural Separation.

This section addresses the potential for impact from adjacent structures during an earthquake. Such conditions may arise because of construction on or near a property line or because of the introduction of separations within a structure (typically called "seismic joints") for the purpose of permitting their independent response to earthquake ground motion. Such joints may effectively eliminate irregularities and large force transfers between portions of the building with different dynamic properties.

The standard requires the distance to be “sufficient to avoid damaging contact under total deflection.” It is recommended that the distance be computed using the square root of the sum of the squares of the lateral deflections. Such a combination method treats the deformations as linearly independent variables. The deflections used are the expected displacements (e.g., the anticipated maximum inelastic deflections including the effects of torsion and diaphragm deformation). Just as these displacements increase with height, so does the required separation. If the effects of impact can be shown not to be detrimental, the required separation distances can be reduced.

For rigid shear wall structures with rigid diaphragms whose lateral deflections cannot be reasonably estimated, the NEHRP provisions (FEMA 2009a) suggest that older code requirements for structural separations of at least 1 in. (25 mm) plus one-half in. (13 mm) for each 10 ft (3 m) of height above 20 ft (6 m) be followed.

C12.12.4 Members Spanning between Structures.

Where a portion of the structure is seismically separated from its support, the design of the support requires attention to ensure that support is maintained as the two portions move independently during earthquake ground motions. To prevent local collapse due to loss of gravity support for members that bridge between the two portions, the relative displacement must not be underestimated. Design Earthquake Displacements may be insufficient for this purpose. The provision thus requires that Maximum Considered Earthquake Displacements be used and that the absolute sum of displacements of the two portions be used instead of a modal combination, such as with Eq. (12.12-2), which would represent a probable value.

It is recognized that displacements so calculated are likely to be conservative. However, the consequences of loss of gravity support are likely to be severe, and some conservatism is deemed appropriate.

C12.12.5 Deformation Compatibility for Seismic Design Categories D through F.

In regions of high seismicity, many designers apply ductile detailing requirements to elements that are intended to resist seismic forces but neglect such practices for nonstructural components, or for structural components that are designed to resist only gravity forces but must undergo the same lateral deformations as the designated seismic force-resisting system. Even where elements of the structure are not intended to resist seismic forces and are not detailed for such resistance, they can participate in the response and may suffer severe damage as a result. This provision requires the designer to provide a level of ductile detailing or proportioning to all elements of the structure appropriate to the calculated deformation demands at the Design Earthquake Displacement (δ_{DE}) and the associated story drift. The deflections calculated using Eq. (12.8-15) are multiplied by R/C_d to correct for likely underestimation of displacement by the equation. Multiplying by R/C_d corrects for the fact that values of R/C_d less than 1 underestimate deflections (FEMA-440 2005, Uang and Maarouf 1994). This provision may be accomplished by applying details in gravity members similar to those used in members of the seismic force-resisting system or by providing sufficient strength in those members, or by providing sufficient stiffness in the overall structure to preclude ductility demands in those members. Note that this evaluation is performed at two-thirds MCEr level. Many details can provide significant collapse-prevention deformation capacity beyond the range that corresponds to design limits in material standards. Engineers should be attuned to conditions in which this additional deformation capacity is unlikely, such as a sliding seated connection detail where a girder is supported on a wall or a pilaster, or a restrained connection where the imposed rotations could cause a failure.

In the 1994 Northridge earthquake, such participation was a cause of several failures. A preliminary reconnaissance report of that earthquake (EERI 1994) states the following:

Of much significance is the observation that six of the seven partial collapses (in modern precast concrete parking structures) seem to have been precipitated by damage to the gravity load system. Possibly, the combination of large lateral deformation and vertical load caused crushing in poorly confined columns that were not detailed to be part of the lateral load resisting system. Punching

shear failures were observed in some structures at slab-to-column connections, such as at the Four Seasons building in Sherman Oaks. The primary lateral load resisting system was a perimeter ductile frame that performed quite well. However, the interior slab-column system was incapable of undergoing the same lateral deflections and experienced punching failures.

This section addresses such concerns. Rather than relying on designers to assume appropriate levels of stiffness, this section explicitly requires that the stiffening effects of adjoining rigid structural and nonstructural elements be considered and that a rational value of member and restraint stiffness be used for the design of structural components that are not part of the seismic force-resisting system.

This section also includes a requirement to address shears that can be induced in structural components that are not part of the seismic force-resisting system because sudden shear failures have been catastrophic in past earthquakes.

The exception is intended to encourage the use of intermediate or special detailing in beams and columns that are not part of the seismic force-resisting system. In return for better detailing, such beams and columns are permitted to be designed to resist moments and shears from unamplified deflections. This design approach reflects observations and experimental evidence that well-detailed structural components can accommodate large drifts by responding inelastically without losing significant vertical load-carrying capacity.

C12.13 FOUNDATION DESIGN

C12.13.1 Design Basis.

In traditional geotechnical engineering practice, foundation design is based on allowable stresses, with allowable foundation load capacities, Q_{as} , for dead plus live loads based on limiting static settlements, which provides a large factor of safety against exceeding ultimate capacities. In this practice, allowable soil stresses for dead plus live loads often are increased arbitrarily by one-third for load combinations that include wind or seismic forces. That approach is overly conservative and not entirely consistent with the design basis prescribed in Section 12.1.5, since it is not based on explicit consideration of the expected strength and dynamic properties of the site soils. Strength design of foundations in accordance with Section 12.13.5 facilitates more direct satisfaction of the design basis.

Section 12.13.1.1 provides horizontal load effect, E_h , values that are used in Section 12.4.2 to determine foundation load combinations that include seismic effects. Vertical seismic load effects are still determined in accordance with Section 12.4.2.2.

Foundation horizontal seismic load effect values specified in Section 12.13.1.1 are intended to be used with horizontal seismic forces, Q_E , defined in Section 12.4.2.1.

C12.13.3 Foundation Load-Deformation Characteristics.

For linear static and dynamic analysis methods, where foundation flexibility is included in the analysis, the load-deformation behavior of the supporting soil should be represented by an equivalent elastic stiffness using soil properties that are compatible with the soil strain levels associated with the design earthquake motion. The strain-compatible shear modulus, G , and the associated strain-compatible shear wave velocity, v_s , needed for the evaluation of equivalent elastic stiffness are specified in Chapter 19 of the standard or can be based on a site-specific study. Although inclusion of soil flexibility tends to lengthen the fundamental period of the structure, it should not change the maximum period limitations applied when calculating the required base shear of a structure.

A mathematical model incorporating a combined superstructure and foundation system is necessary to assess the effect of foundation and soil deformations on the superstructure elements. Typically, frequency-independent linear springs are included in the mathematical model to represent the load-deformation characteristics of the soil, and the foundation components are either explicitly modeled (e.g., mat foundation supporting a configuration of structural walls) or are assumed to be rigid (e.g., spread footing supporting a column). In specific cases, a spring may be used to model both the soil and the foundation component (e.g., grade beams or individual piles).

For dynamic analysis, the standard requires a parametric evaluation with upper and lower bound soil parameters to account for the uncertainty in as-modeled soil stiffness and in situ soil variability and to evaluate the sensitivity of these variations on the superstructure. Sources of uncertainty include variability in the rate of loading, including the cyclic nature of building response, level of strain associated with loading at the design earthquake (or stronger), idealization of potentially nonlinear soil properties as elastic, and variability in the estimated soil properties. To a lesser extent, this variation accounts for variability in the performance of the foundation components, primarily when a rigid foundation is assumed or distribution of cracking of concrete elements is not explicitly modeled.

Commonly used analysis procedures tend to segregate the “structural” components of the foundation (e.g., footing, grade beam, pile, and pile cap) from the supporting (e.g., soil) components. The “structural” components are typically analyzed using standard strength design load combinations and methodologies, whereas the adjacent soil components are analyzed using allowable stress design (ASD) practices, in which earthquake forces (that have been reduced by R) are considered using ASD load combinations, to make comparisons of design forces versus allowable capacities. These “allowable” soil capacities are typically based on expected strength divided by a factor of safety, for a given level of potential deformations.

When design of the superstructure and foundation components is performed using strength-level load combinations, this traditional practice of using allowable stress design to verify soil compliance can become problematic for assessing the behavior of foundation components. The 2009 NEHRP provisions (FEMA 2009a) contain two resource papers (RP 4 and RP 8) that provide guidance on the application of ultimate strength design procedures in the geotechnical design of foundations and the development of foundation load-deformation characterizations for both linear and nonlinear analysis methods. Additional guidance on these topics is contained in ASCE 41 (2014b).

C12.13.4 Reduction of Foundation Overturning.

Since the vertical distribution of horizontal seismic forces prescribed for use with the equivalent lateral force procedure is intended to envelope story shears, the resulting base overturning forces can be exaggerated in some cases. (See Section C12.13.3.) Such overturning will be over-estimated where multiple vibration modes are excited, so a 25% reduction in overturning effects is permitted for verification of soil stability. This reduction is not permitted for inverted pendulum or cantilevered column type structures, which typically have a single mode of response.

Since the modal response spectrum analysis procedure more accurately reflects the actual distribution of base shear and overturning moment, the permitted reduction is reduced to 10%.

C12.13.5 Strength Design for Foundation Geotechnical Capacity.

This section provides guidance for determination of nominal strengths, resistance factors, and acceptance criteria when the strength design load combinations of Section 12.4.2 are used, instead of allowable stress load combinations, to check stresses at the soil–foundation interface.

C12.13.5.1.1 Soil Strength Parameters.

If soils are saturated or anticipated to become so, undrained soil properties might be used for transient seismic loading, even though drained strengths may have been used for static or more sustained loading.

For competent soils that are not expected to degrade in strength during seismic loading (e.g., due to partial or total liquefaction of cohesionless soils or strength reduction of sensitive clays), use of static soil strengths is recommended for determining the nominal foundation geotechnical capacity, Q_{ns} , of foundations. Use of static strengths is somewhat conservative for such soils because rate-of-loading effects tend to increase soil strengths for transient loading. Such rate effects are neglected because they may not result in significant strength increase for some soil types and are difficult to estimate confidently without special dynamic testing programs. The assessment of the potential for soil liquefaction or other mechanisms for reducing soil strengths is critical, because these effects may reduce soil strengths greatly below static strengths for susceptible soils.

The best estimated nominal strength of footings, Q_{ns} , should be determined using accepted foundation engineering practice. In the absence of moment loading, the ultimate vertical load capacity of a rectangular footing of width B and length L may be written as $Q_{ns} = q_c(BL)$, where q_c = ultimate soil bearing pressure.

For rigid footings subject to moment and vertical load, contact stresses become concentrated at footing edges, particularly as footing uplift occurs. Although the nonlinear behavior of soils causes the actual soil pressure beneath a footing to become nonlinear, resulting in an ultimate foundation strength that is slightly greater than the strength that is determined by assuming a simplified trapezoidal or triangular soil pressure distribution with a maximum soil pressure equal to the ultimate soil pressure, q_c , the difference between the nominal ultimate foundation strength and the effective ultimate strength calculated using these simplified assumptions is not significant.

Lateral resistance may be determined from test data, or by a combination of lateral bearing, lateral friction, and cohesion values. The lateral bearing values may represent values determined from the passive strength values of soil or rock, or they may represent a reduced “allowable” value determined to meet a defined deformation limit. Lateral friction values may represent side-friction values caused by uplift or movement of a foundation against soils, such as for pile uplift or a side friction caused by lateral foundation movement, or they may represent the lateral friction resistance that may be present beneath a foundation caused by the gravity weight of loads that is bearing upon the supporting material.

The lateral foundation geotechnical capacity of a footing may be assumed to be equal to the sum of the best estimated soil passive resistance against the vertical face of the footing plus the best estimated soil friction force on the footing base. The determination of passive resistance should consider the potential contribution of friction on the vertical face.

For piles, the best estimated vertical strength (for both axial compression and axial tensile loading) should be determined using accepted foundation engineering practice. The moment capacity of a pile group should be determined assuming a rigid pile cap, leading to an initial triangular distribution of axial pile loading from applied overturning moments. However, the full expected axial capacity of piles may be mobilized when computing moment capacity, in a manner analogous to that described for a footing. The strength provided in pile caps and intermediate connections should be capable of transmitting the best estimated pile forces to the supported structure. When evaluating axial tensile strength, consideration should be given to the capability of pile cap and splice connections to resist the factored tensile loads.

The lateral foundation geotechnical capacity of a pile group may be assumed to be equal to the best estimated passive resistance acting against the face of the pile cap plus the additional resistance provided by piles.

When the nominal foundation geotechnical capacity, Q_{ns} , is determined by in situ testing of prototype foundations, the test program, including the appropriate number and location of test specimens, should be provided to the authority having jurisdiction by a registered design professional, based on the scope and variability of geotechnical conditions present at the site.

C12.13.5.2 Resistance Factors.

Resistance factors, ϕ , are provided to reduce nominal foundation geotechnical capacities, Q_{ns} , to design foundation geotechnical capacities, ϕQ_{ns} , to verify foundation acceptance criteria. The values of ϕ recommended here have been based on the values presented in the AASHTO *LRFD Bridge Design Specifications* (2010). The AASHTO values have been further simplified by using the lesser values when multiple values are presented. These resistance factors account not only for unavoidable variations in design, fabrication, and erection, but also for the variability that often is found in site conditions and test methods (AASHTO 2010).

C12.13.5.3 Acceptance Criteria.

The design foundation geotechnical capacity, ϕQ_{ns} , is used to assess acceptability for the linear analysis procedures. The mobilization of ultimate capacity in nonlinear analysis procedures does not necessarily lead to unacceptable performance because structural deformations caused by foundation displacements may be tolerable. For the nonlinear analysis procedures, Section 12.13.3 also requires evaluation of structural behavior using parametric variation of foundation strength to identify potential changes in structural ductility demands.

C12.13.6 Allowable Stress Design for Foundation Geotechnical Capacity.

In traditional geotechnical engineering practice, foundation design is based on allowable stresses, with allowable foundation load capacities, Q_{as} , for dead plus live loads based on limiting static settlements, which provides a large factor of safety against exceeding ultimate capacities. In this practice, allowable soil stresses for dead plus live loads often are increased arbitrarily by one-third for load combinations that include wind or seismic forces. That approach may be both more conservative and less consistent than the strength design basis prescribed in Section 12.1.5, since it is not based on explicit consideration of the expected strength and dynamic properties of the site soils.

C12.13.7 Requirements for Structures Assigned to Seismic Design Category C**C12.13.7.1 Pole-Type Structures.**

The high contact pressures that develop between an embedded pole and soil as a result of lateral loads make pole-type structures sensitive to earthquake motions. Pole-bending strength and stiffness, the soil lateral bearing capacity, and the permissible deformation at grade level are key considerations in the design. For further discussion of pole–soil interaction, see Section C12.13.8.7.

C12.13.7.2 Foundation Ties.

One important aspect of adequate seismic performance is that the foundation system acts as an integral unit, not permitting one column or wall to move appreciably to another. To attain this performance, the standard requires that pile caps be tied together. This requirement is especially important where the use of deep foundations is driven by the existence of soft surface soils.

Multistory buildings often have major columns that run the full height of the building adjacent to smaller columns that support only one level; the calculated tie force should be based on the heavier column load.

The standard permits alternate methods of tying foundations together when appropriate. Relying on lateral soil pressure on pile caps to provide the required restraint is not a recommended method because ground motions are highly dynamic and may occasionally vary between structure support points during a design-level seismic event.

C12.13.7.3 Pile Anchorage Requirements.

The pile anchorage requirements are intended to prevent brittle failures of the connection to the pile cap under moderate ground motions. Moderate ground motions can result in pile tension forces or bending moments that could compromise shallow anchorage embedment. Loss of pile anchorage could result in increased structural displacements from rocking, overturning instability, and loss of shearing resistance at the ground surface. A concrete bond to a bare steel pile section usually is unreliable, but connection by means of deformed bars properly developed from the pile cap into concrete confined by a circular pile section is permitted.

C12.13.8 Requirements for Structures Assigned to Seismic Design Categories D through F**C12.13.8.1 Pole-Type Structures.**

See Section C12.13.7.1.

C12.13.8.2 Foundation Ties.

See Section C12.13.7.2. For Seismic Design Categories D through F, the requirement is extended to spread footings on soft soils (Site Class E or F).

C12.13.8.3 General Pile Design Requirement.

Design of piles is based on the same response modification coefficient, R , used in design of the superstructure; because inelastic behavior results, piles should be designed with ductility similar to that of the superstructure. When strong ground motions occur, inertial pile–soil interaction may produce plastic hinging in piles near the bottom of the pile cap, and kinematic soil–pile interaction results in bending moments and shearing forces throughout the length of the pile, being higher at interfaces between stiff and soft soil strata. These effects are particularly severe in soft soils and liquefiable soils, so Section 14.2.3.2.1 requires special detailing in areas of concern.

The shears and curvatures in piles caused by inertial and kinematic interaction may exceed the bending capacity of conventionally designed piles, resulting in severe damage. Analysis techniques to evaluate pile bending are discussed by Margason and Holloway (1977) and Mylonakis (2001), and these effects on concrete piles are further discussed by Sheppard (1983). For homogeneous, elastic media and assuming that the pile follows the soil, the free-field curvature (soil strains without a pile present) can be estimated by dividing the peak ground acceleration by the square of the shear wave velocity of the soil. Considerable judgment is necessary in using this simple relationship for a layered, inelastic profile with pile–soil interaction effects. Norris (1994) discusses methods to assess pile–soil interaction.

Where determining the extent of special detailing, the designer must consider variation in soil conditions and driven pile lengths, so that adequate ductility is provided at potentially high curvature interfaces. Confinement of concrete piles to provide ductility and maintain functionality of the confined core pile during and after the earthquake may be obtained by use of heavy spiral reinforcement or exterior steel liners.

C12.13.8.4 Batter Piles.

Partially embedded batter piles have a history of poor performance in strong ground shaking, as shown by Gerwick and Fotinos (1992). Failure of battered piles has been attributed to design that neglects loading on the piles from ground deformation or assumes that lateral loads are resisted by axial response of piles without regard to moments induced in the pile at the pile cap (Lam and Bertero 1990). Because batter piles are considered to have limited ductility, they must be designed using the load combinations including overstrength. Moment-resisting connections between pile and pile cap must resolve the eccentricities inherent in batter pile configurations. This concept is illustrated clearly by EQE Engineering (1991).

C12.13.8.5 Pile Anchorage Requirements.

Piles should be anchored to the pile cap to permit energy-dissipating mechanisms, such as pile slip at the pile–soil interface, while maintaining a competent connection. This section of the standard sets forth a capacity design approach to achieve that objective. Anchorages occurring at pile cap corners and edges should be reinforced to preclude local failure of plain concrete sections caused by pile shears, axial loads, and moments.

C12.13.8.6 Splices of Pile Segments.

A capacity design approach, similar to that for pile anchorage, is applied to pile splices.

C12.13.8.7 Pile–Soil Interaction.

Short piles and long slender piles embedded in the earth behave differently when subjected to lateral forces and displacements. The response of a long slender pile depends on its interaction with the soil considering the nonlinear response of the soil. Numerous design aid curves and computer programs are available for this type of analysis, which is necessary to obtain realistic pile moments, forces, and deflections and is common in practice (Ensoft 2004b). More sophisticated models, which also consider inelastic behavior of the pile itself, can be analyzed using general-purpose nonlinear analysis computer programs or closely approximated using the pile–soil limit state methodology and procedure given by Song et al. (2005).

Each short pile (with length-to-diameter ratios no more than 6) can be treated as a rigid body, simplifying the analysis. A method assuming a rigid body and linear soil response for lateral bearing is given in the current building codes. A more accurate and comprehensive approach using this method is given in a study by Czerniak (1957).

C12.13.8.8 Pile Group Effects.

The effects of groups of piles, where closely spaced, must be taken into account for vertical and horizontal response. As groups of closely spaced piles move laterally, failure zones for individual piles overlap and horizontal strength and stiffness response of the pile–soil system is reduced. Reduction factors or “*p*-multipliers” are used to account for these groups of closely spaced piles. For a pile center-to-center spacing of three pile diameters, reduction factors of 0.6 for the leading pile row and 0.4 for the trailing pile rows are recommended by Rollins et al. (1999). Computer programs are available to analyze group effects assuming nonlinear soil and elastic piles (Ensoft 2004a).

C12.13.9 Requirements for Foundations on Liquefiable Sites.

This new section provides requirements for foundations of structures that are located on sites that have been determined to have the potential to liquefy when subjected to Geomean Maximum Considered Earthquake ground motions. This section complements the requirements of Section 11.8, which provides requirements for geotechnical investigations in areas with significant seismic ground motion hazard with specific requirements for additional geotechnical information and recommendations for sites that have the potential to liquefy when subjected to the Geomean Maximum Considered Earthquake ground motion.

Before the 2010 edition of ASCE 7 (which was based on the *2009 NEHRP Recommended Seismic Provisions for New Buildings and Other Structures*, FEMA 2009a), the governing building code requirements for foundations where potentially liquefiable soil conditions were present was Chapter 18 of the International Building Code (ICC 2009). Chapter 18 of the IBC (ICC 2009) specified the use of the design earthquake (DE) ground motions for all structural and geotechnical evaluations for buildings. Chapter 18 of IBC (ICC 2012) references ASCE 7-10 (2010) and deletes reference to the DE. Chapter 11 of ASCE 7-10 (2010) has new requirements that specify that Maximum Considered Earthquake (MCE) rather than the DE ground motions should be used for geotechnical (liquefaction-related) evaluations that are specified in IBC (ICC 2009).

The reason that the change to MCE ground motions for liquefaction evaluations was made in ASCE 7-10 (2010) was to make the ground motions used in the evaluations consistent with the ground motions used as the basis for the design of structures. Starting with the 2000 edition of the IBC (ICC 2000), the ground motion maps provided in the code for seismic design were MCE mapped values and not DE values. Although design values for structures in the IBC are based on DE ground motions, which are two-thirds of the MCE, studies (FEMA 2009b) have indicated that structures designed for DE motions had a low probability of collapse at MCE level motions. However, these studies presumed nonliquefiable soil conditions. It should also be noted that most essential structures, such as hospitals, are required to be explicitly designed for MCE motions. Whereas ASCE 7-10 has specific requirements for MCE-level liquefaction evaluations, it has no specific requirements for foundation design when these conditions exist. This lack of clear direction was the primary reason for the development of this new section.

The requirements of this section, along with the seismic requirements of this standard, are intended to result in structure foundation systems that satisfy the performance goals stated in Section 1.1 of the 2009 *NEHRP Recommended Seismic Provisions for New Buildings and Other Structures* for structure sites that have been determined to be liquefiable per Section 11.8. They require mitigation of significant liquefaction-induced risks, either through ground improvement or structural measures, aimed at preventing liquefaction-induced building collapse and permitting the structure and its nonstructural system to satisfy the Section 1.1 performance goals. With the exception of Risk Category IV Essential Facilities, the provisions do not seek to control non-life-threatening damage to buildings that may occur as a result of liquefaction-induced settlement. For Risk Category IV Essential Facilities, the provisions seek to limit damage attributable to liquefaction to levels that would permit postearthquake use. For example, settlement is controlled to levels that would be expected to allow for continued operation of doors.

There is nothing in these provisions that is intended to preclude the Authority Having Jurisdiction from enacting more stringent planning regulations for building on sites susceptible to potential geologic hazards, in recognition of losses that may occur in the event of an earthquake that triggers liquefaction.

In the first paragraph of Section 12.13.9, it is stated that the foundation must also be designed to resist the effects of design earthquake seismic load effects assuming that liquefaction does not occur. This additional requirement is imposed since maximum seismic loads on a foundation during an earthquake can occur before liquefaction. This additional requirement provides assurance that the foundation will be adequate regardless of when liquefaction occurs during the seismic event.

Observed Liquefaction-Related Structural Damage in Past Earthquakes

Damage to structures from liquefaction-related settlement, punching failure of footings, and lateral spreading has been common in past earthquakes. Whereas total postliquefaction settlement values have varied from several inches to several feet (depending on the relative density and thickness of saturated sand deposits), differential settlements depend on the uniformity of site conditions and the depth of liquefied strata. For example, in the 1995 Kobe, Japan, earthquake, total settlements of 1.5 to 2.5 ft (0.46 to 0.76 m) were observed but with relatively small differential settlements.

In the 1989 Loma Prieta, California, earthquake, settlements of as much as 2 ft (0.61 m) and lateral spreading that ranged between 0.25 and 5 ft (0.08 and 1.5 m) were observed on the Moss Landing spit. The Monterey Bay Aquarium Research Institute's (MBARI's) technology building was supported on shallow foundation with ties and located some 30 ft (9.14 m) away from the edge of the Moss Landing South Harbor. Whereas 0.25 ft (0.08 m) of lateral spreading was measured at the MBARI building, it suffered only minor cracks. On the other hand, the Moss Landing Marine Lab (MLML) building was located on a different part of the spit where between 4 and 5 ft (1.22 and 1.52 m) of lateral spreading was measured. The MLML building, which was supported on shallow foundations without ties, collapsed as the building footings were pulled apart. The MBARI research pier, located at the harbor, across the street from the Technology Building, suffered no damage except for minor spalling at the underside of the concrete deck, where the 16-in. (406.4-mm) diameter cylindrical driven piles for the pier interfaced with the overlying concrete deck.

The 1999 Kocaeli, Turkey, earthquake provided numerous examples of the relationship between liquefaction-induced soil deformations and building and foundation damage in the city of Adapazari. Examples include a five-story reinforced concrete frame building on a mat foundation that settled about 0.5 ft (0.15 m) at one corner and 5 ft (1.5 m) at the opposite corner with related tilting associated with rigid body motion. Essentially no foundation or structural damage was observed. In contrast, several buildings on mat foundations underwent bearing capacity failures and overturned. The foundation soil strength loss, evidenced by bulging around the building perimeter, initiated the failures, as opposed to differential settlement caused by postliquefaction volume change in the former case history. In addition, lateral movements of building foundations were also observed. Movements were essentially rigid body for buildings on stiff mat foundations, and they led to no significant building damage. For example, a five-story building experienced about 1.5 ft (0.46 m) of settlement and 3 ft (0.91 m) of lateral displacement.

In the 2011 and 2012 Christchurch, New Zealand, earthquakes, significant differential settlement occurred for several buildings on spread footings. Values of differential settlement of 1 to 1.5 ft (0.31 to 0.46 m) were measured for three- to five-story buildings, resulting in building tilt of 2 to 3 deg. Structural damage was less for cases where relatively strong reinforced concrete ties between footings were used to minimize differential settlement. Footing punching failures also occurred leading to significant damage. For taller buildings on relatively rigid raft foundations, differential ground settlement resulted in building tilt, but less structural damage. In contrast, structures on pile foundations performed relatively well.

C12.13.9.1 Foundation Design.

Foundations are not allowed to lose the strength capacity to support vertical reactions after liquefaction. This requirement is intended to prevent bearing capacity failure of shallow foundations and axial load failure of deep foundations. Settlement in the event of such failures cannot be accurately estimated and has potentially catastrophic consequences. Such failures can be prevented by using ground improvement or adequately designed deep foundations.

Liquefaction-induced differential settlement can result from variations in the thickness, relative density, or fines content of potentially liquefiable layers that occur across the footprint of the structure. When planning a field exploration program for a potentially liquefiable site, where it is anticipated that shallow foundations may be used, the geotechnical engineer must have information on the proposed layout of the building(s) on the site. This information is essential to properly locating and spacing exploratory holes to obtain an appropriate estimate of anticipated differential settlement. One acceptable method for dealing with unacceptable liquefaction-induced settlements is by performing ground improvement. There are many acceptable methods for ground improvement.

C12.13.9.2 Shallow Foundations.

Shallow foundations are permitted where individual footings are tied together so that they have the same horizontal displacements, and differential settlements are limited or where the expected differential settlements can be accommodated by the structure and the foundation system. The lateral spreading limits provided in Table 12.13-2 are based on engineering judgment and are the judged upper limits of lateral spreading displacements that can be tolerated while still achieving the desired performance for each Risk Category, presuming that the foundation is well tied together. Differential settlement is defined as δ_v/L , where δ_v and L are illustrated for an example structure in Figure C12.13-1. The differential settlement limits specified in Table 12.13-3 are intended to provide collapse resistance for Risk Category II and III structures.

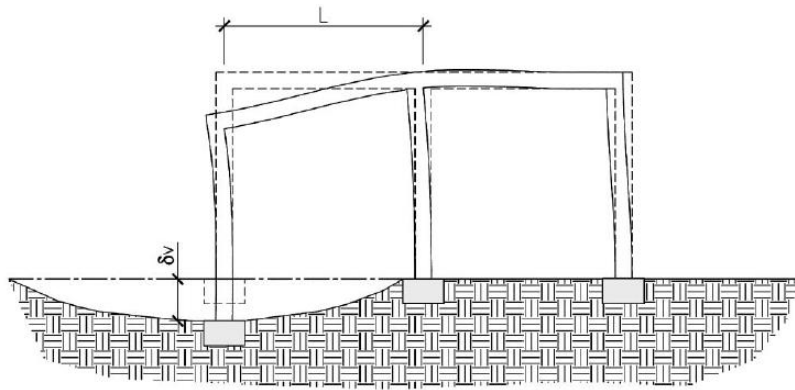

FIGURE C12.13-1 Example Showing Differential Settlement Terms δ_v and L

The limit for one-story Risk Category II structures with concrete or masonry structural walls is consistent with the drift limit in ASCE 41 (2014b) for concrete shear walls to maintain collapse prevention. The limit for taller structures is more restrictive because of the effects that the tilt would have on the floors of upper levels. This more restrictive limit is consistent with the “moderate to severe damage” for multistory masonry structures, as indicated in Boscardin and Cording (1989).

The limits for structures without concrete or masonry structural walls are less restrictive and are consistent with the drift limits in ASCE 41 (2014b) for high-ductility concrete frames to maintain collapse prevention. Frames of lower ductility are not permitted in Seismic Design Categories C and above, which are the only categories where liquefaction hazards need to be assessed.

The limits for Risk Category III structures are two-thirds of those specified for Risk Category II.

The limits for Risk Category IV are intended to maintain differential settlements less than the distortion that will cause doors to jam in the design earthquake. The numerical value is based on the median value of drift (0.0023) at the onset of the damage state for jammed doors developed for the ATC-58 project (ATC 2012), multiplied by 1.5 to account for the dispersion and scaled to account for the higher level of shaking in the MCE relative to the DE.

Shallow foundations are required to be interconnected by ties, regardless of the effects of liquefaction. The additional detailing requirements in this section are intended to provide moderate ductility in the behavior of the ties because the adjacent foundations may settle differentially. The tie force required to accommodate lateral ground displacement is intended to be a conservative assessment to overcome the maximum frictional resistance that could occur between footings along each column or wall line. The tie force assumes that the lateral spreading displacement occurs abruptly midway along the column or wall line. The coefficient of friction between the footings and underlying soils may be taken conservatively as 0.50. This requirement is intended to maintain continuity throughout the substructure in the event of lateral ground displacement affecting a portion of the structure. The required tie force should be added to the force determined from the lateral loads for the design earthquake in accordance with Sections 12.8, 12.9, 12.14, or Chapter 16.

C12.13.9.3 Deep Foundations.

Pile foundations are intended to remain elastic under axial loadings, including those from gravity, seismic, and downdrag loads. Since geotechnical design is most frequently performed using allowable stress design (ASD) methods, and liquefaction-induced downdrag is assessed at an ultimate level, the requirements state that the downdrag is considered as a reduction in the ultimate capacity. Since structural design is most

frequently performed using load and resistance factor design (LRFD) methods, and the downdrag is considered as a load for the pile structure to resist, the requirements clarify that the downdrag is considered as a seismic axial load, to which a factor of 1.0 would be applied for design.

The ultimate geotechnical capacity of the pile should be determined using only the contribution from the soil below the liquefiable layer. The net ultimate capacity is the ultimate capacity reduced by the downdrag load (Figure C12.13-2).

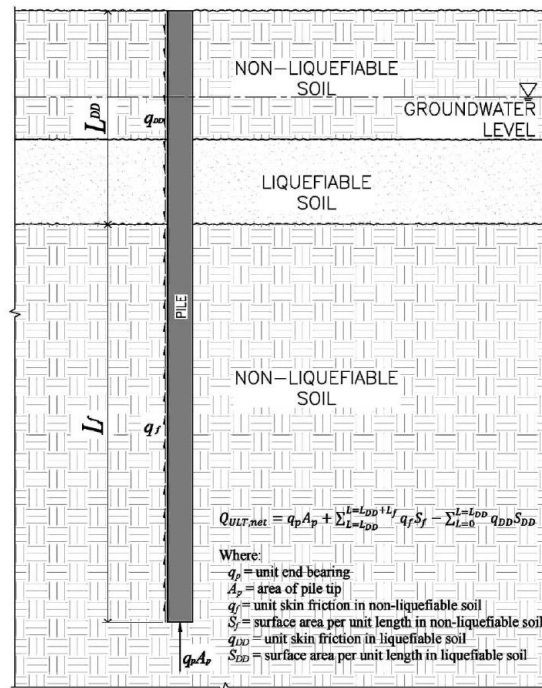

FIGURE C12.13-2 Determination of Ultimate Pile Capacity in Liquefiable Soils

Lateral resistance of the foundation system includes resistance of the piles as well as passive pressure acting on walls, pile caps, and grade beams. Analysis of the lateral resistance provided by these disparate elements is usually accomplished separately. In order for these analyses to be applicable, the displacements used must be compatible. Lateral pile analyses commonly use nonlinear soil properties. Geotechnical recommendations for passive pressure should include the displacement at which the pressure is applicable, or they should provide a nonlinear mobilization curve. Liquefaction occurring in near-surface layers may substantially reduce the ability to transfer lateral inertial forces from foundations to the subgrade, potentially resulting in damaging lateral deformations to piles. Ground improvement of surface soils may be considered for pile-supported structures to provide additional passive resistance to be mobilized on the sides of embedded pile caps and grade beams, as well as to increase the lateral resistance of piles. Otherwise, the check for transfer of lateral inertial forces is the same as for structures on nonliquefiable sites.

IBC (ICC 2012), Section 1810.2.1, requires that deep foundation elements in fluid (liquefied) soil be considered unsupported for lateral resistance until a point 5 ft (1.5 m) into stiff soil or 10 ft (3.1 m) into soft soil unless otherwise approved by the authority having jurisdiction on the basis of a geotechnical investigation by a registered design professional. Where liquefaction is predicted to occur, the geotechnical engineer should provide the dimensions (depth and length) of the unsupported length of the pile or should indicate if the liquefied soil will provide adequate resistance such that the length is considered laterally supported in this soil. The geotechnical engineer should develop these dimensions by performing an analysis of the nonlinear resistance of the soil to lateral displacement of the pile (i.e., p - y analysis).

Concrete pile detailing includes transverse reinforcing requirements for columns in ACI 318-14 (2014). This is intended to provide ductility within the pile similar to that required for columns.

Where permanent ground displacement is indicated, piles are not required to remain elastic when subjected to this displacement. The provisions are intended to provide ductility and maintain vertical capacity, including flexure-critical behavior of concrete piles.

The required tie force specified in Section 12.13.9.3.5 should be added to the force determined from the lateral loads for the design earthquake in accordance with Sections 12.8, 12.9, 12.14, or Chapter 16.

C12.14 SIMPLIFIED ALTERNATIVE STRUCTURAL DESIGN CRITERIA FOR SIMPLE BEARING WALL OR BUILDING FRAME SYSTEMS

C12.14.1 General.

In recent years, engineers and building officials have become concerned that the seismic design requirements in codes and standards, though intended to make structures perform more reliably, have become so complex and difficult to understand and implement that they may be counterproductive. Because the response of buildings to earthquake ground shaking is complex (especially for irregular structural systems), realistically accounting for these effects can lead to complex requirements. There is a concern that the typical designers of small, simple buildings, which may represent more than 90% of construction in the United States, have difficulty understanding and applying the general seismic requirements of the standard.

The simplified procedure presented in this section of the standard applies to low-rise, stiff buildings. The procedure, which was refined and tested over a five-year period, was developed to be used for a defined set of buildings deemed to be sufficiently regular in structural configuration to allow a reduction of prescriptive requirements. For some design elements, such as foundations and anchorage of nonstructural components, other sections of the standard must be followed, as referenced within Section 12.14.

C12.14.1.1 Simplified Design Procedure.

Reasons for the limitations of the simplified design procedure of Section 12.14 are as follows:

1. The procedure was developed to address adequate seismic performance for standard occupancies. Because it was not developed for higher levels of performance associated with structures assigned to Risk Categories III and IV, no Importance Factor (I_e) is used.
2. Site Class E and F soils require specialized procedures that are beyond the scope of the procedure.
3. The procedure was developed for stiff, low-rise buildings, where higher mode effects are negligible.
4. Only stiff systems where drift is not a controlling design criterion may use the procedure. Because of this limitation, drifts are not computed. The response modification coefficient, R , and the associated system limitations are consistent with those found in the general Chapter 12 requirements.
5. To achieve a balanced design and a reasonable level of redundancy, two lines of resistance are required in each of the two major axis directions. Because of this stipulation, no redundancy factor (ρ) is applied.
6. When combined with the requirements in items 7 and 8, this requirement reduces the potential for dominant torsional response.
7. Although concrete diaphragms may be designed for even larger overhangs, the torsional response of the system would be inconsistent with the behavior assumed in development of Section 12.14. Large overhangs for flexible diaphragm buildings can also produce a response that is inconsistent with the assumptions associated with the procedure.

8. Linear analysis shows a significant difference in response between flexible and rigid diaphragm behavior. However, nonlinear response history analysis of systems with the level of ductility present in the systems permitted in Table 12.14-1 for the higher Seismic Design Categories has shown that a system that satisfies these layout and proportioning requirements provides essentially the same probability of collapse as a system with the same layout but proportioned based on rigid diaphragm behavior (BSSC 2015). This procedure avoids the need to check for torsional irregularity, and calculation of accidental torsional moments is not required. Figure C12.14-1 shows a plan with closely spaced walls in which the method permitted in subparagraph (c) should be implemented. In that circumstance, the flexible diaphragm analysis would first be performed as if there were one wall at the location of the centroid of walls 4 and 5, then the force computed for that group would be distributed to walls 4 and 5 based on an assessment of their relative stiffnesses.
9. An essentially orthogonal orientation of lines of resistance effectively uncouples response along the two major axis directions, so orthogonal effects may be neglected.
10. Where the simplified design procedure is chosen, it must be used for the entire design in both major axis directions.
11. Because in-plane and out-of-plane offsets generally create large demands on diaphragms, collectors, and discontinuous elements, which are not addressed by the procedure, these irregularities are prohibited.
12. Buildings that exhibit weak-story behavior violate the assumptions used to develop the procedure.

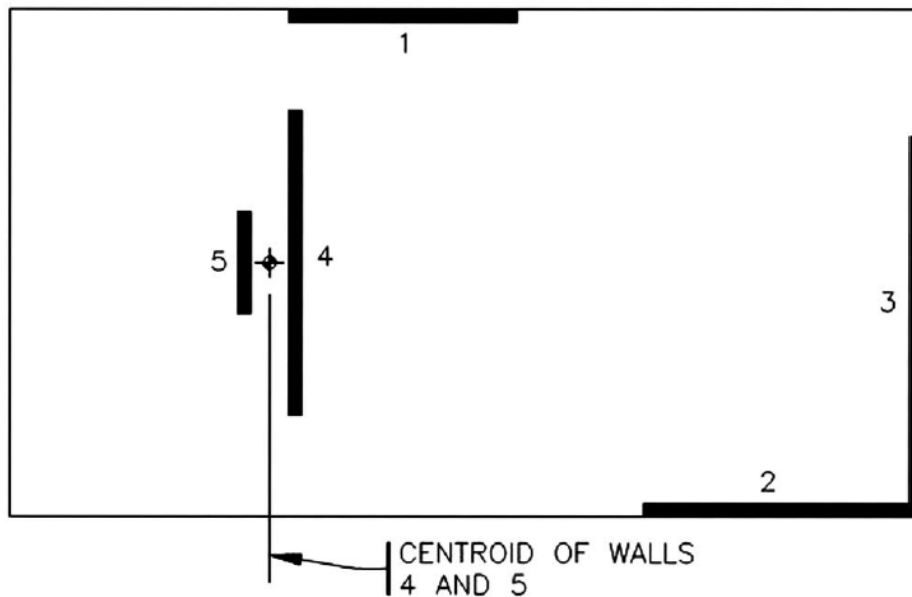

FIGURE C12.14-1 Treatment of Closely Spaced Walls

C12.14.3 Seismic Load Effects and Combinations.

The equations for seismic load effects in the simplified design procedure are consistent with those for the general procedure, with one notable exception: The overstrength factor (corresponding to Ω_0 in the general procedure) is set at 2.5 for all systems, as indicated in Section 12.14.3.2.1. Given the limited systems that can use the simplified design procedure, specifying unique overstrength factors was deemed unnecessary.

C12.14.7 DESIGN AND DETAILING REQUIREMENTS.

The design and detailing requirements outlined in this section are similar to those for the general procedure. The few differences include the following:

1. Forces used to connect smaller portions of a structure to the remainder of the structures are taken as 0.20 times the short-period design spectral response acceleration, S_{DS} , rather than the general procedure value of 0.133 (Section 12.14.7.1).
2. Anchorage forces for concrete or masonry structural walls for structures with diaphragms that are not flexible are computed using the requirements for nonstructural walls (Section 12.14.7.5).

C12.14.8 SIMPLIFIED LATERAL FORCE ANALYSIS PROCEDURE

C12.14.8.1 Seismic Base Shear.

The seismic base shear in the simplified design procedure, as given by Eq. (12.14-11), is a function of the short-period design spectral response acceleration, S_{DS} . The value for F in the base shear equation addresses changes in dynamic response for buildings that are two or three stories above grade plane (see Section 11.2 for definitions of “grade plane” and “story above grade plane”). As in the general procedure (Section 12.8.1.3), S_{DS} may be computed for short, regular structures with S_s taken as no greater than 1.5.

C12.14.8.2 Vertical Distribution.

The seismic forces for multistory buildings are distributed vertically in proportion to the weight of the respective floor. Given the slightly amplified base shear for multistory buildings, this assumption, along with the limit of three stories above grade plane for use of the procedure, produces results consistent with the more traditional triangular distribution without introducing that more sophisticated approach.

C12.14.8.5 Drift Limits and Building Separation.

For the simplified design procedure, which is restricted to stiff shear wall and braced frame buildings, drift need not be calculated. Where drifts are required (such as for structural separations and cladding design) a conservative drift value of 1% is specified.

REFERENCES

- American Association of State Highway and Transportation Officials (AASHTO). (2010). *LRFD bridge design specifications*, Washington, DC.
- ACI. (2014). “Building code requirements for structural concrete and commentary.” *ACI 318-14*, Farmington Hills, MI.
- ACI. (2018). “Building code requirements for structural concrete.” *ACI 318-19*, Public Review, Farmington Hills, MI. Published December 21, 2018.
- American Institute of Steel Construction (AISC). (2016). “Seismic provisions for structural steel buildings.” *AISC 341-10*, Chicago.
- American Plywood Association (APA). (1966). *1966 horizontal plywood diaphragm tests*. Laboratory Report 106. APA, Tacoma, WA.
- American Plywood Association (APA). (2000). “Plywood diaphragms.” *Research Report 138*, APA, Tacoma, WA.
- American Plywood Association (APA), (2007). *Diaphragms and shear walls, design/construction guide (Form L350A)*, APA The Engineered Wood Association, 2007

- Applied Technology Council (ATC). (1984), “Tentative provisions for the development of seismic regulations for buildings.” *ATC 3-06*, Redwood City, CA.
- Applied Technology Council (ATC). (1995). *Structural Response Modification Factors*, Applied Technology Council, Redwood City, CA
- Applied Technology Council (ATC). (2012), “Seismic performance assessment of buildings.” *ATC 58*, ATC Redwood City, CA.
- ASCE. (2000). “Seismic analysis of safety-related nuclear structures and commentary.” *ASCE 4-98*, ASCE Reston, VA.
- ASCE. (2003). “Minimum design loads for buildings and other structures.” *ASCE 7-02*, ASCE, Reston, VA.
- ASCE. (2010). “Minimum design loads for buildings and other structures.” *ASCE 7-10*, ASCE, Reston, VA.
- ASCE. (2014b). “Seismic evaluation and retrofit of existing buildings.” *ASCE 41-13*, ASCE, Reston, VA.
- ASCE/SEI. (2007). “Seismic rehabilitation of existing buildings.” *ASCE/SEI 41-06*, ASCE, Reston, VA.
- ASCE 7-16 (2019). “Minimum design loads and associated criteria for buildings and other structures,” *ASCE 7-16*, Supplement 2, American Society of Civil Engineers, Reston, VA.
- American Wood Council (AWC). (2008). “Special design provisions for wind and seismic.” *AWC SDPWS-2008*, AWC, Leesburg, VA.
- AWC (2014). “Special design provisions for wind and seismic.” *AWC SDPWS-1*, AW, Leesburg, VA.
- Boscardin, M. D., and Cording, E. J. (1989). “Building response to excavation-induced settlement.” *J. Geotech. Eng*, *ASCE*, *115(1)*, 1–21.
- Bruneau, M., Varma, A.H., Kizilarslan, E., Broberg, M., Shafaei, S., Seo, J., (2019). *R-Factors for coupled composite plate shear walls / concrete filled (CC-PSW/CF)*, Charles Pankow Foundation Report CPF#05-17, McLean, Virginia, 419pp.
- Building Seismic Safety Council (BSSC). (2015). *Development of simplified seismic design provisions, Working Group 1 Report: Simplifying Section 12.14*. National Institute of Building Sciences, Washington, DC.
- Charney, F. A., and Marshall, J. (2006). “A comparison of the Krawinkler and scissors models for including beam-column joint deformations in the analysis of moment-resisting frames.” *AISC Engrg. J.*, *43(1)*, 31–48.
- Chen, M., Pantoli, E. , Wang, X. , Astroza, R. , Ebrahimian, H. , Hutchinson, T. , et al. (2015). “Full-scale structural and nonstructural building system performance during earthquakes part I – specimen description, test protocol and structural response.” *Earthquake Spectr* , *32(2)*, 737–770.
- Choi, H., Erochko, J. , Christopoulos, C. , and Tremblay, R. (2008). “Comparison of the seismic response of steel buildings incorporating self-centering energy-dissipative braces, buckling restrained braces and moment-resisting frames.” *Research Report 05-2008*, University of Toronto, Canada.
- Chopra, A. K. (1995). *Structural dynamics*, Prentice Hall International Series in Civil Engineering, New York.
- Chopra, A. K. (2007a). *Dynamics of structures*, 4th Ed. Prentice Hall International Series in Civil Engineering, Upper Saddle River, NJ.
- Chopra, A. K. (2007b). *Structural dynamic* , Prentice Hall International Series in Civil Engineering, Upper Saddle River, N.J.
- Chopra, A. K., and Goel, R. K. (1991). “Evaluation of torsional provisions in seismic codes.” *J. Struct. Engrg* , *117(12)*, 3762–3782.

- Chopra, A. K., and Newmark, N. M. (1980). *Analysis. Design of earthquake resistant structures*, E. Rosenblueth, ed., John Wiley & Sons, New York.
- Czerniak, E. (1957). "Resistance to overturning of single, short piles." *J. Struct. Div*, 83(2), 1–25.
- Debock, D. J., Liel, A. B., Haselton, C. B., Hopper, J. D., and Henige, R. (2014). "Importance of seismic design accidental torsion requirements for building collapse," *Earthq. Engrg. Struct. Dyn.*, 43(6).
- De La Llera, J. C., and Chopra, A. K. (1994). "Evaluation of code accidental-torsion provisions from building records." *J. Struct. Engrg.*, 120(2), 597–616.
- Douglas Fir Plywood Association (DFPA). (1954). "Horizontal plywood diaphragm tests." *Laboratory Report 63a*. DFPA, Tacoma, WA.
- DFPA. (1963). "Lateral tests on plywood sheathed diaphragms." *Laboratory Report 55*. DFPA, Tacoma, WA.
- Earthquake Engineering Research Institute (EERI). (1994). "Northridge Earthquake, January 17, 1994: Preliminary reconnaissance report," *John F. Hall, ed., EERI, Oakland, CA*, 56–57.
- Ensoft, Inc. (2004a). *Computer program GROUP, Version 6.0: A program for the analysis of a group of piles subjected to axial and lateral loading, user's manual and technical manual*. Ensoft, Austin, TX.
- Ensoft, Inc. (2004b). *Computer program LPILE Plus, Version 5.0: A program for the analysis of piles and drilled shafts under lateral loads, user's manual and technical manual*. Ensoft, Austin, TX.
- EQE Engineering. (1991). "Structural concepts and details for seismic design." *UCRL-CR-106554*. Department of Energy, Washington, DC.
- EQE Incorporated. (1983). *The effects of the May 2, 1983, Coalinga, California, earthquake on industrial facilities*. EQE Inc., Newport Beach, CA.
- EQE. (1985). *Summary of the September 19, 1985, Mexico earthquake*. EQE Inc., Newport Beach, CA.
- EQE. (1986a). *Summary of the March 3, 1985, Chile earthquake*. EQE Inc., Newport Beach, CA.
- EQE. (1986b). *The effects of the March 3, 1985, Chile earthquake on power and industrial facilities*. EQE Inc., Newport Beach, CA.
- EQE. (1986c). *Power and industrial facilities in the epicentral area of the 1985 Mexico earthquake*. EQE Inc., Newport Beach, CA.
- EQE. (1987). *Summary of the 1987 Bay of Plenty, New Zealand, earthquake*. EQE Inc., Newport Beach, CA.
- Federal Emergency Management Agency (FEMA). (2009a). "NEHRP recommended seismic provisions for new buildings and other structures." *FEMA P-750*, Building Seismic Safety Council, FEMA, Washington, DC.
- FEMA. (2009b). "Quantification of building seismic performance factors." *FEMA P-695*, Applied Technology Council, FEMA, Washington, DC.
- FEMA. (2011). "Quantification of building seismic performance factors: Component equivalency methodology." *FEMA P-795*, Washington, DC.
- FEMA (2012) "Seismic performance assessment of buildings." *FEMA P-58*, Applied Technology Council, FEMA, Washington, DC.
- FEMA. (2013). "2009 NEHRP recommended seismic provisions: Design examples." *FEMA P-751CD*, Washington, DC
- FEMA P-695, (2009). *Quantification of building seismic performance factors*. Federal Emergency Management Agency, Washington, D.C.

- FEMA P-1026, 2015. *Seismic design of rigid wall-flexible diaphragm buildings: An alternate procedure*. Federal Emergency Management Agency, Washington, D.C.
- FEMA P-2012 (2018). “Assessing seismic performance of buildings with configuration irregularities,” Applied Technology Council, *FEMA P-2012*, Washington, DC. [ATC 123]
- FEMA.P-2082 (2020). *NEHRP recommended seismic provisions for new buildings and other structures*. Vol. II: Part 3 resource papers. “Resource Paper on Modal Response Spectrum Analysis Methods,” *FEMA P-2082*, Building Seismic Safety Council, Washington, D.C.
- Fleischman, R. B., Restrepo, J. I., Naito, C. J., Sause, R., Zhang, D. , and Schoettler, M. (2013). “Integrated analytical and experimental research to develop a new seismic design methodology for precast concrete diaphragms,” *J. Struct. Eng.*, *139*(7), 1192–1204.
- Gatto, K., and Uang, C.-M. (2002). *Cyclic response of woodframe shearwalls: Loading protocol and rate of loading effects*. Consortium of Universities for Research in Earthquake Engineering, Richmond, CA.
- Gerwick, B., Jr., and Fotinos, G. (1992). *Drilled piers and driven piles for foundations in areas of high seismicity*. SEAONC Fall Seminar, October 29, San Francisco.
- Goel, R. K., and Chopra, A. K. (1997). “Period formulas for moment-resisting frame buildings.” *J. Struct. Engrg* , *123*(11), 1454–1461.
- Goel, R. K., and Chopra, A. K. (1998). “Period formulas for concrete shear wall buildings.” *J. Struct. Engrg.*, *124*(4), 426–433.
- Grant, D., and Diaferia, R. (2012). “Assessing adequacy of spectrum matched ground motions for response history analysis.” *Earthq. Eng. Struct. Dyn* , *42*(9), 1265–1280.
- Gupta, A., and Krawinkler, H. (2000). “Dynamic P-delta effects for flexible inelastic steel structures.” *J. Struct. Engrg.*, *126*(1), 145–154.
- Hamburger, R. O., and McCormick, D. L. (2004). “Implications of the January 17, 1994, Northridge earthquake on tilt-up and masonry buildings with wood roofs.” Proc. 63rd Annual Convention, *Structural Engineers Association of California, Lake Tahoe, CA*, 243–255.
- Hancock, J. , Watson-Lamprey, J. , Abrahamson, N. A. , Bommer, J. J., Markatis, A. , McCoy, E., et al. (2006). “An improved method of matching response spectra of recorded earthquake ground motion using wavelets.” *J. Earthq. Eng.*, *10*(1), 67–89.
- International Conference of Building Officials (ICBO). (1988). *Uniform building code*, Whittier, CA.
- ICBO. (1994). *Uniform building code*, Whittier, CA.
- ICBO. (1997). *Uniform building code*, Whittier, CA.
- International Code Council (ICC). (2000). *International building code*, Country Club Hills, IL.
- ICC. (2009). *International building code*, Country Club Hills, IL.
- ICC. (2012). *International building code*, Country Club Hills, IL.
- ICC. (2015). *International building code*, Country Club Hills, IL.
- Kizilarlan, E., Seo, J., Broberg, M., Shafaei, S., Varma, A.H., Bruneau., M., (2018). *R-factors for coupled composite plate shear walls—concrete filled (Coupled-C-PSW/CF)*, Interim Project Report #2, Submitted to the Charles Pankow Foundation for CPF research grant #06-16.
- Kizilarlan, E., Seo, J., Broberg, M., Shafaei, S., Varma, A.H., Bruneau., M., (2019). *Seismic design coefficients and factors for coupled composite plate shear walls—concrete filled (Coupled-C-PSW/CF)*, to be published.

- Koliou, 2015a. Koliou, M., Filiatrault, A., Kelly, D., and Lawson, J., *Buildings with rigid walls and flexible diaphragms i: evaluation of current u.s. seismic provisions*, Journal of Structural Engineering, ASCE, 2015.
- Koliou, 2015b. Koliou, M., Filiatrault, A., Kelly, D., and Lawson, J., *Buildings with rigid walls and flexible diaphragms ii: evaluation of a new seismic design approach based on distributed diaphragm yielding*, Journal of Structural Engineering, ASCE, 2015.
- Lam, I., and Bertero, V. (1990). *A seismic design of pile foundations for port facilities*. Proc. POLA Seismic Workshop on Seismic Engineering, March 21–23, San Pedro, CA, Port of Los Angeles.
- Liew, J. Y. R., Chen, H. , and Shanmugam, N. E. (2001). “Inelastic analysis of steel frames with composite beams.” *J. Struct. Engrg.* , 127(2), 194–202.
- Lopez, O. A., and Cruz, M. (1996). “Number of modes for the seismic design of buildings.” *Earthq. Engrg. Struct. Dyn.*, 25(8), 837–856.
- Maniatakis, C.A., Psycharis, I.N. and Spyrakos, C.C. (2013). *Effect of higher modes on the seismic response and design of moment resisting rc frame structures*. Journal of Engineering Structures, Elsevier Ltd., 0141-0296/\$. <http://dx.doi.org/10.1016/j.jengstruct.2013.021>
- Margason, E., and Holloway, M. (1977). “Pile bending during earthquakes.” Proc. 6th World Conference on Earthquake Engineering, New Delhi.
- Menun, C., and Der Kiureghian, A. (1998). “A replacement for the 30%, 40%, and SRSS rules for multicomponent seismic analysis.” *Earthq. Spectra*, 14(1).
- Mylonakis, G. (2001). “Seismic pile bending at soil-layer interfaces.” *Soils and Found.*, 41(4), 47–58.
- National Institute of Standards and Technology (NIST). (2010). “Nonlinear structural analysis for seismic design: A guide for practicing engineers.” *Report NIST GCR 10-917-5*, Gaithersburg, MD.
- NIST. (2011). “Selecting and scaling earthquake ground motions for performing response-history analyses.” *NIST GCR 11-918-15*. Prepared by the NEHRP Consultants, Joint Venture for the National Institute of Standards and Technology, Gaithersburg, MD.
- Newmark, N. M., and Hall, W. J. (1982). *Earthquake spectra and design*, EERI Monograph Series, Earthquake Engineering Research Institute, Oakland, CA.
- Newmark, N. M., and Rosenblueth, E. (1971). *Fundamentals of earthquake engineering*, Prentice Hall, Englewood Cliff, NJ.
- Norris, G. M. (1994). *Seismic bridge pile foundation behavior*. Proc. Intl. Conf. on Design and Construction of Deep Foundations, Federal Highway Administration, Vol. 1.
- Paulay, T. (1997). “Are existing seismic torsion provisions achieving design aims?” *Earthq. Spectra*, 13(2), 259–280.
- Paulay, T., and Priestley, M. J. N. (1992). *Seismic design of reinforced concrete and masonry structures*. John Wiley & Sons, New York.
- Panagiotou, M., Restrepo, J. I., and Conte, J. P. (2011). “Shake-table test of a full-scale 7-story building slice. Phase I: Rectangular wall.” *J. Struct. Eng.*, 137(6), 691–704.
- Pugh, J.S., Lowes, L.N. and Lehman, D.E., (2017). “Accurate methods for elastic seismic demand analysis of reinforced concrete walled buildings.” *Journal of Structural Engineering, American Society of Civil Engineers*. 143(8).
- Rollins, K. M., Peterson, K. T., Weaver, T. J., and Sparks, A. E. (1999). *Static and dynamic lateral load behavior on a full-scale pile group in clay*. Brigham Young University, Provo, UT, and Utah Department of Transportation, Salt Lake City, June 23.

- Rosenblueth, E., and Contreras, H. (1977). "Approximate design for multicomponent earthquakes." *J. Engrg. Mech. Div*, 103(5), 881–893.
- Sanchez, J., Mohr, B., Harris, S. Aviram, A. and Goings, C., (2019). *Parametric study of steel moment frames considering foundation rocking*, Proceedings of the 16th World Conference on Earthquake Engineering, Santiago, Chile, January 2017.
- Schafer, (2019). "Research on the seismic performance of rigid wall flexible diaphragm buildings with bare steel deck diaphragms." *CFSRC Report 2019-2*.
- Schaffhausen, R., and Wegmuller, A. (1977). "Multistory rigid frames with composite girders under gravity and lateral forces." *AISC Engrg. J.*, 2nd Quarter.
- SDPWS, 2015. *Special design provisions for wind and seismic*. American Wood Council, American Wood Council, Leesburg, VA.
- Sheppard, D. A. (1983). "Seismic design of prestressed concrete piling." *PCI J*, 28(2), 20–49.
- Song, S. T., Chai, Y. H., and Hale, T. H. (2005). "Analytical model for ductility assessment of fixed-head concrete piles." *J. Struct. Engrg.*, 131(7), 1051–1059.
- Tauberg, N.A., Kolozvari, K., and Wallace, J.W. (2019). *Ductile reinforced concrete coupled walls: P695 study*. Draft Final Report (90%), Report No. SEERL 2019-XX, University of California, Los Angeles, Department of Civil and Environmental Engineering, 106pp.
- Uang, C.-M. , and Maarouf, A. (1994). "Deflection amplification factor for seismic design provisions." *J. Struct. Engrg.*, 120(8), 2423–2436.
- U.S. Nuclear Regulatory Commission. (2012). "Combining modal responses and spatial components in seismic response analysis," *Regulatory Guide 1.92*, Brookhaven National Laboratory, Upton, NY.
- Vamvatsikos, D. (2002). *Seismic performance, capacity and reliability of structures as seen through incremental dynamic analysis*. Ph.D. Dissertation, Stanford University, Palo Alto, CA.
- van de Lindt, J., Rammer, D., Line, P., Amini, M., Pei, S., and Popovski, M. *Determination of seismic performance factors for cross-laminated timber shear walls based on the fema P695 methodology*. USDA FPL & CSU, June 12, 2019.
- Wilson, E. L. (2000). *Three-dimensional static and dynamic analysis of structures*. Computers and Structures, Inc., Berkeley, CA.
- Wilson, E. L. (2004). *Static and dynamic analysis of structures*, Computers and Structures, Berkeley, CA.
- Wilson, E. L., Der Kiureghian, A., and Bayo, E. P. (1981). "A replacement for the SRSS method in seismic analysis." *Earthq. Engrg. Struct. Dyn.* 9(2), 187–194.
- Wilson, E. L., and Habibullah, A. (1987). "Static and dynamic analysis of multi-story buildings, including P-delta effects," *Earthq. Spectra* 3(2), 289–298.
- Wilson, E. L., and Penzien, J. (1972). "Evaluation of orthogonal damping matrices." *Int. J. Numer. Meth.*, 4, 5–10.

OTHER REFERENCES (NOT CITED)

- "Assessing adequacy of spectrum matched ground motions for response history analysis," *Earthq. Eng. Struct. Dyn.*, 42(9), 60T126560T–1280.
- Bernal, (1987). "Amplification factors for inelastic dynamic P-delta effects in earthquake analysis." *Earthq. Engrg. Struct. Dyn.*, 18, 60T63560T–681.
- California Geological Survey. (2008). *Special publication SP 117A–Guidelines for evaluation and mitigation of seismic hazards in California*.

- Charney, F. A. (1990). "Wind drift serviceability limit state design of multistory buildings." *J. Wind Engrg. Indust. Aerodyn.*, 36, 60T20360T–212.
- City of Newport Beach. (2012). "Minimum liquefaction mitigation measures," April 24.
- Degenkolb, G. H. J. (1987). "A study of the P-delta effect." *Earthq. Spectra*, 3(1).
- Geotechnical guidelines for buildings on liquefiable sites in accordance with the NBC 2005 for Greater Vancouver.* (2007). Task Force Report, May 8 <
<https://static1.squarespace.com/static/523c951be4b0728273e73d94/t/53234518e4b0556272c33257/1394820376117/2007+Task+Force+Report.pdf>>
- Griffis, L. (1993). *Serviceability limit states under wind load*. Engrg. J., Am. Inst. Steel Construction, First Quarter.
- International Conference of Building Officials (ICBO). (1988). "Uniform building code," *UBC-88*.
- Newmark, N. M., and Hall, W. J. (1978). "Development of criteria for seismic review of selected nuclear power plants," *NUREG/CR-0098*, U.S. Nuclear Regulatory Commission.
- Newmark, N. M., and Hall, W. J. (1982). *Earthquake Spectra and Design*, EERI Monograph Series, Earthquake Engineering Research Institute, Oakland, CA.
- NIST. (2010). "Nonlinear Structural Analysis for Seismic Design, A Guide for Practicing Structural Engineers," *Report Number NIST GCR 10-917-5*, National Institute of Standards and Technology, Gaithersburg, MD.
- NIST. (2011). "Selecting and Scaling Earthquake Ground Motions for Performing Response-History Analyses," *NIST GCR 11-918-15*. Prepared by the NEHRP Consultants Joint Venture for the National Institute of Standards and Technology, Gaithersburg, MD.
- Pantoli, E., Chen, M., Wang, X., Astroza, R., Mintz, S., Ebrahimian, H., et al. (2013). "BNCS Report #2: Full-scale structural and nonstructural building system performance during earthquakes and postearthquake fire-test results." Structural Systems Research Project Report Series, *SSRP 13/10*. University of California San Diego, La Jolla, CA.
- Post Tensioning Institute, *PTI DC10.5-Standard Requirements of the Design and Analysis of Post-Tensioned Concrete Foundations on Expansive Soils*, 2012.
- U.S. Nuclear Regulatory Commission. (1999). "Reevaluation of regulatory guidance on modal response combination methods for seismic response spectrum analysis." *NUREG/CR-6645*, Brookhaven National Laboratory, Upton, NY.
- Wilson, E. L., Suhawardy, I., and Habibullah, A. (1995). "A clarification of the orthogonal effects in a three-dimensional seismic analysis." *Earthq. Spectra*, 11(4).

COMMENTARY TO CHAPTER 13, SEISMIC DESIGN REQUIREMENTS FOR NONSTRUCTURAL COMPONENTS

C13.1 GENERAL

Chapter 13 defines minimum design criteria for architectural, mechanical, electrical, and other nonstructural systems and components, recognizing structure use, occupant load, the need for operational continuity, and the interrelation of structural, architectural, mechanical, electrical, and other nonstructural components. Nonstructural components are designed for design earthquake ground motions as defined in Section 11.2 and determined in Section 11.4.5 of the standard. In contrast to structures, which are implicitly designed for a low probability of collapse when subjected to the risk-targeted maximum considered earthquake (MCE_R) ground motions, there are no implicit performance goals associated with the MCE_R for nonstructural components. Performance goals associated with the design earthquake are discussed in Section C13.1.3.

Suspended or attached nonstructural components that could detach either in full or in part from the structure during an earthquake are referred to as falling hazards and may represent a serious threat to property and life safety. Critical attributes that influence the hazards posed by these components include their weight, their attachment to the structure, their failure or breakage characteristics (e.g., non-shatterproof glass), and their location relative to occupied areas (e.g., over an entry or exit, a public walkway, an atrium, or a lower adjacent structure). Architectural components that pose potential falling hazards include parapets, cornices, canopies, marquees, glass, large ornamental elements (e.g., chandeliers), and building cladding. In addition, suspended mechanical and electrical components (e.g., mixing boxes, piping, and ductwork) may represent serious falling hazards. Figs. C13.1-1 through C13.1-4 show damage to nonstructural components in past earthquakes.



FIGURE C13.1-1. Hospital Imaging Equipment That Fell from Overhead Mounts



FIGURE C13.1-2 Damaged Ceiling System



FIGURE C13.1-3 Collapsed Light Fixtures



FIGURE C13.1-4 Toppled Storage Cabinets

Components whose collapse during an earthquake could result in blockage of the means of egress deserve special consideration. The term “means of egress” is used commonly in building codes with respect to fire hazard. Egress paths may include intervening aisles, doors, doorways, gates, corridors, exterior exit balconies, ramps, stairways, pressurized enclosures, horizontal exits, exit passageways, exit courts, and yards. Items whose failure could jeopardize the means of egress include walls around stairs and corridors, veneers, cornices, canopies, heavy partition systems, ceilings, architectural soffits, light fixtures, and other ornaments above building exits or near fire escapes. Examples of components that generally do not pose a significant falling hazard include fabric awnings and canopies. Architectural, mechanical, and electrical components that, if separated from the structure, fall in areas that are not accessible to the public (e.g., into a mechanical shaft or light well) also pose little risk to egress routes.

For some architectural components, such as exterior cladding elements, wind design forces may exceed the calculated seismic design forces. Nevertheless, seismic detailing requirements may still govern the overall structural design. Where this is a possibility, it must be investigated early in the structural design process.

The seismic design of nonstructural components may involve consideration of non-seismic requirements that are affected by seismic bracing. For example, accommodation of thermal expansion in pressure piping systems often is a critical design consideration, and seismic bracing for these systems must be arranged in a manner that accommodates thermal movements. Particularly in the case of mechanical and electrical systems, the design for seismic loads should not compromise the functionality, durability, or safety of the overall design; this method requires collaboration among the various disciplines of the design and construction team.

For various reasons (e.g., business continuity), it may be desirable to consider higher performance than that required by the building code. For example, to achieve continued operability of a piping system, it is necessary to prevent unintended operation of valves or other in-line components in addition to preventing collapse and providing leak tightness. Higher performance also is required for components containing substantial quantities of hazardous contents (as defined in Section 11.2). These components must be designed to prevent uncontrolled release of those materials.

The requirements of Chapter 13 are intended to apply to nonstructural components in new construction and tenant improvements installed at any time during the life of the structure, provided that they are listed in Table 13.5-1 or 13.6-1. Furthermore, they are intended to reduce (not eliminate) the risk to occupants and to improve the likelihood that essential facilities remain functional. Although property protection (in the

sense of investment preservation) is a possible consequence of implementation of the standard, it is not currently a stated or implied goal; a higher level of protection may be advisable if such protection is desired or required.

C13.1.1 Scope.

The requirements for seismic design of nonstructural components apply to the nonstructural component and to its supports and attachments, regardless of whether it is within or supported by a building or nonbuilding structure, or if it is outside of a structure. Figure 13.1-5 illustrates possible locations of nonstructural components. In some cases, as defined in Section 13.2, it is necessary to consider explicitly the performance characteristics of the component. The requirements are intended to apply only to permanently attached components, not to furniture, temporary items, or mobile units. Furniture, such as tables, chairs, and desks, may shift during strong ground shaking but generally poses minimal hazards provided that it does not obstruct emergency egress routes. Storage cabinets, tall bookshelves, and other items of significant mass do not fall into this category and should be anchored or braced in accordance with this chapter.

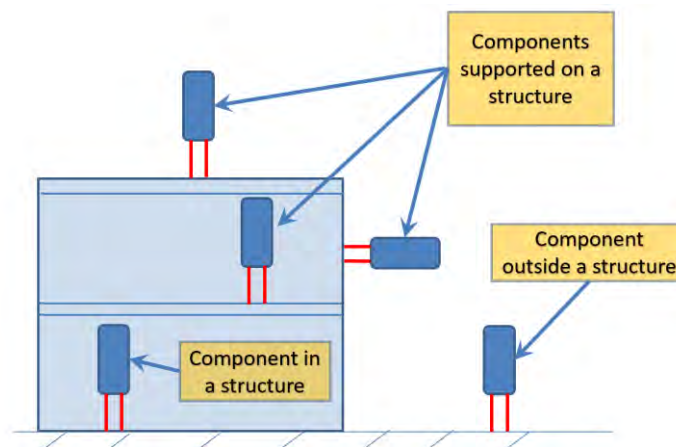

FIGURE 13.1-5 Possible locations of nonstructural components

Temporary items are those that remain in place for short periods of time (months, not years). Components that are expected to remain in place for periods of a year or longer, even if they are designed to be movable, should be considered permanent for the purposes of this section. Modular office systems are considered permanent because they ordinarily remain in place for long periods. In addition, they often include storage units that have significant capacity and may topple in an earthquake. They are subject to the provisions of Section 13.5.8 for partitions if they exceed 6 ft (1.8 m) high. Mobile units include components that are moved from one point in the structure to another during ordinary use. Examples include desktop computers, office equipment, and other components that are not permanently attached to the building utility systems (Figure C13.1-6). Components that are mounted on wheels to facilitate periodic maintenance or cleaning but that otherwise remain in the same location (e.g., server racks) are not considered movable for the purposes of anchorage and bracing. Likewise, skid-mounted components (as shown in Figure C13.1-7), as well as the skids themselves, are considered permanent equipment.



FIGURE C13.1-6 Collapsed Duct and HVAC Diffuser



FIGURE C13.1-7 Skid-Mounted Components

With the exception of solar panels satisfying the provisions of Section 13.6.12, equipment must be anchored if it is permanently attached to utility services (electricity, gas, and water). For the purposes of this requirement, “permanently attached” should be understood to include all electrical connections except NEMA 5-15 and 5-20 straight-blade connectors (duplex receptacles).

C13.1.2 Seismic Design Category.

The requirements for nonstructural components are based in part on the Seismic Design Category (SDC) to which they are assigned. As the SDC is established considering factors not unique to specific nonstructural components, all nonstructural components are assigned to the same SDC as the structure they

are located in or supported by, or to the structure to which they are permanently attached by mechanical or electrical systems.

C13.1.3 Component Importance Factor.

Performance expectations for nonstructural components often are defined in terms of the functional requirements of the structure to which the components are attached. Although specific performance goals for nonstructural components have yet to be defined in building codes, the component Importance Factor (I_p) implies performance levels for specific cases. For noncritical nonstructural components (those with a component Importance Factor, I_p , of 1.0), the following behaviors are anticipated for shaking of different levels of intensity:

1. Minor earthquake ground motions—minimal damage; not likely to affect functionality;
2. Moderate earthquake ground motions—some damage that may affect functionality; and
3. Design earthquake ground motions—major damage but significant falling hazards are avoided; likely loss of functionality.

Components with Importance Factors greater than 1.0 are expected to remain in place, sustain limited damage, and when necessary, function after an earthquake (see Section C13.2.2). These components can be located in structures that are not assigned to Risk Category IV. For example, fire sprinkler piping systems have an Importance Factor, I_p , of 1.5 in all structures because these essential systems should function after an earthquake. Egress stairways are assigned an I_p of 1.5 as well, although in many cases the design of these stairways is dictated by differential displacements, not inertial force demands.

The component Importance Factor is intended to represent the greater of the life-safety importance of the component and the hazard-exposure importance of the structure. It indirectly influences the survivability of the component via required design forces and displacement levels, as well as component attachments and detailing. Although this approach provides some degree of confidence in the seismic performance of a component, it may not be sufficient in all cases. For example, individual ceiling tiles may fall from a ceiling grid that has been designed for larger forces. This problem may not represent a serious falling hazard if the ceiling tiles are made of lightweight materials, but it may lead to blockage of critical egress paths or disruption of the facility function. When higher levels of confidence in performance are required, the component is classified as a designated seismic system (Section 11.2), and in certain cases, seismic qualification of the component or system is necessary. Seismic qualification approaches are provided in Sections 13.2.5 and 13.2.6. In addition, seismic qualification approaches presently in use by the Department of Energy (DOE) can be applied.

Risk Category IV structures are intended to be functional after a design earthquake; critical nonstructural components and equipment in such structures are designed with I_p equal to 1.5. This requirement applies to most components and equipment because damage to vulnerable unbraced systems or equipment may disrupt operations after an earthquake even if they are not directly classified as essential to life safety. The nonessential and nonhazardous components are themselves not affected by this requirement. Instead, requirements focus on the supports and attachments. UFC 3-310-04 (DOD 2007) has additional guidance for improved performance.

C13.1.4 Exemptions.

Several classes of nonstructural components are exempted from the requirements of Chapter 13. The exemptions are made on the assumption that, either because of their inherent strength and stability or the lower level of earthquake demand (accelerations and relative displacements), or both, these nonstructural components and systems can achieve the performance goals described earlier in this commentary without explicitly satisfying the requirements of this chapter.

The requirements are intended to apply only to permanent components, not furniture and temporary or mobile equipment. Furniture (with the exception of more massive elements like storage cabinets) may shift during strong ground shaking but poses minimal hazards. With the exception of solar panels satisfying the provisions of Section 13.6.12, equipment must be anchored if it is permanently attached to the structure utility services, such as electricity, gas, or water. For the purposes of this requirement, “permanently attached” includes all electrical connections except plugs for duplex receptacles.

Temporary items are those that remain in place for six months or less. Modular office systems are considered permanent since they ordinarily remain in place for long periods. In addition, they often include storage units of significant capacity, which may topple in earthquakes. Mobile units include components that are moved from one point in the structure to another during ordinary use. Examples include desktop computers, office equipment, and other components that are not permanently attached to the building utility systems. Components mounted on wheels to facilitate periodic maintenance or cleaning but that otherwise remain in the same location are not considered movable for the purposes of anchorage and bracing.

Furniture resting on floors, such as tables, chairs, and desks, may shift during strong ground shaking, but they generally pose minimal hazards, provided that they do not obstruct emergency egress routes. Examples also include desktop computers, office equipment, and other components that are not permanently attached to the building utility systems.

With the exception of parapets supported by bearing walls or shear walls, all components in Seismic Design Categories A and B are exempt because of the low levels of ground shaking expected. Parapets are not exempt because experience has shown that these items can fail and pose a significant falling hazard, even at low-level shaking levels.

Discrete components are generally understood to be stand-alone items such as cabinets, pumps, electrical boxes, lighting, and signage. Discrete components, architectural or mechanical, weighing 20 lb (89 N) or less generally do not pose a risk and are exempted provided that they are positively attached to the structure, regardless of whether they carry an Importance Factor, I_p , of 1.5 or not. Larger items up to 400 lb (1,780 N) in weight with $I_p = 1.0$ have historically been exempted provided that they are positively attached and have flexible connections. The exemption for mechanical and electrical components in Seismic Design Categories D, E, or F based on weight and location of the center of mass is particularly applicable to vertical equipment racks and similar components. Where detailed information regarding the center of mass of the intended installation is unavailable, a conservative estimate based on potential equipment configurations should be used. The exemption for components weighing 400 lb (1,780 N) or less has existed in provisions for nonstructural components for many years and corresponds roughly to the weight of a 40-gal. (150-L) hot water tank. Coupled with this and the other exemptions in SDC D, E, and F is a requirement that the component be positively attached to the structure. Positive attachment is provided when the attachment is carried out using appropriate structural-grade materials whereby explicit design calculations for the anchorage are not required.

Although the exemptions listed in Section 13.1.4 are intended to waive bracing requirements for nonstructural components that are judged to pose negligible life-safety hazard, in some cases it may nevertheless be advisable to consider bracing (in consultation with the owner) for exempted components to minimize repair costs and/or disproportionate loss (e.g., art works of high value).

The bracing exemptions for short hangers have been moved to the respective sections in which they apply. These exemptions are based on the assumption that the hangers have sufficient ductility to undergo plastic deformations without failure while at the same time providing sufficient stiffness to limit lateral displacement to a reasonable level. This assumption extends to the anchors, and as such the design and detailing of the connections to the structure should take this into account. Raceways, ducts, and piping systems must be able to accommodate the relative displacement demands calculated in Section 13.3.2, since

these displacements can be substantially greater than those that occur at connections to equipment. At seismic separation joints between structures, large displacements may occur over a short distance.

Short hangers fabricated from threaded rods resist lateral force primarily through bending and are prone to failure through cyclic fatigue. Tests conducted by Soulages and Weir (2011) suggest that low cycle fatigue is not an issue when the ductility ratios for the rods are less than about 4. The testing also indicated that swivel connections are not required, provided that the load and rod length limitations are observed. The limits on unbraced trapezes and hangers are based on limiting the ductility ratios to reasonable levels, when subject to the maximum force demands in the highest seismic risk regions. It should be noted that in areas of lower seismic risk, less restrictive criteria could be used.

The exemption for short hangers is limited to the case where every hanger in the raceway run is less than 12 in. (305 mm) because of the need to carefully consider the seismic loads and compatible displacement limits for the portions of raceways with longer hanger supports.

The historical exemption for trapeze-supported conduit less than 2.5 in. (64 mm) trade size has been removed, since its application to specific cases, such as a trapeze supporting multiple conduit runs, was unclear.

The exemption for trapezes with short rod hangers applies only to trapezes configured with the rod hangers attached directly to the trapeze and the structural framing. Where one or more rod hangers for a trapeze are supported from another trapeze, the bracing exemption does not apply.

C13.1.5 Premanufactured Modular Mechanical and Electrical Systems.

Large premanufactured modular mechanical and electrical systems (as shown in Figure C13.1-7) should be considered nonbuilding structures for the purposes of the enveloping structural system design, unless the module has been prequalified in accordance with Section 13.2.2. However, where the premanufactured module has not been prequalified, the nonstructural components contained within the module should be addressed through the requirements of Chapter 13. Note that this provision is not intended to address skid-mounted equipment assemblies not equipped with an enclosure, nor does it address single large components, such as air handlers, cooling towers, chillers, and boilers.



FIGURE C13.1-8 Premanufactured Modular Mechanical Systems

Source: Courtesy of Matthew Tobolski.

C13.1.6 Application of Nonstructural Component Requirements to Nonbuilding Structures.

At times, a nonstructural component should be treated as a nonbuilding structure. When the physical characteristics associated with a given class of nonstructural components vary widely, judgment is needed to select the appropriate design procedure and coefficients. For example, cooling towers vary from small packaged units with an operating weight of 2,000 lb (8.9 kN) or less to structures the size of buildings.

Consequently, design coefficients for the design of “cooling towers” are found both in Tables 13.6-1 and 15.4-2. Small cooling towers are best designed as nonstructural components using the provisions of Chapter 13, whereas large ones are clearly nonbuilding structures that are more appropriately designed using the provisions of Chapter 15. Similar issues arise for other classes of nonstructural component (e.g., boilers and bins). Guidance on determining whether an item should be treated as a nonbuilding structure or nonstructural component for the purpose of seismic design is provided in Bachman and Dowty (2008).

The specified weight limit for nonstructural components (20% relative to the combined weight of the structure and component) relates to the condition at which dynamic interaction between the component and the supporting structural system is potentially significant. Section 15.3.2 contains requirements for addressing this interaction in design.

C13.1.7 Reference Documents.

Professional and trade organizations have developed nationally recognized codes and standards for the design and construction of specific mechanical and electrical components. These documents provide design guidance for normal and upset (abnormal) operating conditions and for various environmental conditions. Some of these documents include earthquake design requirements in the context of the overall mechanical or electrical design. It is the intent of the standard that seismic requirements in referenced documents be used. The developers of these documents are familiar with the expected performance and failure modes of the components; however, the documents may be based on design considerations not immediately obvious to a structural design professional. For example, in the design of industrial piping, stresses caused by seismic inertia forces typically are not added to those caused by thermal expansion.

Where reference documents have been adopted specifically by this standard as meeting the force and displacement requirements of this chapter with or without modification, they are considered to be a part of the standard.

There is a potential for misunderstanding and misapplication of reference documents for the design of mechanical and electrical systems. A registered design professional familiar with both the standard and the reference documents used should be involved in the review and acceptance of the seismic design.

Even when reference documents for nonstructural components lack specific earthquake design requirements, mechanical and electrical equipment constructed in accordance with industry-standard reference documents have performed well historically when properly anchored. Nevertheless, manufacturers of mechanical and electrical equipment are expected to consider seismic loads in the design of the equipment itself, even when such consideration is not explicitly required by this chapter.

Although some reference documents provide requirements for seismic capacity appropriate to the component being designed, the seismic demands used in design may not be less than those specified in the standard.

Specific guidance for selected mechanical and electrical components and conditions is provided in Section 13.6.

Unless exempted in Section 13.1.4, components should be anchored to the structure and, to promote coordination, required supports and attachments should be detailed in the construction documents. Reference documents may contain explicit instruction for anchorage of nonstructural components. The anchorage requirements of Section 13.4 must be satisfied in all cases, however, to ensure a consistent level of robustness in the attachments to the structure.

C13.1.8 Reference Documents Using Allowable Stress Design.

Many nonstructural components are designed using specifically developed reference documents that are based on allowable stress loads and load combinations and generally permit increases in allowable stresses for seismic loading. Although Section 2.4.1 of the standard does not permit increases in allowable stresses,

Section 13.1.8 explicitly defines the conditions for stress increases in the design of nonstructural components where reference documents provide a basis for earthquake-resistant design.

C13.2 GENERAL DESIGN REQUIREMENTS

C13.2.1 Applicable Requirements for Architectural, Mechanical, and Electrical Components, Supports, and Attachments.

Compliance with the requirements of Chapter 13 may be accomplished by project-specific design or by a manufacturer's certification of seismic qualification of a system or component. When compliance is by manufacturer's certification, the items must be installed in accordance with the manufacturer's requirements. Evidence of compliance may be provided in the form of a signed statement from a representative of the manufacturer or from the registered design professional indicating that the component or system is seismically qualified. One or more of the following options for evidence of compliance may be applicable:

1. An analysis (e.g., of a distributed system such as piping) that includes derivation of the forces used for the design of the system, the derivation of displacements and reactions, and the design of the supports and anchorages;
2. A test report, including the testing configuration and boundary conditions used (where testing is intended to address a class of components, the range of items covered by the testing performed should also include the justification of similarities of the items that make this certification valid); and/or
3. An experience data report.

Components addressed by the standard include individual simple units and assemblies of simple units for which reference documents establish seismic analysis or qualification requirements. Also addressed by the standard are complex architectural, mechanical, and electrical systems for which reference documents either do not exist or exist for only elements of the system. In the design and analysis of both simple components and complex systems, the concepts of flexibility and ruggedness often can assist the designer in determining the necessity for analysis and, when analysis is necessary, the extent and methods by which seismic adequacy may be determined. These concepts are discussed in Section C13.6.1.

C13.2.2 Special Certification Requirements for Designated Seismic Systems.

This section addresses the qualification of active designated seismic equipment, its supports, and attachments with the goals of improving survivability and achieving a high level of confidence that a facility will be functional after a design earthquake. Where components are interconnected, the qualification should provide the permissible forces (e.g., nozzle loads) and, as applicable, anticipated displacements of the component at the connection points to facilitate assessment for consequential damage, in accordance with Section 13.2.3. Active equipment has parts that rotate, move mechanically, or are energized during operation. Active designated seismic equipment constitutes a limited subset of designated seismic systems. Failure of active designated seismic equipment itself may pose a significant hazard. For active designated seismic equipment, failure of structural integrity and loss of function are to be avoided.

Examples of active designated seismic equipment include mechanical (components of HVACR systems and piping systems) or electrical (power supply distribution) equipment, medical equipment, fire pump equipment, and uninterruptible power supplies for hospitals. It is generally understood that fire protection sprinkler piping systems designed and installed per NFPA 13 are deemed to comply with the special certification requirements of Section 13.2.2. See Section 13.6.7.2.

There are practical limits on the size of a component that can be qualified via shake table testing. Components too large to be qualified by shake table testing need to be qualified by a combination of structural analysis and qualification testing or empirical evaluation through a subsystem approach.

Subsystems of large, complex components (e.g., large chillers, skid-mounted equipment assemblies, and boilers) can be qualified individually, and the overall structural frame of the component can be evaluated by structural analysis.

Evaluating postearthquake operational performance for active equipment by analysis generally involves sophisticated modeling with experimental validation and may not be reliable. Therefore, the use of analysis alone for active or energized components is not permitted unless a comparison can be made to components that have been otherwise deemed as rugged. As an example, a transformer is energized but contains components that can be shown to remain linearly elastic and are inherently rugged. However, switch equipment that contains fragile components is similarly energized but not inherently rugged, and it therefore cannot be certified solely by analysis. For complex components, testing or experience may therefore be the only practical way to ensure that the equipment will be operable after a design earthquake. Past earthquake experience has shown that much active equipment is inherently rugged. Therefore, evaluation of experience data, together with analysis of anchorage, is adequate to demonstrate compliance of active equipment such as pumps, compressors, and electric motors. In other cases, such as for motor control centers and switching equipment, shake table testing may be required.

With some exceptions (e.g., elevator motors), experience indicates that active mechanical and electrical components that contains electric motors of greater than 10 hp (7.4 kW) or that have a thermal exchange capacity greater than 200 MBH are unlikely to merit the exemption from shake table testing on the basis of inherent ruggedness. Components with lesser motor horsepower and thermal exchange capacity are generally considered to be small active components and are deemed rugged. Exceptions to this rule may be appropriate for specific cases, such as elevator motors that have higher horsepower but have been shown by experience to be rugged. Analysis is still required to ensure the structural integrity of the nonactive components. For example, a 15-ton condenser would require analysis of the load path between the condenser fan and the coil to the building structure attachment.

Where certification is accomplished by analysis, the type and sophistication of the required analysis varies by specific equipment type and construction. Static analysis using the total force specified in Section 13.3 considering applicable load combinations may be appropriate for single components where the structural frame is the only item to be certified and where internal dynamic effects are shown to be negligible. For single components where dynamic effects may be significant, or for assemblages of components, dynamic analysis is strongly suggested. Either modal analysis or response history procedures may be used, but care should be exercised when using modal analysis to ensure that the significant interactions between individual components are properly captured. In all analyses, it is essential that the stiffness, mass, and applied load be distributed in accordance with the component properties, and in sufficient detail (number of degrees of freedom) to allow for the desired forces, deformations, and accelerations to be accurately determined. Input motions for dynamic procedures should reflect the expected motion at the attachment points of the component. Nonlinear behavior of the component is typically not advisable in the certification analysis in the absence of well-documented test results for specific components. Generally, the input motion is (a) a generic floor response spectrum such as that provided in the ICC-ES AC 156, (b) location- and structure-specific floor spectra generated using the procedures of Section 13.3.1, or (c) acceleration time histories developed using dynamic analysis procedures similar to those specified in Chapter 16 or Section 12.9. Horizontal and vertical inputs are usually applied simultaneously when performing these types of dynamic analyses. As with all structural analysis, judgment is required to ensure that the results are applicable and representative of the behavior anticipated for the input motions.

C13.2.3 Consequential Damage.

Although the components identified in Tables 13.5-1 and 13.6-1 are listed separately, significant interrelationships exist and must be considered. Consequential damage occurs because of interaction between components and systems. Even “braced” components displace, and the displacement between lateral supports can be significant in the case of distributed systems such as piping systems, cable and

conduit systems, and other linear systems. It is the intent of the standard that the seismic displacements considered include both relative displacement between multiple points of support (addressed in Section 13.3.2) and, for mechanical and electrical components, displacement within the component assemblies. Impact of components must be avoided, unless the components are fabricated of ductile materials that have been shown to be capable of accommodating the expected impact loads. With protective coverings, ductile mechanical and electrical components and many more fragile components are expected to survive all but the most severe impact loads. Flexibility and ductility of the connections between distribution systems and the equipment to which they attach is essential to the seismic performance of the system.

The determination of the displacements that generate these interactions is not addressed explicitly in Section 13.3.2.1. That section concerns relative displacement of support points. Consequential damage may occur because of displacement of components and systems between support points. For example, in older suspended ceiling installations, excessive lateral displacement of a ceiling system may fracture sprinkler heads that project through the ceiling. A similar situation may arise if sprinkler heads projecting from a small-diameter branch line pass through a rigid ceiling system. Although the branch line may be properly restrained, it may still displace sufficiently between lateral support points to affect other components or systems. Similar interactions occur where a relatively flexible distributed system connects to a braced or rigid component.

The potential for impact between components that are in contact with or close to other structural or nonstructural components must be considered. However, where considering these potential interactions, the designer must determine if the potential interaction is both credible and significant. For example, the fall of a ceiling panel located above a motor control center is a credible interaction because the falling panel in older suspended ceiling installations can reach and impact the motor control center. An interaction is significant if it can result in damage to the target. Impact of a ceiling panel on a motor control center may not be significant because of the light weight of the ceiling panel. Special design consideration is appropriate where the failure of a nonstructural element could adversely influence the performance of an adjacent critical nonstructural component, such as an emergency generator.

C13.2.4 Flexibility.

In many cases, flexibility is more important than strength in the performance of distributed systems, such as piping and ductwork. A good understanding of the displacement demand on the system, as well as its displacement capacity, is required. Components or their supports and attachments must be flexible enough to accommodate the full range of expected differential movements; some localized inelasticity is permitted in accommodating the movements. Relative movements in all directions must be considered. For example, even a braced branch line of a piping system may displace, so it needs to be connected to other braced or rigid components in a manner that accommodates the displacements without failure (Figure C13.2-1). A further example is provided by cladding units (such as precast concrete wall units). Often very rigid in plane, cladding units require connections capable of accommodating story drift if attached at more than one level. (See Figure C13.3-4 for an illustration.)

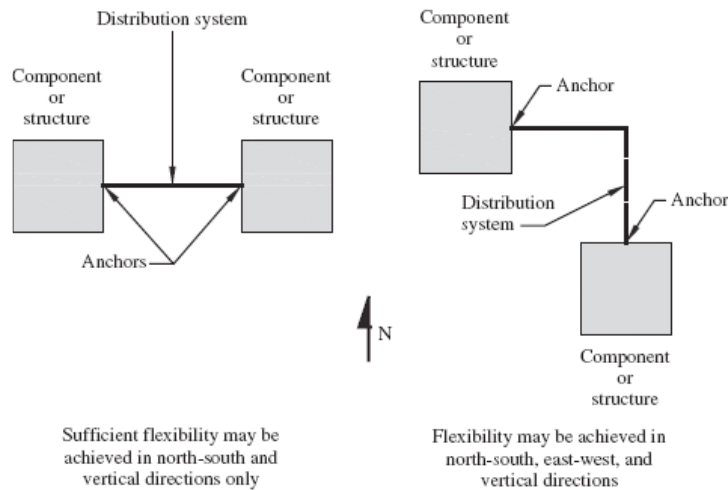

FIGURE C13.2-1 Schematic Plans Illustrating Branch Line Flexibility

If component analysis assumes rigid anchors or supports, the predicted loads and local stresses can be unrealistically large, so it may be necessary to consider anchor and/or support stiffness.

C13.2.5 Testing Alternative for Seismic Capacity Determination.

Testing is a well-established alternative method of seismic qualification for small- to medium-size equipment. Several national reference documents have testing requirements adaptable for seismic qualification. One such reference document (ICC-ES AC 156) is a shake table testing protocol that has been adopted by the International Code Council Evaluation Service. It was developed specifically to be consistent with acceleration demands (that is, force requirements) of the standard.

The development or selection of testing and qualification protocols should at a minimum include the following:

1. Description of how the protocol meets the intent for the project-specific requirements and relevant interpretations of the standard;
2. Definition of a test input motion with a response spectrum that meets or exceeds the design earthquake spectrum for the site;
3. Accounting for dynamic amplification caused by above-grade equipment installations (consideration of the actual dynamic characteristics of the primary support structure is permitted, but not required);
4. Definition of how shake table input demands were derived;
5. Definition and establishment of a verifiable pass/fail acceptance criterion for the seismic qualification based on the equipment Importance Factor and consistent with the building code and project-specific design intent; and
6. Development of criteria that can be used to rationalize test unit configuration requirements for highly variable equipment product lines.

To aid the design professional in assessing the adequacy of the manufacturer's certificate of compliance, it is recommended that certificates of compliance include the following:

1. Product family or group covered;
2. Building code(s) and standard(s) for which compliance was evaluated;
3. Testing standard used;

4. Performance objective and corresponding Importance Factor ($I_p = 1.0$ or $I_p = 1.5$);
5. Seismic demand for which the component is certified, including code and/or standard design parameters used to calculate seismic demand (such as values used for C_{AR} , R_{po} , R_{μ} , H_f , and site class); and
6. Installation restrictions, if any (grade, floor, or roof level).

Without a test protocol recognized by the building code, qualification testing is inconsistent and difficult to verify. The use of ICC-ES AC 156 simplifies the task of compliance verification because it was developed to address directly the testing alternative for nonstructural components, as specified in the standard. It also sets forth minimum test plan and report deliverables.

Use of other standards or ad hoc protocols to verify compliance of nonstructural components with the requirement of the standard should be considered carefully and used only where project-specific requirements cannot be met otherwise.

Where other qualification test standards are used, in whole or in part, it is necessary to verify compliance with this standard. For example, IEEE 693 (2005) indicates that it is to be used for the sole purpose of qualifying electrical equipment (specifically listed in the standard) for use in utility substations. Where equipment testing has been conducted to other standards (for instance, testing done in compliance with IEEE 693), a straightforward approach would be to permit evaluation, by the manufacturer, of the test plan and data to validate compliance with the requirements of ICC-ES AC 156 because it was developed specifically to comply with the seismic demands of this standard.

The qualification of mechanical and electrical components for seismic loads alone may not be sufficient to achieve high-performance objectives. Establishing a high confidence that performance goals will be met requires consideration of the performance of structures, systems (e.g., fluid, mechanical, electrical, and instrumentation), and their interactions (e.g., interaction of seismic and other loads), as well as compliance with installation requirements.

C13.2.6 Experience Data Alternative for Seismic Capacity Determination.

An established method of seismic qualification for certain types of nonstructural components is the assessment of data for the performance of similar components in past earthquakes. The seismic capacity of the component in question is extrapolated based on estimates of the demands (e.g., force or displacement) to which the components in the database were subjected. Procedures for such qualification have been developed for use in nuclear facility applications by the Seismic Qualification Utility Group (SQUG) of the Electric Power Research Institute.

The SQUG rules for implementing the use of experience data are described in a proprietary Generic Implementation Procedure database. It is a collection of findings from detailed engineering studies by experts for equipment from a variety of utility and industrial facilities.

Valid use of experience data requires satisfaction of rules that address physical characteristics; manufacturer's classification and standards; and findings from testing, analysis, and expert consensus opinion.

Four criteria are used to establish seismic qualification by experience, as follows:

1. Seismic capacity versus demand (a comparison with a bounding spectrum);
2. Earthquake experience database cautions and inclusion rules;
3. Evaluation of anchorage; and
4. Evaluation of seismic interaction.

Experience data should be used with care because the design and manufacture of components may have changed considerably in the intervening years. The use of this procedure is also limited by the relative rarity of strong-motion instrument records associated with corresponding equipment experience data.

C13.2.7 Construction Documents.

Where the standard requires seismic design of components or their supports and attachments, appropriate construction documents defining the required construction and installation must be prepared. These documents facilitate the special inspection and testing needed to provide a reasonable level of quality assurance. Of particular concern are large nonstructural components (such as rooftop chillers) whose manufacture and installation involve multiple trades and suppliers and which impose significant loads on the supporting structure. In these cases, it is important that the construction documents used by the various trades and suppliers be prepared by a registered design professional to satisfy the seismic design requirements.

The information required to prepare construction documents for component installation includes the dimensions of the component, the locations of attachment points, the operating weight, and the location of the center of mass. For instance, if an anchorage angle is attached to the side of a metal chassis, the gauge and material of the chassis must be known so that the number and size of required fasteners can be determined. Or when a piece of equipment has a base plate that is anchored to a concrete slab with expansion anchors, the drawings must show the base plate's material and thickness, the diameter of the bolt holes in the plate, and the size and depth of embedment of the anchor bolts. If the plate is elevated above the slab for leveling, the construction documents must also show the maximum gap permitted between the plate and the slab.

C13.2.8 Supported Nonstructural Components with Greater Than or Equal to 20% Combined Weight.

See Sections C15.3.1 and C15.3.2.

C13.3 SEISMIC DEMANDS ON NONSTRUCTURAL COMPONENTS

The seismic demands on nonstructural components, as defined in this section, are acceleration demands and relative displacement demands. Acceleration demands are represented by equivalent static forces. Relative displacement demands are provided directly and are based on either the actual displacements computed for the structure or the maximum allowable drifts that are permitted for the structure.

C13.3.1 Seismic Design Force.

The seismic design force for a component depends on the weight of the component, the component Importance Factor, ground shaking intensity, seismic force-resisting system and dynamic properties of the supporting structure, vertical location of the component within the supporting structure, and the dynamic properties, strength, and ductility of the nonstructural component. The forces prescribed in this section of the standard reflect the dynamic and structural characteristics of nonstructural components. As a result of these characteristics, forces used for verification of component integrity and design of connections to the supporting structure typically are larger than those used for design of the overall seismic force-resisting system.

Certain nonstructural components lack the desirable attributes of structures (such as ductility, toughness, and redundancy) that permit the use of greatly reduced lateral design forces. Thus, the design lateral forces for nonstructural components as percentage of weight are generally larger than values for structures. These various design coefficients used to represent the expected response of nonstructural components that are tabulated in Tables 13.5-1 and 13.6-1 are based on the collective judgment of the responsible committee.

With this edition of the NEHRP Provisions, significant revisions are made to the nonstructural seismic design force equations. They are based on the proposed equations and underlying research in the Applied Technology Council ATC-120 project that resulted in NIST GCR 18-917-43 *Recommendations for Improved Seismic Performance of Nonstructural Components* (NIST, 2018). The goal of that effort was to

develop equations that have a more rigorous scientific basis and capture the key parameters that can affect nonstructural component response and yet remain appropriate for use in design by practicing engineers.

The ATC-120 project reviewed the available literature, identified key parameters of interest, assessed the influence of these parameters individually on component response, focused on parameters shown to strongly affect response, and then tested a set of equations combining all the selected parameters of interest using an extensive set of nonlinear analyses of archetype buildings and components as well as analysis of strong motion records from instrumented buildings. Chapter 4 and Appendices B and C of NIST (2018) summarize the literature review, analysis approach and findings, and proposed equation. General comparisons are made between the proposed equation and results from ASCE/SEI 7-16, and a set of more specific case study examples are provided.

Key Features

The parameters that were investigated include ground shaking intensity, seismic force-resisting system of the building, building modal period, building ductility, inherent building damping, building configuration, floor diaphragm rigidity, vertical location of the component within the building, component period, component and/or anchorage ductility, inherent component damping, and component overstrength. Parameters selected for inclusion in the final set of equations include all of the above except inherent building damping, building configuration, and floor diaphragm rigidity.

Using the above selected parameters, the proposed equations in NIST (2018) and in Section 13.3.1 include a set of key features. These include:

- Ratio of Peak Floor Acceleration (PFA) to Peak Ground Acceleration (PGA): Based on a detailed review of instrumented building strong motion records, a more refined equation was developed to relate PFA to PGA at different heights in the building. The equation incorporates building period. This is accounted for in the variable H_f of Eq. (13.3-1).
- Building ductility: Increased building ductility has been shown to generally reduce nonstructural component response. This is captured by the variable R_u . The equation for determining R_u is based on a series of archetype case studies using different seismic force-resisting systems, numbers of stories, and overstrength assumptions.
- Ratio of Peak Component Acceleration (PCA) to Peak Floor Acceleration (PFA): The relationship between PCA and PFA, defined as C_{AR} in Eq. (13.3-1), is affected by several parameters including the ratio of component period to building period, and component ductility. When component and building periods are close, component response is increased due to resonance; when component ductility is larger, component response decreases. These effects are captured by two concepts in the proposed equation framework. The first is whether component response is likely or unlikely to be in resonance with the building response. When the ratio of component period to building period is relatively small or relatively large, resonance is unlikely, and C_{AR} is set to 1.0. When the ratio is closer to unity, resonance is likely, and C_{AR} is amplified to account for resonance. The second concept is to create low, moderate, or high component ductility categories for situations with likely resonance. C_{AR} values for low ductility are higher than those for high ductility. The selected C_{AR} values are based on archetype studies and account for some level of reduction from the theoretical peak value to address the probability of overlap between component and building periods. Although quantitative studies to determine the statistical reliability that the equations envelope archetype results were not performed, the number of studies performed was substantial, and engineering judgment was used in parameter studies and final equation setting to target a general design level such that the proposed equations are approximately mean plus one standard deviation above archetype results. Due to the number of parameters involved and their potential for variation, in some cases, there will be a higher level of reliability; in other cases, there will be a lower level of reliability.

- **Component Strength:** Like building structural systems, the component and its attachments to the structure typically have some inherent overstrength. This is captured by the variable R_{po} . It serves to reduce the design force needed.
- **Ground vs. Superstructure:** The amplification of PCA/PFA as the ratio of component to building period approaches unity comes from narrow band filtering of response by the dynamic properties of the building. Components that are ground supported can see dynamic amplification due to component flexibility, based on structural dynamics, but this amplification is typically less than what occurs in the building. Given that there are both theoretical and numerical differences between the ground and superstructure cases, it was decided to distinguish the two.

In the code development process, the following revisions were made from the equations proposed in NIST (2018).

Building Ductility

Determination of the Structure Ductility Reduction Factor, R_u , relies on the R and Ω_o values in Table 12.2-1, Table 15.4-1, and Table 15.4-2. While these variables were not originally intended to be used in the determination of lateral forces on nonstructural components, they provide a reasonable basis for estimating ductility and strength of building lateral force-resisting systems commonly used in SDC D and higher. For nonbuilding structures, the tabulated values of R and Ω_o were assigned on both technical considerations and to facilitate inclusion of low ductility systems into the building codes. In regions of high seismicity, the low values of R that are used, especially for nonbuilding structures not similar to buildings, do not reflect behaviors such as sliding and rocking that reduce floor accelerations in these structures. To reflect this, a lower limit of 1.3 is placed on the value of R_u .

When determining the value of R_u , several alternative situations can arise, including the following.

- If a seismic force-resisting system is not listed in these tables or the seismic force-resisting system does not conform to the associated requirements for the system, then use $R_u = 1.3$. This situation can apply to existing buildings with detailing provisions that do not meet current requirements and have less available ductility.
- If the seismic force-resisting system in which the component will be placed are not known, but it is known that it will be a system that complies with Table 12.2-1, Table 15.4-1, or Table 15.4-2, then use the lowest value of R_u in the applicable table for the applicable Seismic Design Category. This situation can arise when the component anchorage and bracing are designed to be able to be installed in a range of potential code-conforming buildings. It can also apply when the engineer responsible for anchorage and bracing of the component is told it is for a new building, but information about the building's seismic force-resisting system is not provided.
- If an alternative system has been developed with associated R and Ω_o values and approved by the Authority Having Jurisdiction, then use those values to determine R_u .
- If the seismic force-resisting system category is known, but the details are unknown, such as it is known that the system is a braced frame but which type of braced frame system is not known, then use the braced frame system with the lowest value of R_u , which is the steel ordinary concentrically braced frame with $R_u = (1.1R/\Omega_o)^{1/2} = [(1.1)(3.25)/(2.0)]^{1/2} = 1.3$.
- If nonlinear response history analysis is performed, then the procedure in Section 13.1.3.1.5 can be used, and R_u need not be calculated.

Increasing building ductility generally reduces nonstructural component seismic demands, and reduced ductility generally increases component demands. Buildings with higher design forces (such as those using a Seismic Importance Factor $I_e > 1.0$) and/or higher levels of overstrength will have less ductility demand for the same level of seismic shaking than those designed to code minimums and with limited overstrength.

To address this issue, the ATC-120 project analyses included building archetypes with both limited overstrength and with substantial overstrength. Calibration studies were done to reasonably bound results from the archetypes with substantial overstrength.

An alternative procedure for diaphragm design was introduced in ASCE/SEI 7-16. The procedure, presented in Section 12.10.3, considers the strength and ductility of the diaphragm and provides procedures to obtain more realistic diaphragm design forces. The development of that procedure is described in Commentary Section C12.10.3. Both the diaphragm procedures and nonstructural component force equations can produce floor acceleration profiles over the height of the structure. These profiles will differ, due to differences in formulation of the acceleration profiles. The less complex procedures in Chapter 13 produce more conservative estimates of acceleration. The acceleration profile in Eq. (13.3-1) is described by the ratio $\frac{H_f}{R_\mu}$, where H_f is a factor for force amplification determined using the approximate fundamental period T_a , and R_μ is a structure ductility reduction factor determined using R and Ω_0 . The diaphragm design procedure in Chapter 12 is a substantially more complex process and produces lower floor acceleration estimates, due to the use of the period T , which is generally larger than the approximate period T_a , the use of S_{DI} for longer period structures, and due to a more refined method for considering modal effects. That procedure has not been adopted for the determination of floor accelerations used to design nonstructural component and system restraints since the determination of F_p is correlated to the use of the approximate fundamental period T_a . (NIST 2018)

Determination of Likelihood of Being in Resonance

Nonstructural components have been categorized as likely or unlikely to be in resonance by engineering judgment. An underlying concept is that if the component period, T_p , is less than 0.06 seconds, then resonance is unlikely regardless of building period, since the building period will typically be well above that level. In previous editions of the *Provisions* components with $T_p \leq 0.06$ seconds were termed “rigid” and did not receive any amplification of PFA (while those with $T_p > 0.06$ were termed “flexible” and received an increase of 2.5 times PFA). A second underlying concept is that, when the ratio of component period to building period is relatively low or relatively large, then resonance is also unlikely. A criterion of $T_p / T_a < 0.5$ or $T_p / T_a > 1.5$ can be used, as suggested by NIST (2018) as well as extrapolation of results from Hadjian and Ellison (1986). Distribution systems may experience resonance, but its effect is judged to be minimized due to reduced mass participation caused by multiple points of support.

Component Ductility Categories

Nonstructural components have been assigned to one of three categories of component ductility. In the ATC-120 studies, the following underlying relationships were used.

<u>Ductility Category</u>	<u>Assumed Component Ductility, μ_{comp}</u>	<u>PCA/PFA (C_{AR})</u>	
		<u>Supported at or Below Grade</u>	<u>Supported Above Grade by a Structure</u>
<u>Elastic</u>	<u>1</u>	<u>2.5</u>	<u>4.0</u>
<u>Low</u>	<u>1.25</u>	<u>2.0</u>	<u>2.8</u>
<u>Moderate</u>	<u>1.5</u>	<u>1.8</u>	<u>2.2</u>
<u>High</u>	<u>2.0</u>	<u>1.4</u>	<u>1.4</u>

As discussed in NIST (2018), the elastic category is used for reference only. It is assumed that typical nonstructural components and their attachments to the structure systems used in practice have at least the low level of component ductility.

Alternative C_{AR} values can be developed for components that are not in the table or when substantiating data is available. Such data can be derived from instrumented shake table component tests that compare the acceleration experienced by the component (PCA) at its effective center of mass versus the acceleration of the shake table (PFA). Such tests need to include realistic attachments between the component and the anchors and realistic anchorage.

Equipment Support Conditions

Design coefficients are assigned to mechanical and electrical equipment based on the properties of the equipment item, but equipment may be supported on a platform or support structure that has structural properties that are substantially different from the equipment itself. In some cases, this can be beneficial, such as when a moderate or low ductility component is mounted on a platform or support structure with high ductility. In this case, the platform or support structure will limit the shaking demands on supported components, by providing a structure with a ductile behavior in the load path.

Determination of Ground vs. Superstructure Category

Nonstructural components supported by slabs or foundation elements at grade that are not part of a building use the ground category. Similarly, nonstructural components supported by slabs or foundations, or other elements of the superstructure located at or below grade use the ground category. For the definition of grade, including sloping sites, see the definition of “Grade Plane” In Section 11.2.

Design Forces for Elements in the Load Path with Limited Ductility

Anchors in concrete or masonry that cannot develop a ductile yield mechanism are required to use design forces increased by the Ω_{op} factor. Designers should consider amplifying design forces by an overstrength factor for elements in the load path between the component and the anchor that have limited ductility.

C13.3.1.1 Amplification with Height, H_r

The FEMA P-58/BD-3.7.17 report observed that while the approximate fundamental period T_a may underestimate the period of a structure, the fundamental period of the structure T determined in Section 12.8.2 tends to overestimate it. In buildings, the gravity system, partitions, and cladding all act to reduce the fundamental period, which will increase the lateral force on nonstructural components. T_a was recommended by the ATC-120 team to provide a reasonable estimate of the building fundamental period for the purposes of computing forces on nonstructural components. Nonbuilding structures generally lack partitions and cladding, and the gravity system is less extensive than that found in buildings, making the bare frame period of the structure suitable for component lateral force calculations.

C13.3.1.5 Nonlinear Response History Analysis

When nonlinear response history analysis is used to design a structure, there are several options available for calculating the seismic demands on nonstructural components. The forces can be determined using the basic equation, Eq.(13.3-1), or the designer may choose to take advantage of the more sophisticated analysis procedures that were used to design the structure found in Chapters 16, 17, or 18. The minimum number of ground motions used for design of the structure differs depending on which chapter is used. The intent is that the entire suite of motions used to design the structure shall also be used to determine the forces on nonstructural components. In some cases, a structure may be analyzed using the procedures of Chapter 12, but it is desired that the forces on the nonstructural components be determined using nonlinear response history analysis. In such a case, a minimum of 7 motions shall be used.

C13.3.2 Seismic Relative Displacements.

The equations of this section are for use in design of cladding, stairways, windows, piping systems, sprinkler components, and other components connected to one structure at multiple levels or to multiple structures. Two equations are given for each situation. Eqs. (13.3-7) and (13.3-9) produce structural displacements as determined by elastic analysis, unreduced by the structural response modification factor (R). Because the actual displacements may not be known when a component is designed or procured, Eqs. (13.3-8) and (13.3-10) provide upper-bound displacements based on structural drift limits. Use of upper-bound equations may facilitate timely design and procurement of components but may also result in costly added conservatism.

Designers should be aware that some buildings are designed without drift limits; this is permitted in footnote c of Table 12.12-1. Similarly, for buildings designed with drift limits, those limits only apply at the center of mass of the structure (or, in certain cases, at the building perimeter). The drift limit does not apply to the Design Earthquake Displacement, and thus the displacement demand on a component may exceed the drift limit unless the drift limit has been applied to the entire structure. The value of seismic relative displacements is taken as the calculated displacement, D_p , times the Importance Factor, I_e , because the elastic displacement calculated in accordance with Eq. (12.8-15) to establish δ_x (and thus D_p) is adjusted for I_e in keeping with the philosophy of displacement demand for the structure. For component design, the unreduced elastic displacement is appropriate.

The standard does not provide explicit acceptance criteria for the effects of seismic relative displacements, except for glazing. Damage to nonstructural components caused by relative displacement is acceptable, provided that the performance goals defined elsewhere in the chapter are achieved.

The design of some nonstructural components that span vertically in the structure can be complicated when supports for the element do not occur at horizontal diaphragms. The language in Section 13.3.2 was previously amended to clarify that story drift must be accommodated in the elements that actually distort. For example, a glazing system supported by precast concrete spandrels must be designed to accommodate the full story drift, even though the height of the glazing system is only a fraction of the floor-to-floor height. This condition arises because the precast spandrels behave as rigid bodies relative to the glazing system and therefore all the drift must be accommodated by anchorage of the glazing unit, the joint between the precast spandrel and the glazing unit, or some combination of the two.

C13.3.2.1 Displacements within Structures.

Seismic relative displacements can subject components or systems to unacceptable stresses. The potential for interaction resulting from component displacements (in particular for distributed systems) and the resulting impact effects should also be considered (see Section 13.2.3).

These interrelationships may govern the clearance requirements between components or between components and the surrounding structure. Where sufficient clearance cannot be provided, consideration should be given to the ductility and strength of the components and associated supports and attachments to accommodate the potential impact.

Where nonstructural components are supported between, rather than at, structural levels, as frequently occurs for glazing systems, partitions, stairs, veneers, and mechanical and electrical distributed systems, the height over which the displacement demand, D_p , must be accommodated may be less than the story height, h_{sx} , and should be considered carefully. For example, consider the glazing system supported by rigid precast concrete spandrels shown in Figure C13.3-4. The glazing system may be subjected to full story drift, D_p , although its height ($h_x - h_y$) is only a fraction of the story height. The design drift must be accommodated by anchorage of the glazing unit, the joint between the precast spandrel and the glazing unit,

or some combination of the two. Similar displacement demands arise where pipes, ducts, or conduits that are braced to the floor or roof above are connected to the top of a tall, rigid, floor-mounted component.

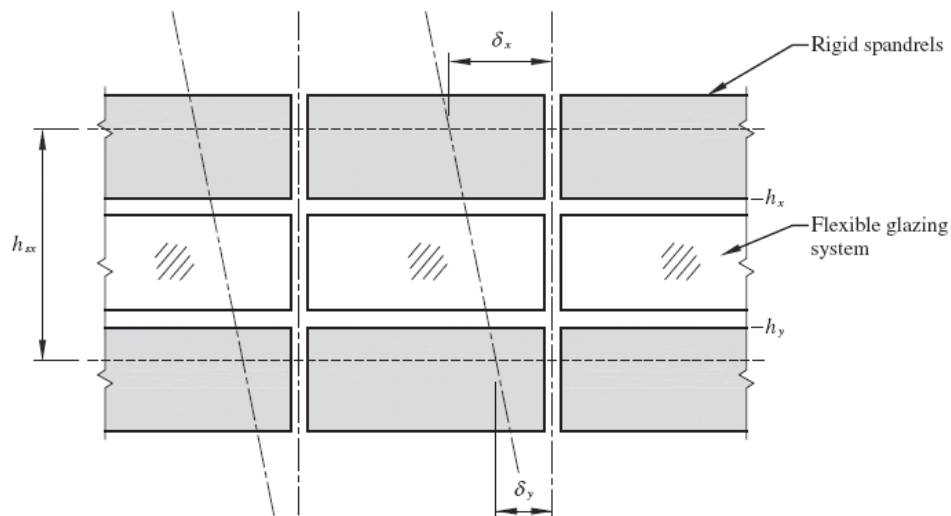

FIGURE C13.3-4 Displacements over Less than Story Height

For ductile components, such as steel piping fabricated with welded connections, the relative seismic displacements between support points can be more significant than inertial forces. Ductile piping can accommodate relative displacements by local yielding with strain accumulations well below failure levels. However, for components fabricated using less ductile materials, where local yielding must be avoided to prevent unacceptable failure consequences, relative displacements must be accommodated by flexible connections.

C13.3.2.2 Displacements between Structures.

A component or system connected to two structures must accommodate horizontal movements in any direction, as illustrated in Figure C13.3-5.

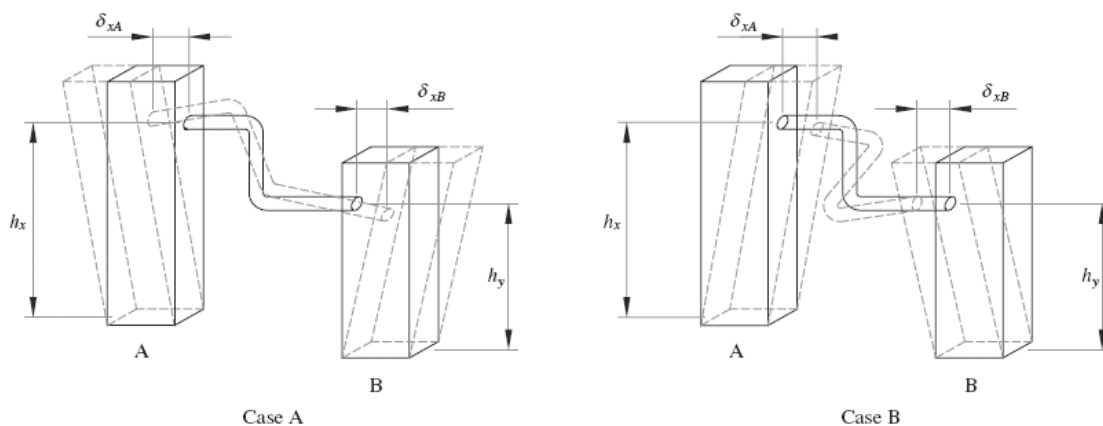

FIGURE C13.3-5 Displacements between Structures

C13.3.3 Component Period.

Component period is used to classify components as rigid ($T \leq 0.06$ s) or flexible ($T > 0.06$ s). Determination of the fundamental period of an architectural, mechanical, or electrical component using analytical or test methods is often difficult and, if not properly performed, may yield incorrect results. In the case of mechanical and electrical equipment, the flexibility of component supports and attachments typically dominates component response and fundamental component period, and analytical determinations of component period should consider those sources of flexibility. Where testing is used, the dominant mode of vibration of concern for seismic evaluation must be excited and captured by the test setup. The dominant mode of vibration for these types of components cannot generally be acquired through in situ tests that measure only ambient vibrations. To excite the mode of vibration with the highest fundamental period by in situ testing, relatively significant input levels of motion may be required to activate the flexibility of the base and attachment. A resonant frequency search procedure, such as that given in ICC-ES acceptance criteria (AC156 2010), may be used to identify the dominant modes of vibration of a component.

Many mechanical components have fundamental periods below 0.06 s and may be considered rigid. Examples include horizontal pumps, engine generators, motor generators, air compressors, and motor-driven centrifugal blowers. Other types of mechanical equipment, while relatively stiff, have fundamental periods (up to about 0.13 s) that do not permit automatic classification as rigid. Examples include belt-driven and vane axial fans, heaters, air handlers, chillers, boilers, heat exchangers, filters, and evaporators. Where such equipment is mounted on vibration isolators, the fundamental period is substantially increased.

Electrical equipment cabinets can have fundamental periods ranging from 0.06 to 0.3 s, depending upon the supported weight and its distribution, the stiffness of the enclosure assembly, the flexibility of the enclosure base, and the load path through to the attachment points. Tall, narrow motor control centers and switchboards lie at the upper end of this period range. Low- and medium-voltage switchgear, transformers, battery chargers, inverters, instrumentation cabinets, and instrumentation racks usually have fundamental periods ranging from 0.1 to 0.2 s. Braced battery racks, stiffened vertical control panels, bench boards, electrical cabinets with top bracing, and wall-mounted panelboards generally have fundamental periods ranging from 0.06 to 0.1 s.

C13.4 NONSTRUCTURAL COMPONENT ANCHORAGE

Unless exempted in Section 13.1.4 or 13.6.9, components must be anchored to the structure, and all required supports and attachments must be detailed in the construction documents. To satisfy the load path requirement of this section, the detailed information described in Section C13.2.7 must be communicated during the design phase to the registered design professional responsible for the design of the supporting structure. The load path includes housekeeping slabs and curbs, which must be adequately reinforced and positively fastened to the supporting structure. Because the exact magnitude and location of the loads imposed on the structure may not be known until nonstructural components are ordered, the initial design of supporting structural elements should be based on conservative assumptions. The design of the supporting structural elements must be verified once the final magnitude and location of the design loads have been established. The limited exception for ballasted rooftop solar panels meeting the requirements of Section 13.6.12 is intended to accommodate the increasing use of such arrays on roof systems where positive attachment is difficult.

Design documents should provide details with sufficient information so that compliance with these provisions can be verified. Parameters such as I_p , S_{DS} , R_μ , R_{po} , C_{AR} , and W_p should be noted. Attachment details may include, as appropriate, dimensions and material properties of the connecting material, weld sizes, bolt sizes and material types for steel-to-steel connections, postinstalled anchor types, diameters, embedments, installation requirements, sheet metal screw diameters and material thicknesses of

the connected parts, wood fastener types, and minimum requirements for specific gravity of the base materials.

Seismic design forces are determined using the provisions of Section 13.3.1. Specific reference standards should be consulted for additional adjustments to loads or strengths. Refer, for example, to the anchor design provisions of ACI 318, Chapter 17, for specific provisions related to seismic design of anchors in concrete. Unanchored components often rock or slide when subjected to earthquake motions. Because this behavior may have serious consequences, is difficult to predict, and is exacerbated by vertical ground motions, positive restraint must be provided for each component.

The effective seismic weight used in design of the seismic force-resisting system must include the weight of supported components. To satisfy the load path requirements of this section, localized component demand must also be considered. This satisfaction may be accomplished by checking the capacity of the first structural element in the load path (for example, a floor beam directly under a component) for combined dead, live, operating, and seismic loads, using the horizontal and vertical loads from Section 13.3.1 for the seismic demand, and repeating this procedure for each structural element or connection in the load path until the load case, including horizontal and vertical loads from Section 13.3.1, no longer governs design of the element. The load path includes housekeeping slabs and curbs, which must be adequately reinforced and positively fastened to the supporting structure.

Because the exact magnitude and location of loads imposed on the structure may not be known until nonstructural components are ordered, the initial design of supporting structural elements should be based on conservative assumptions. The design of the supporting structural elements may need to be verified once the final magnitude and location of the design loads have been established.

Tests have shown that there are consistent shear ductility variations between bolts installed in drilled or punched plates with nuts and connections using welded shear studs. The need for reductions in allowable loads for particular anchor types to account for loss of stiffness and strength may be determined through appropriate dynamic testing. Although comprehensive design recommendations are not available at present, this issue should be considered for critical connections subject to dynamic or seismic loading.

C13.4.1 Design Force in the Attachment.

Previous editions of ASCE/SEI 7 included provisions for the amplification of forces to design the component anchorage, or limits of the values of response modification factors. These provisions were intended to ensure that the anchorage either (a) would respond to overload in a ductile manner or (b) would be designed so that the anchorage would not be the weakest link in the load path. While amplified forces for design of component anchorage currently focus on anchors to concrete and masonry, any component anchorage subject to a brittle failure mechanism where a loss of component stability could result should be designed to avoid such an anchorage failure.

The revisions to the force equations produce more accurate estimates of seismic demands on nonstructural components and the component resonance ductility factors (C_{AR}) for high ductility components are all the same, eliminating the need for a cap on some components.

C13.4.2 Anchors in Concrete or Masonry.

Design capacity for anchors in concrete must be determined in accordance with ACI 318, Chapter 17. Design capacity for anchors in masonry is determined in accordance with TMS 402. Anchors must be designed to have ductile behavior or to provide a specified degree of excess strength. Depending on the specifics of the design condition, ductile design of anchors in concrete may satisfy one or more of the following objectives:

1. Adequate load redistribution between anchors in a group;
2. Allowance for anchor overload without brittle failure; or

3. Energy dissipation.

Achieving deformable, energy-absorbing behavior in the anchor itself is often difficult. Unless the design specifically addresses the conditions influencing desirable hysteretic response (e.g., adequate gauge length, anchor spacing, edge distance, and steel properties), anchors cannot be relied on for energy dissipation. Simple geometric rules, such as restrictions on the ratio of anchor embedment length to depth, may not be adequate to produce reliable ductile behavior. For example, a single anchor with sufficient embedment to force ductile tension failure in the steel body of the anchor bolt may still experience concrete fracture (a nonductile failure mode) if the edge distance is small, the anchor is placed in a group of tension-loaded anchors with reduced spacing, or the anchor is loaded in shear instead of tension. In the common case where anchors are subject primarily to shear, response governed by the steel element may be nonductile if the deformation of the anchor is constrained by rigid elements on either side of the joint. Designing the attachment so that its response is governed by a deformable link in the load path to the anchor is encouraged. This approach provides ductility and overstrength in the connection while protecting the anchor from overload. Ductile bolts should only be relied on as the primary ductile mechanism of a system if the bolts are designed to have adequate gauge length (using the unbonded strained length of the bolt) to accommodate the anticipated nonlinear displacements of the system at the design earthquake. Guidance for determining the gauge length can be found in Part 3 of the 2009 NEHRP Provisions.

The revised force equations allow correlation between the component resonance ductility factor, C_{AR} , and the anchorage overstrength factor Ω_{op} . In general, components unlikely to be in resonance and high ductility components likely to be in resonance are assigned the highest anchorage overstrength factor. These components are designed for lower lateral forces, and an extra margin of strength in anchorage to concrete and masonry is warranted in the event that some resonance does occur or the component ductility is lower than anticipated. Low ductility components that are likely to be in resonance are designed for high lateral force levels. Since minimal reductions in response due to ductile behavior are expected, the design lateral force is less likely to be exceeded in a design earthquake warranting a lower anchorage overstrength factor.

Anchors used to support towers, masts, and equipment are often provided with double nuts for leveling during installation. Where base-plate grout is specified at anchors with double nuts, it should not be relied on to carry loads because it can shrink and crack or be omitted altogether. The design should include the corresponding tension, compression, shear, and flexure loads.

Postinstalled anchors in concrete and masonry should be qualified for seismic loading through appropriate testing. The requisite tests for expansion and undercut anchors in concrete are given in ACI 355.2-07, *Qualification of Post-Installed Mechanical Anchors in Concrete and Commentary* (2007). Testing and assessment procedures based on the ACI standard that address expansion, undercut, screw, and adhesive anchors are incorporated in ICC-ES acceptance criteria. AC193, *Acceptance Criteria for Mechanical Anchors in Concrete Elements* (2012c), and AC308, *Acceptance Criteria for Post-Installed Adhesive Anchors in Concrete Elements* (2012d), refer to ACI 355.4-11, *Qualification of Post-Installed Adhesive Anchors in Concrete and Commentary* (2011c). These criteria, which include specific provisions for screw anchors and adhesive anchors, also reference ACI qualification standards for anchors. For postinstalled anchors in masonry, seismic prequalification procedures are contained in ICC-ES AC01, *Acceptance Criteria for Expansion Anchors in Masonry Elements* (2012b), AC58, *Acceptance Criteria for Adhesive Anchors in Masonry Elements* (2012a), and AC106, *Acceptance Criteria for Predrilled Fasteners (Screw Anchors) in Masonry* (2012e).

Other references to adhesives (such as in Section 13.5.7.2) apply not to adhesive anchors but to steel plates and other structural elements bonded or glued to the surface of another structural component with adhesive; such connections are generally nonductile.

C13.4.3 Installation Conditions.

Prying forces on anchors, which result from a lack of rotational stiffness in the connected part, can be critical for anchor design and must be considered explicitly.

For anchorage configurations that do not provide a direct mechanism to transfer compression loads (for example, a base plate that does not bear directly on a slab or deck but is supported on a threaded rod), the design for overturning must reflect the actual stiffness of base plates, equipment, housing, and other elements in the load path when computing the location of the compression centroid and the distribution of uplift loads to the anchors.

C13.4.4 Multiple Attachments.

Although the standard does not prohibit the use of single anchor connections, it is good practice to use at least two anchors in any load-carrying connection whose failure might lead to collapse, partial collapse, or disruption of a critical load path.

C13.4.5 Power-Actuated Fasteners.

Restrictions on the use of power-actuated fasteners are based on observations of failures of sprinkler pipe runs in the 1994 Northridge earthquake. Although it is unclear from the record to what degree the failures occurred because of poor installation, product deficiency, overload, or consequential damage, the capacity of power-actuated fasteners in concrete often varies more than that of drilled postinstalled anchors. The shallow embedment, small diameter, and friction mechanism of these fasteners make them particularly susceptible to the effects of concrete cracking. The suitability of power-actuated fasteners to resist tension in concrete should be demonstrated by simulated seismic testing in cracked concrete.

Where properly installed in steel, power-actuated fasteners typically exhibit reliable cyclic performance. Nevertheless, they should not be used singly to support suspended elements. Where used to attach cladding and metal decking, subassembly testing may be used to establish design capacities because the interaction among the decking, the subframe, and the fastener can only be estimated crudely by currently available analysis methods.

The exception permits the use of power-actuated fasteners for specific light-duty applications with upper limits on the load that can be resisted in these cases. All fasteners must have adequate capacity for the calculated loads, including prying forces.

The exception allows for the continued use of power-actuated fasteners in concrete for the vertical support of suspended acoustical tile or lay-in panel ceilings and for other light distributed systems such as small-diameter conduit held to the concrete surface with C-clips. Experience indicates that these applications have performed satisfactorily because of the high degree of redundancy and light loading. Other than ceilings, hung systems should not be included in this exception because of the potential for bending in the fasteners.

The exception for power-actuated fasteners in steel provides a conservative limit on loading. Currently, no accepted procedure exists for the qualification of power-actuated fasteners to resist earthquake loads.

C13.4.6 Friction Clips.

The term *friction clip* is defined in Section 11.2 in a general way to encompass C-type beam clamps, as well as cold-formed metal channel (strut) connections. Friction clips are suitable to resist seismic forces provided that they are properly designed and installed, but under no circumstances should they be relied on to resist sustained gravity loads. C-type clamps must be provided with restraining straps, as shown in Figure C13.4-1.

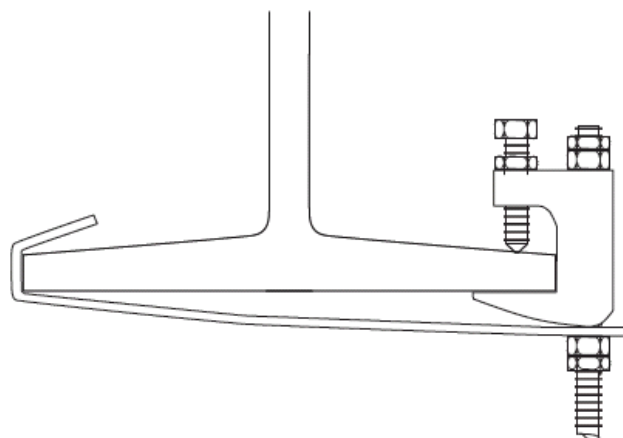

FIGURE C13.4-1 C-Type Beam Clamp Equipped with a Restraining Strap

C13.5 ARCHITECTURAL COMPONENTS

For structures in Risk Categories I through III, the requirements of Section 13.5 are intended to reduce property damage and life-safety hazards posed by architectural components and caused by loss of stability or integrity. When subjected to seismic motion, components may pose a direct falling hazard to building occupants or to people outside the building (as in the case of parapets, exterior cladding, and glazing). Failure or displacement of interior components (such as partitions and ceiling systems in exits and stairwells) may block egress.

For structures in Risk Category IV, the potential disruption of essential function caused by component failure must also be considered.

Architectural component failures in earthquakes can be caused by deficient design or construction of the component, interrelationship with another component that fails, interaction with the structure, or inadequate attachment or anchorage. For architectural components, attachment and anchorage are typically the most critical concerns related to their seismic performance. Concerns regarding loss of function are most often associated with mechanical and electrical components. Architectural damage, unless severe, can be accommodated temporarily. Severe architectural damage is often accompanied by significant structural damage.

C13.5.1 General.

Suspended architectural components are not required to satisfy the force and displacement requirements of Chapter 13, where prescriptive requirements are met. The requirements were relaxed in the 2005 edition of the standard to better reflect the consequences of the expected behavior. For example, impact of a suspended architectural ornament with a sheet metal duct may only dent the duct without causing a credible danger (assuming that the ornament remains intact). The reference to Section 13.2.3 allows the designer to consider such consequences in establishing the design approach.

Nonstructural components supported by chains or otherwise suspended from the structure are exempt from lateral bracing requirements, provided that they are designed not to inflict damage to themselves or any other component when subject to seismic motion. However, for the 2005 edition, it was determined that clarifications were needed on the type of nonstructural components allowed by these exceptions and the acceptable consequences of interaction between components. In ASCE 7-02, certain nonstructural components that could represent a fire hazard after an earthquake were exempted from meeting the Section 9.6.1 requirements. For example, gas-fired space heaters clearly pose a fire hazard after an earthquake but

were permitted to be exempted from the ASCE 7-02 Section 9.6.1 requirements. The fire hazard after the seismic event must be given the same level of consideration as the structural failure hazard when considering components to be covered by this exception. In addition, the ASCE 7-02 language was sometimes overly restrictive because it did not distinguish between credible seismic interactions and incidental interactions. In ASCE 7-02, if a suspended lighting fixture could hit and dent a sheet metal duct, it would have to be braced, although no credible danger is created by the impact. The new reference in Section 13.2.3 of ASCE 7-05 allowed the designer to consider whether the failures of the component and/or the adjacent components are likely to occur if contact is made. These provisions were carried into ASCE 7-10.

C13.5.2 Forces and Displacements.

Partitions and interior and exterior glazing must accommodate story drift without failure that will cause a life-safety hazard. Design judgment must be used to assess potential life-safety hazards and the likelihood of life-threatening damage. Special detailing to accommodate drift for typical gypsum board or demountable partitions is unlikely to be cost-effective, and damage to these components poses a low hazard to life safety. Damage in these partitions occurs at low drift levels but is inexpensive to repair.

If they must remain intact after strong ground motion, nonstructural fire-resistant enclosures and fire-rated partitions require special detailing that provides isolation from the adjacent or enclosing structure for deformation equivalent to the calculated drift (relative displacement). In-plane differential movement between structure and wall is permitted. Provision must be made for out-of-plane restraint. These requirements are particularly important in steel or concrete moment-frame structures, which experience larger drifts. The problem is less likely to be encountered in stiff structures, such as those with shear walls.

Differential vertical movement between horizontal cantilevers in adjacent stories (such as cantilevered floor slabs) has occurred in past earthquakes. The possibility of such effects should be considered in the design of exterior walls.

C13.5.3 Exterior Nonstructural Wall Elements and Connections.

Nonbearing wall panels that are attached to and enclose the structure must be designed to resist seismic (inertial) forces, wind forces, and gravity forces and to accommodate movements of the structure resulting from lateral forces and temperature change. The connections must allow wall panel movements caused by thermal and moisture changes and must be designed to prevent the loss of load-carrying capacity in the event of significant yielding. Where wind loads govern, common practice is to design connectors and panels to allow for not less than two times the story drift caused by wind loads determined, using a return period appropriate to the site location.

Design to accommodate seismic relative displacements often presents a greater challenge than design for strength. Story drifts can amount to 2 in. (50 mm) or more. Separations between adjacent panels are intended to limit contact and resulting panel misalignment or damage under all but extreme building response. Section 13.5.3, item 1, calls for a minimum separation of one-half in. (13 mm). For practical joint detailing and acceptable appearance, separations typically are limited to about three-fourths in. (19 mm). Manufacturing and construction tolerances for both wall elements and the supporting structure must be considered in establishing design joint dimensions and connection details.

Cladding elements, which are often stiff in-plane, must be isolated so that they do not restrain and are not loaded by drift of the supporting structure. Slotted connections can provide isolation, but connections with long rods that flex achieve the desired behavior without requiring precise installation. Such rods must be designed to resist tension and compression in addition to induced flexural stresses and brittle, low-cycle fatigue failure.

Full-story wall panels are usually rigidly attached to and move with the floor structure nearest the panel bottom and isolated at the upper attachments. Panels also can be vertically supported at the top connections

with isolation connections at the bottom. An advantage of this configuration is that failure of an isolation connection is less likely to result in complete detachment of the panel because it tends to rotate into the structure rather than away from it.

To minimize the effects of thermal movements and shrinkage on architectural cladding panels, connection systems are generally detailed to be statically determinate. Because the resulting support systems often lack redundancy, exacerbating the consequences of a single connection failure, fasteners must be designed for amplified forces and connecting members must be ductile. The intent is to keep inelastic behavior in the connecting members while the more brittle fasteners remain essentially elastic. To achieve this intent, the tabulated design coefficients values produce fastener design forces that are about 2.5 times those for the connecting members.

Limited deformability curtain walls, such as aluminum systems, are generally light and can undergo large deformations without separating from the structure. However, care must be taken in design of these elements so that low deformability components (as defined in Section 11.2) that may be part of the system, such as glazing panels, are detailed to accommodate the expected deformations without failure.

In Table 13.5-1, veneers are classified as either limited or low-deformability elements. Veneers with limited deformability, such as vinyl siding, pose little risk. Veneers with low deformability, such as brick and ceramic tile, are highly sensitive to the performance of the supporting substrate. Significant distortion of the substrate results in veneer damage, possibly including separation from the structure. The resulting risk depends on the size and weight of fragments likely to be dislodged and on the height from which the fragments would fall. Detachment of large portions of the veneer can pose a significant risk to life. Such damage can be reduced by isolating veneer from displacements of the supporting structure. For structures with flexible lateral force-resisting systems, such as moment frames and buckling-restrained braced frames, approaches used to design nonbearing wall panels to accommodate story drift should be applied to veneers.

The limits on length to diameter ratios are needed to ensure proper connection performance. Recent full-scale building shake table tests conducted at University of California, San Diego, demonstrated that sliding connections perform well when the rod is short. Longer rods in sliding connections bind if there is significant bending and rotation in the rod, which may lead to a brittle failure. For rods that accommodate drift by flexure, longer rods reduce inelastic bending demands and provide better performance. Since anchor rods used in sliding and bending may undergo inelastic action, the use of mild steel improves ductility.

Threaded rods subjected to bending have natural notches (the threads) and are therefore a concern for fatigue. In high-seismic applications, the response may induce a high bending demand and low-cycle fatigue. Cold-worked threaded rod offers significantly reduced ductility unless annealed. Rods meeting the requirements of ASTM F1554, Grade 36, in their as-fabricated condition (i.e., after threading) provide the desired level of performance. ASTM 1554 rods that fulfill the requirements of Supplement 1 for Grade 55 Bars and Anchor Bolts are also acceptable. Other grades that may also be acceptable include ASTM A36, A307, A572, Grade 50, and A588. Other connection configurations and materials may be used, provided that they are approved in accordance with ASCE 7-16 Section 1.3.1.3 and are designed to accommodate the story drift without brittle failure.

The reference to D_p has been changed to D_{pl} to reflect consideration of the earthquake Importance Factor on drift demands. Connections should include a means for accommodating erection tolerance so that the required connection capacity is maintained.

C13.5.4 Glass.

Glass is commonly secured to the window system framing by a glazing pocket built into the framing. This is commonly referred to as a *mechanically captured* or *dry-glazed* window system. Glass can also be secured to the window system framing with a structural silicone sealant. This is commonly referred to as a *wet-glazed* window system. Imposed loads are transferred from the glass to the window system framing

through the adhesive bond of the structural silicone sealant. ASTM C1401 *Standard Guide for Structural Sealant Glazing* (2014b) provides guidance and reference standards for manufacture, testing, design and installation of structural silicone sealant. This standard addresses glazing sloped to a maximum of 15° from vertical. For glazing slopes exceeding 15°, additional general building code requirements pertaining to sloped glazing and skylights apply.

C13.5.5 Out-of-Plane Bending.

The effects of out-of-plane application of seismic forces (defined in Section 13.3.1) on nonstructural walls, including the resulting deformations, must be considered. Where weak or brittle materials are used, conventional deflection limits are expressed as a proportion of the span. The intent is to preclude out-of-plane failure of heavy materials (such as brick or block) or applied finishes (such as stone or tile).

C13.5.6 Suspended Ceilings.

Suspended ceiling systems are fabricated using a wide range of building materials with differing characteristics. Some systems (such as gypsum board, screwed or nailed to suspended members) are fairly homogeneous and should be designed as light-frame diaphragm assemblies, using the forces of Section 13.3 and the applicable material-specific design provisions of Chapter 14. Others are composed of discrete elements laid into a suspension system and are the subject of this section.

Seismic performance of ceiling systems with lay-in or acoustical panels depends on support of the grid and individual panels at walls and expansion joints, integrity of the grid and panel assembly, interaction with other systems (such as fire sprinklers), and support for other nonstructural components (such as light fixtures and HVACR systems). Observed performance problems include dislodgement of tiles because of impact with walls and water damage (sometimes leading to loss of occupancy) because of interaction with fire sprinklers.

Suspended lath and plaster ceilings are not exempted from the requirements of this section because of their more significant mass and the greater potential for harm associated with their failure. However, the prescriptive seismic provisions of Section 13.5.6.2 and ASTM E580 for acoustical tile and lay-in panel ceilings, including the use of compression posts, are not directly applicable to these systems primarily because of their behavior as a continuous diaphragm and greater mass. As such, they require more attention to design and detailing, in particular for the attachment of the hanger wires to the structure and main carriers, the attachment of the cross-furring channels to main carriers, and the attachment of lath to cross-furring channels. Attention should also be given to the attachment of light fixtures and diffusers to the ceiling structure. Bracing should consider both horizontal and vertical movement of the ceiling, as well as discontinuities and offsets. The seismic design and detailing of lath and plaster ceilings should use rational engineering methods to transfer seismic design ceiling forces to the building structural elements.

The performance of ceiling systems is affected by the placement of seismic bracing and the layout of light fixtures and other supported loads. Dynamic testing has demonstrated that splayed wires, even with vertical compression struts, may not adequately limit lateral motion of the ceiling system caused by straightening of the end loops. Construction problems include slack installation or omission of bracing wires caused by obstructions. Other testing has shown that unbraced systems may perform well where the system can accommodate the expected displacements, by providing both sufficient clearance at penetrations and wide closure members, which are now required by the standard.

With reference to the exceptions in Section 13.5.6,

- The first exemption is based on the presumption that lateral support is accomplished by the surrounding walls for areas equal to or less than 144 ft² (13.4 m²) (e.g., a 12-ft by 12-ft (3.7-m by 3.7-m) room). The 144 ft² (13.4 m²) limit corresponds historically to an assumed connection

strength of 180 lb (4.5 N) and forces associated with requirements for suspended ceilings that first appeared in the 1976 Uniform Building Code.

- The second exemption assumes that planar, horizontal drywall ceilings behave as diaphragms (i.e., develop in-plane strength). This assumption is supported by the performance of drywall ceilings in past earthquakes.

C13.5.6.1 Seismic Forces.

Where the weight of the ceiling system is distributed nonuniformly, that condition should be considered in the design because the typical T-bar ceiling grid has limited ability to redistribute lateral loads.

C13.5.6.2 Industry Standard Construction for Acoustical Tile or Lay-In Panel Ceilings.

The key to good seismic performance is sufficiently wide closure angles at the perimeter to accommodate relative ceiling motion and adequate clearance at penetrating components (such as columns and piping) to avoid concentrating restraining loads on the ceiling system.

Table C13.5-1 provides an overview of the combined requirements of ASCE/SEI 7 and ASTM E580 (2014a). Careful review of both documents is required to determine the actual requirements.

Table C13.5-1 Summary of Requirements for Acoustical Tile or Lay-in Panel Ceilings

Item	Seismic Design Category C	Seismic Design Categories D, E, and F
Less Than or Equal to 144 ft ²		
NA	No requirements. (§1.4)	No requirements. (§1.4)
Greater than 144 ft ² but less than or equal to 1,000 ft ²		
Duty Rating	Only Intermediate or Heavy Duty Load Rated grid as defined by ASTM C635 may be used for commercial ceilings. (ASTM C635 sections 4.1.3.1, 4.1.3.2, & 4.1.3.3)	Heavy Duty Load Rating as defined in ASTM C635 is required. (§5.1.1)
Grid Connections	Minimum main tee connection and cross tee intersection strength of 60 lb. (§4.1.2)	Minimum main tee connection and cross tee intersection strength of 180 lb. (§5.1.2)
Vertical Suspension Wires	Vertical hanger wires must be a minimum of 12 gauge. (§4.3.1)	Vertical hanger wire must be a minimum of 12 gauge. (§5.2.7.1)
Vertical hanger wires maximum 4 ft on center. (§4.3.1)	Vertical hanger wires maximum 4 ft on center. (§5.2.7.1)	

Item	Seismic Design Category C	Seismic Design Categories D, E, and F
Vertical hanger wires must be sharply bent and wrapped with three turns in 3 in. or less. (§4.3.2)	Vertical hanger wires must be sharply bent and wrapped with three turns in 3 in. or less. (§5.2.7.2)	
All vertical hanger wires may not be more than 1 in 6 out of plumb without having additional wires counter-splayed. (§4.3.3)	All vertical hanger wires may not be more than 1 in 6 out of plumb without having additional wires counter-splayed. (§5.2.7.3)	
Any connection device from the vertical hanger wire to the structure above must sustain a minimum load of 90 lb. (§4.3.2)	Any connection device from the vertical hanger wire to the structure above must sustain a minimum load of 90 lb. (§5.2.7.2)	
Wires may not attach to or bend around interfering equipment without the use of trapezes. (§4.3.4)	Wires may not attach to or bend around interfering equipment without the use of trapezes. (§5.2.7.4)	
Lateral Bracing	Lateral bracing is not permitted. Ceiling is intended to “float” relative to balance of structure. Tee connections may be insufficient to maintain integrity if braces were included. NOTE 1)	Not required under 1,000 ft ² . For ceiling areas under 1,000 ft ² , perimeter and tee connections are presumed to be sufficiently strong to maintain integrity whether bracing is installed or not. (§5.2.8.1)
Perimeter	Perimeter closure (molding) width must be a minimum of seven-eighths in. (§4.2.2)	Perimeter closure (molding) width must be a minimum of 2 in. (§5.2.2)
Perimeter closures with a support ledge of less than seven-eighths-in. shall be supported by perimeter vertical hanger wires not more than 8 in. from the wall. (§4.2.3)	Two adjacent sides must be connected to the wall or perimeter closure. (§5.2.3)	
A minimum clearance of three-eighths in. must be maintained on all four sides. (§4.2.4)	A minimum clearance of three-fourths in. must be maintained on the other two adjacent sides. (§5.2.3)	

Item	Seismic Design Category C	Seismic Design Categories D, E, and F
Permanent attachment of grid ends is not permitted (§4.2.6)	Perimeter tees must be supported by vertical hanger wires not more than 8 in. from the wall. (§5.2.6)	
Perimeter tee ends must be prevented from spreading. (§4.2.5)	Perimeter tee ends must be prevented from spreading. (§5.2.4)	
Light Fixtures	Light fixtures must be positively attached to the grid by at least two connections, each capable of supporting the weight of the lighting fixture. (§4.4.1 and NEC)	Light fixtures must be positively attached to the grid by at least two connections, each capable of supporting the weight of the lighting fixture. (NEC, §5.3.1)
Surface-mounted light fixtures shall be positively clamped to the grid. (§4.4.2)	Surface-mounted light fixtures shall be positively clamped to the grid. (§5.3.2)	
Clamping devices for surface-mounted light fixtures shall have safety wires to the ceiling hanger or to the structure above. (§4.4.2)	Clamping devices for surface-mounted light fixtures shall have safety wires to the ceiling wire or to the structure above. (§5.3.2)	
Light fixtures and attachments weighing 10 lb or less require one number 12 gauge (minimum) hanger wire connected to the housing (e.g., canister light fixture). This wire may be slack. (§4.4.3)	When cross tees with a load-carrying capacity of less than 16 lb/ft are used, supplementary hanger wires are required. (§5.3.3)	
Light fixtures that weigh greater than 10 but less than or equal to 56 lb require two number 12 gauge (minimum) hanger wires connected to the housing. These wires may be slack. (§4.4.4)	Light fixtures and attachments weighing 10 lb or less require one 12-gauge minimum hanger wire connected to the housing and connected to the structure above. This wire may be slack. (§5.3.4)	
Light fixtures that weigh more than 56 lb require independent support from the structure. (§4.4.5)	Light fixtures that weigh greater than 10 but less than or equal to 56 lb require two number 12 gauge minimum hanger wires attached to the fixture housing and connected to the structure above. These wires may be slack. (§5.3.5)	

Item	Seismic Design Category C	Seismic Design Categories D, E, and F
Pendant-hung light fixtures shall be supported by a minimum 9-gauge wire or other approved alternate. (§4.4.6)	Light fixtures that weigh more than 56 lb require independent support from the structure by approved hangers. (§5.3.6)	
Rigid conduit is not permitted for the attachment of fixtures. (§4.4.7)	Pendant-hung light fixtures shall be supported by a minimum 9-gauge wire or other approved support. (§5.3.7)	
	Rigid conduit is not permitted for the attachment of fixtures. (§5.3.8)	
Mechanical Services	Flexibly mounted mechanical services weighing less than or equal to 20 lb must be positively attached to main runners or cross runners with the same load-carrying capacity as the main runners. (§4.5.1)	Flexibly mounted mechanical services weighing less than or equal to 20 lb must be positively attached to main runners or cross runners with the same load-carrying capacity as the main runners. (§5.4.1)
Flexibly mounted mechanical services weighing more than 20 lb but less than or equal to 56 lb must be positively attached to main runners or cross runners with the same load-carrying capacity as the main runners and require two 12-gauge (minimum) hanger wires. These wires may be slack. (§4.5.2)	Flexibly mounted mechanical services weighing more than 20 lb but less than or equal to 56 lb must be positively attached to main runners or cross runners with the same load-carrying capacity as the main runners and require two 12-gauge (minimum) hanger wires. These wires may be slack. (§5.4.2)	
Flexibly mounted mechanical services greater than 56 lb require direct support from the structure. (§4.5.3)	Flexibly mounted mechanical services greater than 56 lb require direct support from the structure. (§5.4.3)	
Supplemental Requirements	All ceiling penetrations must have a minimum of three-eighths in. clearance on all sides. (§4.2.4)	Direct concealed systems must have stabilizer bars or mechanically connected cross tees a maximum of 60 in. on center with stabilization within 24 in. of the perimeter. (§5.2.5)

Item	Seismic Design Category C	Seismic Design Categories D, E, and F
Bracing is required for ceiling plane elevation changes. (§5.2.8.6)		
Cable trays and electrical conduits shall be supported independently of the ceiling. (§5.2.8.7)		
2,500 ft ²		
All ceiling penetrations and independently supported fixtures or services must have closures that allow for a 1-in. movement. (§5.2.8.5)		
An integral ceiling sprinkler system may be designed by the licensed design professional to eliminate the required spacing of penetrations. (§5.2.8.8)		
A licensed design professional must review the interaction of nonessential ceiling components with essential ceiling components to prevent the failure of the essential components. (§5.7.1)		
Partitions	The ceiling may not provide lateral support to partitions. (§4.6.1)	Partition attached to the ceiling and all partitions greater than feet in height shall be laterally braced to the building structure. This bracing must be independent of the ceiling. (§5.5.1)
Partitions attached to the ceiling must use flexible connections to avoid transferring force to the ceiling. (§4.6.1)		
Exceptions	The ceiling weight must be less than 2.5 lb / ft ² , otherwise the prescribed construction for	None.

Item	Seismic Design Category C	Seismic Design Categories D, E, and F
	Seismic Design Categories D, E, and F must be used. (§4.1.1)	
Greater than but less than or equal to 2,500 ft²		
Lateral Bracing	No additional requirements.	Lateral force bracing (4, 12 gauge splay wires) is required within 2 in. of main tee/cross tee intersection and splayed 90 deg apart in the plan view, at maximum 45-deg angle from the horizontal and located 12 ft on center in both directions, starting 6 ft from walls. (§5.2.8.1 & §5.2.8.2)
Lateral force bracing must be spaced a minimum of 6 in. from unbraced horizontal piping or ductwork. (§5.2.8.3)		
Lateral force bracing connection strength must be a minimum of 250 lb. (§5.2.8.3)		
Rigid bracing designed to limit deflection at the point of attachment to less than 0.25 in. may be used in place of splay wires.		
Unless rigid bracing is used or calculations have shown that lateral deflection is less than one-fourth in., sprinkler heads and other penetrations shall have a minimum of 1-in. clear space in all directions. (§5.2.8.5)		
Greater than 2,500 ft²		
Special Considerations	No additional requirements.	Seismic separation joints with a minimum of three-fourths-in. axial movement, bulkhead, or

Item	Seismic Design Category C	Seismic Design Categories D, E, and F
		full-height partitions with the usual 2-in. closure and other requirements. (§5.2.9.1)
Areas defined by seismic separation joints, bulkheads, or full-height partitions must have a ratio of long to short dimensions of less than or equal to 4. (§5.2.9.1)		

Notes: There are no requirements for suspended ceilings located in structures assigned to Seismic Design Categories A and B. Unless otherwise noted, all section references in parentheses (§) refer to ASTM E580 (2014).

C13.5.6.2.1 Seismic Design Category C.

The prescribed method for SDC C is a floating ceiling. The design assumes a small displacement of the building structure caused by the earthquake at the ceiling and isolates the ceiling from the perimeter. The vertical hanger wires are not capable of transmitting significant movement or horizontal force into the ceiling system, and therefore the ceiling does not experience significant force or displacement as long as the perimeter gap is not exceeded. All penetrations and services must be isolated from the building structure for this construction method to be effective. If this isolation is impractical or undesirable, the prescribed construction for SDCs D, E, and F may be used.

C13.5.6.2.2 Seismic Design Categories D through F.

The industry standard construction addressed in this section relies on ceiling contact with the perimeter wall for restraint.

Typical splay wire lateral bracing allows for some movement before it effectively restrains the ceiling. The intent of the 2-in. (50-mm) perimeter closure wall angle is to permit back-and-forth motion of the ceiling during an earthquake without loss of support, and the width of the closure angle is important to good performance. This standard has been experimentally verified by large-scale testing conducted by ANCO Engineers, Inc., in 1983.

Extensive shake table testing using the protocol contained in ICC-ES AC156 by major manufacturers of suspended ceilings has been used to justify the use of perimeter clips designed to accommodate the same degree of movement as the closure angle while supporting the tee ends. These tests are conducted on 16-ft by 16-ft (4.9-m by 4.9-m) ceiling installations. Testing on larger ceiling systems reported by Rahmanishamsi et al. (2014) and Soroushian et al. (2012, 2014) indicates that the use of approved perimeter clips may lead to damage to the grid members and seismic clips, crushing of wall angles, and deformation of grid latches at moderate ground motion levels if the grid member loses contact with the horizontal leg of the closure angle or channel. A requirement has been added to screw the clips to the closure angle or channel to prevent this type of damage.

The requirement for a 1-in. (25-mm) clearance around sprinkler drops found in Section 13.5.6.2.2 (e) of ASCE/SEI 7-05 is maintained and is contained in ASTM E580.

This seismic separation joint is intended to break the ceiling into isolated areas, preventing large-scale force transfer across the ceiling. The new requirement to accommodate three-fourths-in. (19-mm) axial movement specifies the performance requirement for the separation joint.

The requirement for seismic separation joints to limit ceiling areas to 2,500 ft² (232.3 m²) is intended to prevent overload of the connections to the perimeter angle. Limiting the ratio of long to short dimensions to 4:1 prevents dividing the ceiling into long and narrow sections, which could defeat the purpose of the separation.

C13.5.6.3 Integral Construction.

Ceiling systems that use integral construction are constructed of modular pre-engineered components that integrate lights, ventilation components, fire sprinklers, and seismic bracing into a complete system. They may include aluminum, steel, and PVC components and may be designed using integral construction of ceiling and wall. They often use rigid grid and bracing systems, which provide lateral support for all the ceiling components, including sprinkler drops. This bracing reduces the potential for adverse interactions among components and eliminates the need to provide clearances for differential movement.

C13.5.7 Access Floors

C13.5.7.1 General.

In past earthquakes and in cyclic load tests, some typical raised access floor systems behaved in a brittle manner and exhibited little reserve capacity beyond initial yielding or failure of critical connections. Testing shows that unrestrained individual floor panels may pop out of the supporting grid unless they are mechanically fastened to supporting pedestals or stringers. This fault may be a concern, particularly in egress pathways.

For systems with floor stringers, it is accepted practice to calculate the seismic force, F_p , for the entire access floor system within a partitioned space and then distribute the total force to the individual braces or pedestals. For stringerless systems, the seismic load path should be established explicitly.

Overtopping effects subject individual pedestals to vertical loads well in excess of the weight, W_p , used in determining the seismic force, F_p . It is unconservative to use the design vertical load simultaneously with the design seismic force for design of anchor bolts, pedestal bending, and pedestal welds to base plates. “Slip-on” heads that are not mechanically fastened to the pedestal shaft and thus cannot transfer tension are likely unable to transfer to the pedestal the overturning moments generated by equipment attached to adjacent floor panels.

To preclude brittle failure, each element in the seismic load path must have energy-absorbing capacity. Buckling failure modes should be prevented. Lower seismic force demands are allowed for special access floors that are designed to preclude brittle and buckling failure modes.

C13.5.7.2 Special Access Floors.

An access floor can be a “special access floor” if the registered design professional opts to comply with the requirements of Section 13.5.7.2. Special access floors include construction features that improve the performance and reliability of the floor system under seismic loading. The provisions focus on providing an engineered load path for seismic shear and overturning forces. Special access floors are designed for smaller lateral forces, and their use is encouraged at facilities with higher nonstructural performance objectives.

C13.5.8 Partitions.

Partitions subject to these requirements must have independent lateral support bracing from the top of the partition to the building structure or to a substructure attached to the building structure. Some partitions are designed to span vertically from the floor to a suspended ceiling system. The ceiling system must be designed to provide lateral support for the top of the partition. An exception to this condition is provided to exempt bracing of light (gypsum board) partitions where the load does not exceed the minimum partition lateral load. Experience has shown that partitions subjected to the minimum load can be braced to the ceiling without failure.

C13.5.9 Glass in Glazed Curtain Walls, Glazed Storefronts, and Glazed Partitions.

The performance of glass in earthquakes falls into one of four categories:

1. The glass remains unbroken in its frame or anchorage.
2. The glass cracks but remains in its frame or anchorage while continuing to provide a weather barrier and to be otherwise serviceable.
3. The glass shatters but remains in its frame or anchorage in a precarious condition, likely to fall out at any time.
4. The glass falls out of its frame or anchorage, either in shards or as whole panels.

Categories 1 and 2 satisfy both Immediate Occupancy and Life Safety Performance Objectives. Although the glass is cracked in Category 2, immediate replacement is not required. Categories 3 and 4 cannot provide for immediate occupancy, and their provision of life safety depends on the post-breakage characteristics of the glass and the height from which it can fall. Tempered glass shatters into multiple, pebble-size fragments that fall from the frame or anchorage in clusters. These broken glass clusters are relatively harmless to humans when they fall from limited heights, but they could be harmful when they fall from greater heights.

C13.5.9.1 General.

Eq. (13.5-2) is derived from Sheet Glass Association of Japan (1982) and is similar to an equation in Bouwkamp and Meehan (1960) that permits calculation of the story drift required to cause glass-to-frame contact in a given rectangular window frame. Both calculations are based on the principle that a rectangular window frame (specifically, one that is anchored mechanically to adjacent stories of a structure) becomes a parallelogram as a result of story drift, and that glass-to-frame contact occurs when the length of the shorter diagonal of the parallelogram is equal to the diagonal of the glass panel itself. The value $\Delta_{fallout}$ represents the displacement capacity of the system, and D_p represents the displacement demand.

The 1.25 factor in the requirements described above reflects uncertainties associated with calculated inelastic seismic displacements of building structures. Wright (1989) states that post-elastic deformations, calculated using the structural analysis process may well underestimate the actual building deformation by up to 30%. It would therefore be reasonable to require the curtain wall glazing system to withstand 1.25 times the computed maximum interstory displacement to verify adequate performance.

The reason for the second exception to Eq. (13.5-2) is that the tempered glass, if shattered, would not produce an overhead falling hazard to adjacent pedestrians, although some pieces of glass may fall out of the frame.

C13.5.9.2 Seismic Drift Limits for Glass Components.

As an alternative to the prescriptive approach of Section 13.5.9.1, the deformation capacity of glazed curtain wall systems may be established by test.

C13.5.10 Egress Stairs and Ramps.

In the Christchurch earthquake of February 22, 2011, several buildings using precast concrete stairs provided with a sliding joint at one end experienced stair collapse (Canterbury Earthquakes Royal Commission 2012). In one notable case, the 18-story Forsyth Barr office building, the structure was otherwise largely undamaged. In all cases, the primary cause of collapse was loss of vertical bearing at the end connection due to building drift that exceeded the support detail capacity. These stairs, in general, were intended to serve as egress routes, and occupants were trapped in some of these buildings following the earthquake. In U.S. practice, precast stairs (Figure C13.5-1) are less common than steel-framed stairs (Figure C13.5-2), which are generally considered to be inherently flexible. But in shake table tests conducted at the University of California, San Diego, as part of the Network for Earthquake Engineering Simulation (NEES) project, “Full-Scale Structural and Nonstructural Building System Performance during Earthquakes and Post-Earthquake Fire,” connections of the commercial metal stair included in the test structure were shown to be brittle and susceptible to damage. Considering the critical nature of egress for life safety, specific attention to the ability of egress stairs to accept building drift demands is warranted. Effective sliding joints in typical steel stairs are complex to design and construct. Ductile connections, capable of accepting the drift without loss of vertical load-carrying capacity are often preferred. In such cases, sufficient ductility must be provided in these connections to accommodate multiple cycles at anticipated maximum drift levels. If drift is to be accommodated with full sliding connections lacking a fail-safe stop, additional length of bearing is required to prevent collapse where displacements exceed design levels. Where stair systems are rigidly attached to the structure, they must be included in the structure model, and the resultant forces must be accommodated, with overstrength, in the stair design.

These requirements do not apply to egress stair systems and ramps that are integral with the building structure since it is assumed that the seismic resistance of these systems is addressed in the overall building design. Examples include stairs and ramps comprising monolithic concrete construction, light-frame wood and cold-formed metal stair systems in multiunit residential construction, and integrally constructed masonry stairs.

C13.5.11 Penthouses and Rooftop Structures

Penthouses and rooftop structures can vary from small enclosures at the top of stairs and elevators to large structures covering 30% of the roof area. In past editions of the *Provisions*, penthouses were designed to the requirements of Chapter 13 as a nonstructural component, without any restrictions on the design of their lateral force-resisting systems. In the 2020 edition of the *Provisions*, the requirements for rooftop structures have been revised. The seismic lateral force for rooftop structures is now dependent on the lateral force-resisting system selected for the rooftop structure. Force-resisting systems may be selected from Chapter 12 or Chapter 15 and are subject to the system limitations and detailing requirements for the system selected. The seismic design force is determined in Section 13.3, using design coefficients obtained from Table 13.6-1. The values of these design coefficients depend on the value of R listed in Chapter 12 or Chapter 15 for the force-resisting system chosen. Chapter 15 permits the use of lower ductility force resisting systems in regions of high seismicity, but their use will result in higher lateral forces.

An option for the use of an undefined force-resisting system is provided, with a height limit of 28 feet (8534 mm) above the roof deck. The height limit was applied to penthouses designed using an undefined lateral system, since such a penthouse located in regions of high seismicity could potentially have low ductility. Height limits are applied to low ductility lateral systems permitted in Chapters 12 and 15, and such systems are in some cases limited to a single story. A height limit of 28 feet was selected to permit a penthouse with an undefined lateral system on buildings other than Type 1 construction, which could be used to enclose tanks or elevators that travel to the roof level. This height limit is consistent with the requirements of Section 1510.2 of the 2018 IBC. The exception for penthouses and rooftop structures framed by an extension of the building frame and designed in accordance with Chapter 12 was retained.

C13.6 MECHANICAL AND ELECTRICAL COMPONENTS

These requirements, focused on design of supports and attachments, are intended to reduce the hazard to life posed by loss of component structural stability or integrity. The requirements increase the reliability of component operation but do not address functionality directly. For critical components where operability is vital, Section 13.2.2 provides methods for seismically qualifying the component.

Traditionally, mechanical components (such as tanks and heat exchangers) without rotating or reciprocating components are directly anchored to the structure. Mechanical and electrical equipment components with rotating or reciprocating elements are often isolated from the structure by vibration isolators (using rubber acting in shear, springs, or air cushions). Heavy mechanical equipment (such as large boilers) may not be restrained at all, and electrical equipment other than generators, which are normally isolated to dampen vibrations, usually is rigidly anchored (for example, switch gear and motor control centers).

Two distinct levels of earthquake safety are considered in the design of mechanical and electrical components. At the usual safety level, failure of the mechanical or electrical component itself because of seismic effects poses no significant hazard. In this case, design of the supports and attachments to the structure is required to avoid a life-safety hazard. At the higher safety level, the component must continue to function acceptably after the design earthquake. Such components are defined as designated seismic systems in Section 11.2 and may be required to meet the special certification requirements of Section 13.2.2.

Not all equipment or parts of equipment need to be designed for seismic forces. Where I_p is specified to be 1.0, damage to, or even failure of, a piece or part of a component does not violate these requirements as long as a life-safety hazard is not created. The restraint or containment of a falling, breaking, or toppling component (or its parts) by means of bumpers, braces, guys, wedges, shims, tethers, or gapped restraints to satisfy these requirements often is acceptable, although the component itself may suffer damage.

Judgment is required to fulfill the intent of these requirements; the key consideration is the threat to life safety. For example, a nonessential air handler package unit that is less than 4 ft (1.2 m) tall bolted to a mechanical room floor is not a threat to life as long as it is prevented from significant displacement by having adequate anchorage. In this case, seismic design of the air handler itself is unnecessary. However, a 10-ft (3.0-m) tall tank on 6-ft (1.8-m) long angles used as legs, mounted on a roof near a building exit does pose a hazard. The intent of these requirements is that the supports and attachments (tank legs, connections between the roof and the legs, and connections between the legs and the tank), and possibly even the tank itself be designed to resist seismic forces. Alternatively, restraint of the tank by guys or bracing could be acceptable.

It is not the intent of the standard to require the seismic design of shafts, buckets, cranks, pistons, plungers, impellers, rotors, stators, bearings, switches, gears, non-pressure retaining casings and castings, or similar items. Where the potential for a hazard to life exists, the design effort should focus on equipment supports, including base plates, anchorages, support lugs, legs, feet, saddles, skirts, hangers, braces, and ties.

Many mechanical and electrical components consist of complex assemblies of parts that are manufactured in an industrial process that produces similar or identical items. Such equipment may include manufacturers' catalog items and often are designed by empirical (trial-and-error) means for functional and transportation loadings. A characteristic of such equipment is that it may be inherently rugged. The term "rugged" refers to an amplexness of construction that provides such equipment with the ability to survive strong motions without significant loss of function. By examining such equipment, an experienced design professional usually should be able to confirm such ruggedness. The results of an assessment of equipment ruggedness may be used in determining an appropriate method and extent of seismic design or qualification effort.

The revisions to Table 13.6-1 in ASCE/SEI 07-10 were the result of work done in recent years to better understand the performance of mechanical and electrical components and their attachment to the structure.

The primary concepts of flexible and rigid equipment and ductile and rugged behavior are drawn from SEAOC (1999), Commentary Section C107.1.7. Material on HVACR is based on ASHRAE (2000). Other material on industrial piping, boilers, and pressure vessels is based on the American Society of Mechanical Engineers codes and standards publications (ASME 2007, 2010a, 2010b).

C13.6.1 General.

The exception allowing unbraced suspended components has been clarified, addressing concerns about the type of nonstructural components allowed by these exceptions, as well as the acceptable consequences of interaction between components. In previous editions of the standard, certain nonstructural components that could represent a fire hazard after an earthquake were exempt from lateral bracing requirements. In the revised exception, reference to Section 13.2.3 addresses such concerns while distinguishing between credible seismic interactions and incidental interactions.

The seismic demand requirements are based on component structural attributes of flexibility (or rigidity) and ruggedness. Table 13.6-1 provides seismic coefficients based on judgments of the component flexibility, ductility, and ruggedness. It may also be necessary to consider the flexibility and ductility of the attachment system that provides seismic restraint.

Entries for components and systems in Table 13.6-1 are grouped and described to improve clarity of application. Components are divided into three broad groups, within which they are further classified depending on the type of construction or expected seismic behavior. For example, mechanical components include “air-side” components (such as fans and air handlers) that experience dynamic amplification but are light and deformable; “wet-side” components that generally contain liquids (such as boilers and chillers) that are more rigid and somewhat ductile; and rugged components (such as engines, turbines, and pumps) that are of massive construction because of demanding operating loads and that generally perform well in earthquakes, if adequately anchored.

C13.6.2 Mechanical Components and C13.6.3 Electrical Components.

Most mechanical and electrical equipment is inherently rugged and, where properly attached to the structure, has performed well in past earthquakes. Because the operational and transportation loads for which the equipment is designed typically are larger than those caused by earthquakes, these requirements focus primarily on equipment anchorage and attachments. However, designated seismic systems, which are required to function after an earthquake or which must maintain containment of flammable or hazardous materials, must themselves be designed for seismic forces or be qualified for seismic loading in accordance with Section 13.2.2.

The likelihood of post-earthquake operability can be increased where the following measures are taken:

1. Internal assemblies, subassemblies, and electrical contacts are attached sufficiently to prevent their being subjected to differential movement or impact with other internal assemblies or the equipment enclosure.
2. Operators, motors, generators, and other such components that are functionally attached to mechanical equipment by means of an operating shaft or mechanism are structurally connected or commonly supported with sufficient rigidity such that binding of the operating shaft is avoided.
3. Any ceramic or other nonductile components in the seismic load path are specifically evaluated.
4. Adjacent electrical cabinets are bolted together and cabinet lineups are prevented from impacting adjacent structural members.

Components that could be damaged, or could damage other components, and are fastened to multiple locations of a structure, must be designed to accommodate seismic relative displacements. Such components include bus ducts, cable trays, conduits, elevator guide rails, and piping systems. As discussed in Section C13.3.2.1, special design consideration is required where full story drift demands are concentrated in a fraction of the story height.

The design coefficients for air coolers (commonly known as fin fans) with integral support legs in Table 13.6-1 are taken from *Guidelines for Seismic Evaluation and Design of Petrochemical Facilities* (ASCE 2011). The values listed for “fans” in Table 13.6-1 are not intended for fin fans with integral support legs. (They do apply where fin fans are not supported on integral support legs.) As discussed in ASCE (2011), fin fans with integral support legs have not performed well in seismic events, such as the February 27, 2010, Chile earthquake.

Typically, fin fans are supported on pipe racks (Figure C13.6-1). Where the fin fan is supported on legs, this configuration generally creates a condition where a relatively rigid mass is supported on flexible legs on top of a pipe rack and can result in significantly higher seismic force demands. The support legs should be braced in both directions. Knee braces should be avoided. Vertical bracing should intersect columns at panel points with beams. Where geometrically practical, chevron bracing may be used. Whenever possible, it is recommended that the fin fan should be designed without vendor-supplied integral legs and should be supported directly on the pipe rack structural steel. In such cases, the design coefficients for fans apply.

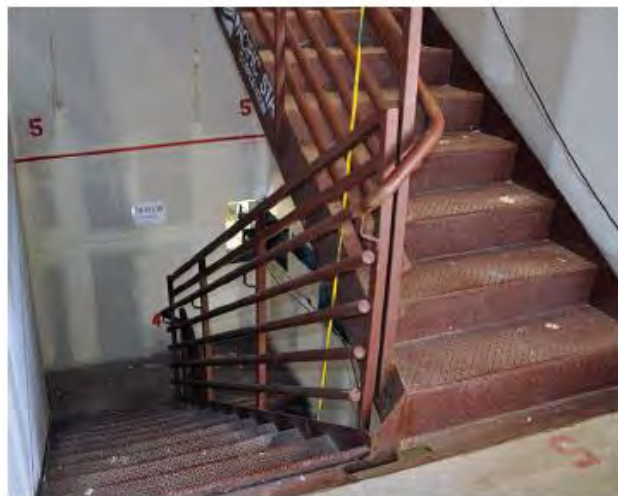

FIGURE C13.5-1 Precast Stair

Source: Courtesy of Tindall Corp.



FIGURE C13.5-2 Steel-Framed Exit Stair

Source: Courtesy of Tara Hutchinson.



FIGURE C13.6-1 Fin Fan Elevated on Integral Supports

Regardless of whether the fin fan vendor or the engineering contractor provides the supporting steel, the structural steel directly supporting the air coolers should be designed to the same level of seismic detailing required of the pipe rack structural steel.

Mechanical components with similar construction details used in fin fans (such as air-cooled heat exchangers, condensing units, dry coolers, and remote radiators) are grouped with fin fans because similar behavior is assumed.

C13.6.4 Component Supports.

The intent of this section is to require seismic design of all mechanical and electrical component supports to prevent sliding, falling, toppling, or other movement that could imperil life. Component supports are differentiated here from component attachments to emphasize that the supports themselves, as enumerated in the text, require seismic design even if they are fabricated by the mechanical or electrical component manufacturer. This need exists regardless of whether the mechanical or electrical component itself is designed for seismic loads.

In prior editions of the *Provisions*, a single lateral seismic force was used for both the mechanical or electrical component and for their supports and attachments, no matter how dissimilar the components and supports were. This could produce weak component supports, especially for distribution systems which tended to have high values of the component response coefficient, R_p , which was in use at that time.

The current provisions require a separate design for more complex equipment supports (equipment support structures and platforms) and for distribution system supports. The design coefficients for these equipment supports are selected based on the nature of the support lateral force-resisting system, rather than the type of equipment or system being supported. Force-resisting systems for equipment support structures and platforms may be selected from Chapter 12 or Chapter 15 and are subject to the system limitations and detailing requirements for the system selected. The seismic design force is determined in Section 13.3, using design coefficients obtained from Table 13.6-1. The values of these design coefficients depend on the value of R listed in Chapter 12 or Chapter 15 for the force-resisting system chosen. Chapter 15 permits the use of lower ductility force-resisting systems in regions of high seismicity, but this will result in higher lateral forces. An option for the use of an undefined support force-resisting system is provided. There are also special provisions for equipment support structures or platforms supported by a building or nonbuilding structure, where the likelihood of resonance is judged to be low.

Equipment supports are classified into 4 groups:

- Integral equipment supports, which are supports that are directly connected to both the component and the attachment to the structure or foundation where the nonstructural component acts as a part of the lateral force-resisting system. Examples include lugs, skirts, saddles, and short legs. An example is shown in Figure C13.6.4.1. Integral equipment supports are designed for the lateral force computed for the component itself. Integral supports are required to be designed as noted in Section 13.6.4, even if the component importance factor, I_p , is equal to 1.0 and seismic design of the component itself is not required.
- Equipment support structures, which are assemblies of structural members that provide support for a piece of equipment or system, including moment frames, braced frames, skids, or legs longer than 24 inches (610 mm). The properties of the equipment support structure may significantly influence the response of the nonstructural component. An example is shown in Figure C13.6.4.2. In this example, a component with an integral support is suspended from an equipment support structure. The component lateral design force is used to proportion the integral support, and a separate lateral force computation is made for the equipment support structure.
- Equipment support platforms, which are structures that support multiple nonstructural components or systems. An example is shown in Figure C13.6.4.3. Separate lateral force computations are made for equipment support platforms and the components installed on them.
- Distribution system supports, which are the hanging and bracing members and their connections that provide vertical and lateral supports for distribution systems. It also includes vertical cantilever

supports for distribution systems that are supported above rather than suspended below a floor or roof, such as pipe racks. An example of distribution supports for a system suspended below a floor is shown in Figure C13.6.4.4. Separate lateral force computations are made for distribution system supports and the distribution system itself.

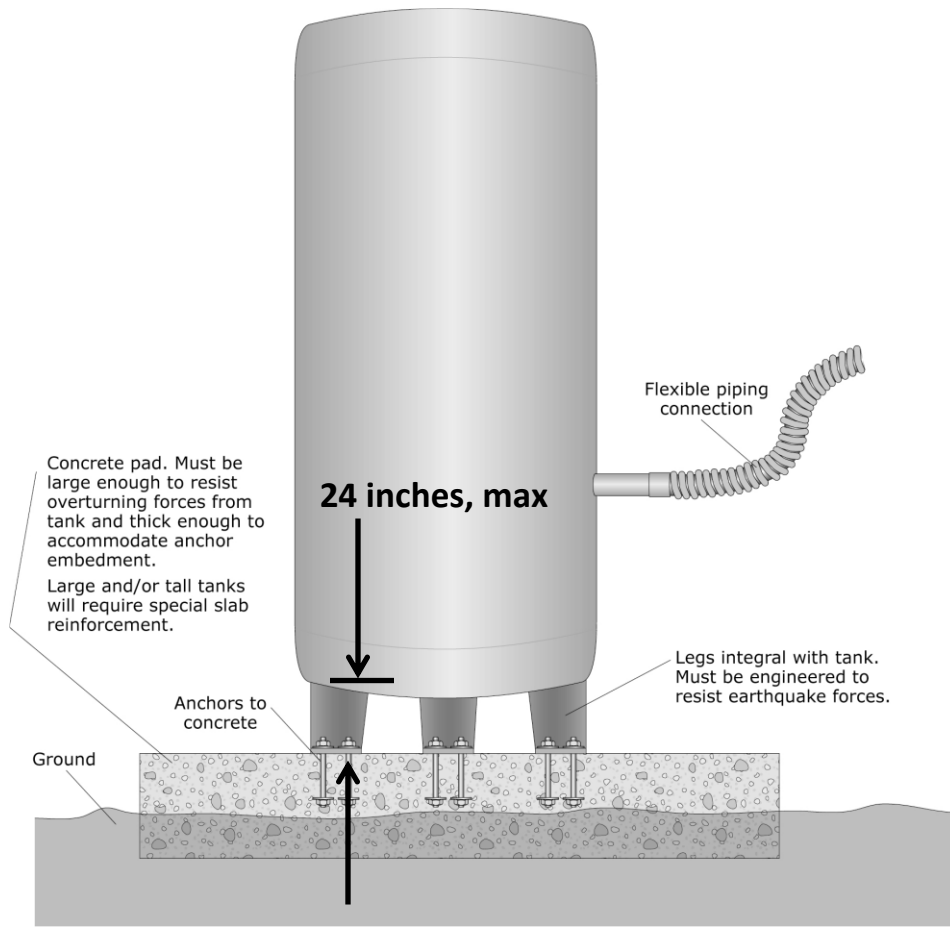

**Figure C13.6.4.1 Example of a nonstructural component with integral equipment supports.
(FEMA E-74)**

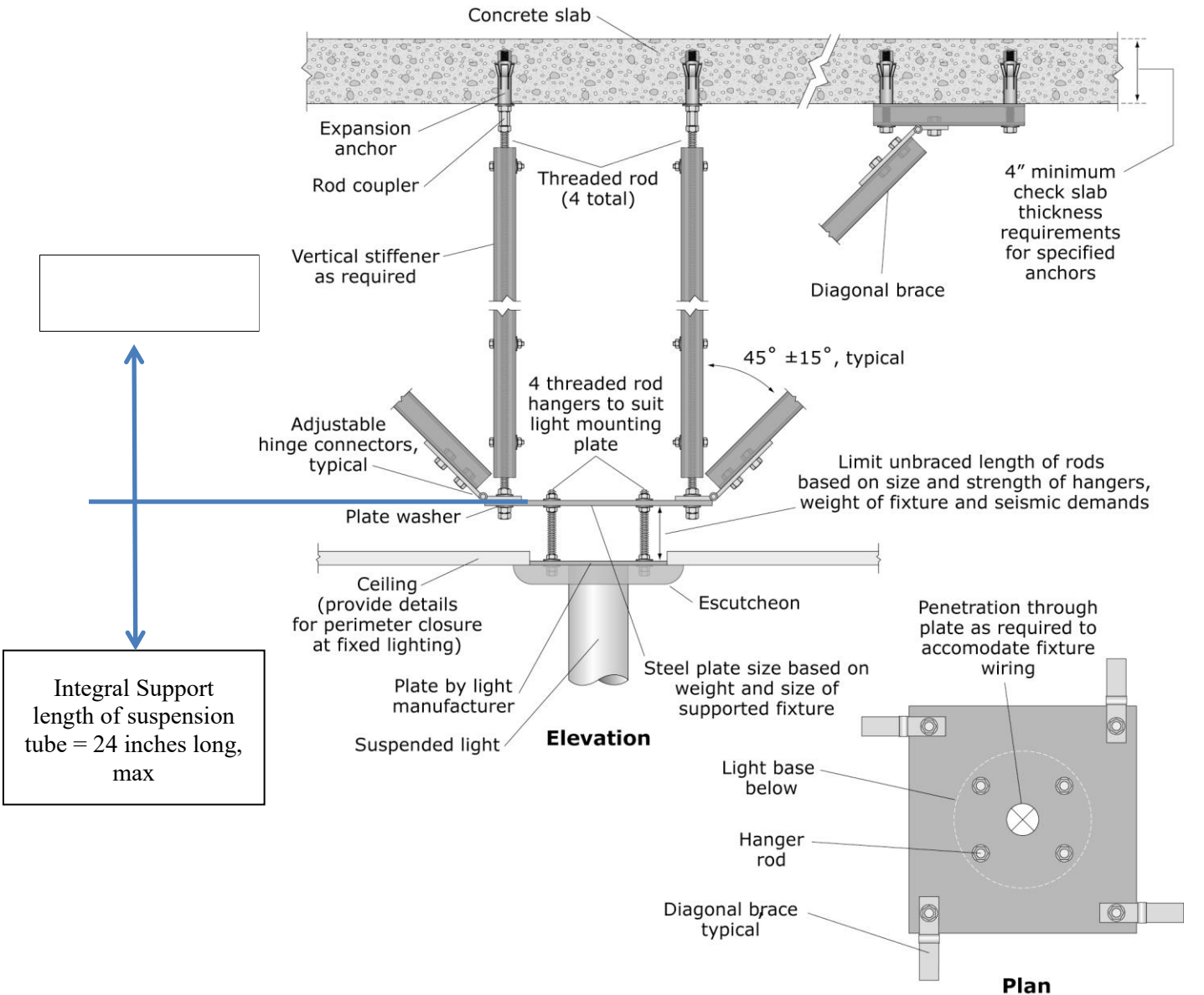

Figure C13.6.4.2 Example of an equipment support structure for a heavy light fixture. (FEMA E-74)

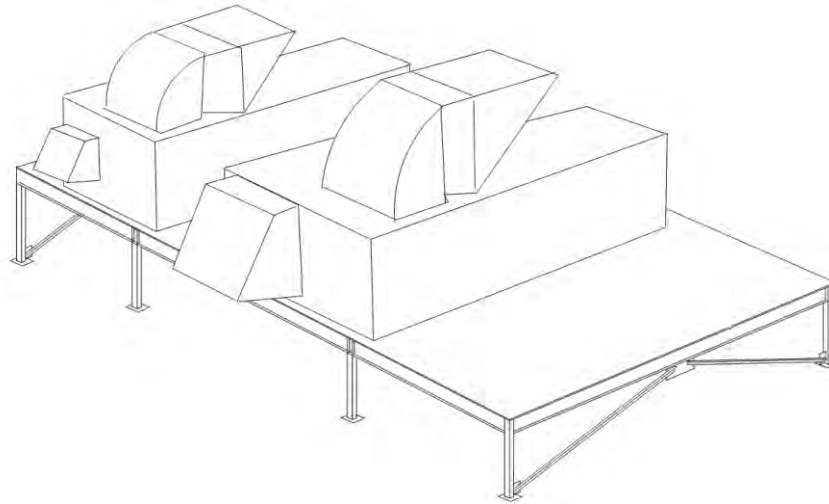

Figure C13.6.4.3 Example of an equipment support platform supporting two mechanical components.

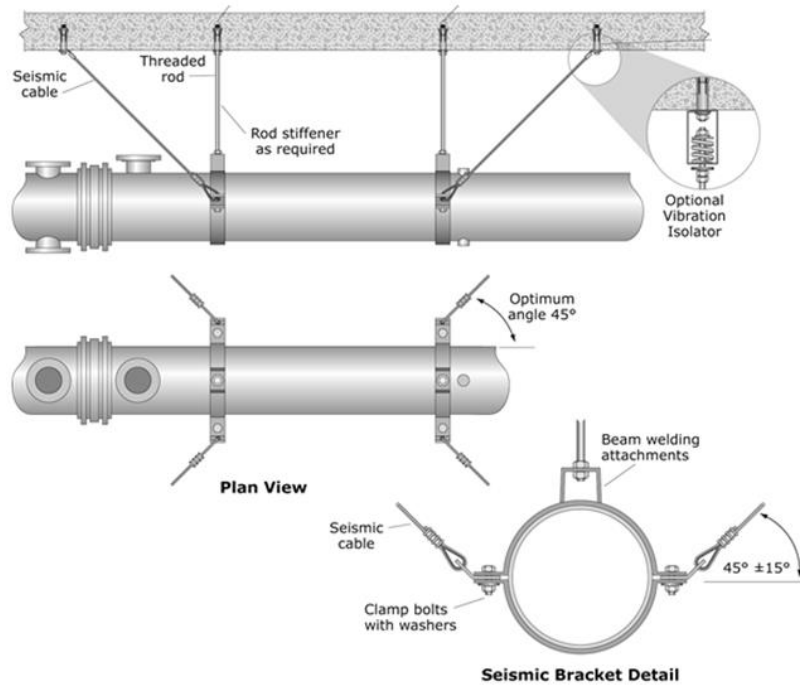

Figure C13.6.4.4 Example of a distribution system support for piping. (FEMA E-74)

C13.6.4.1 Design Basis.

Standard supports are those developed in accordance with a reference document (Section 13.1.7). Where standard supports are not used, the seismic design forces and displacement demands of Chapter 13 are used with applicable material-specific design procedures of Chapter 14.

C13.6.4.2 Design for Relative Displacement.

For some items, such as piping, seismic relative displacements between support points are of more significance than inertial forces. Components made of high-deformability materials such as steel or copper can accommodate relative displacements inelastically, provided that the connections also provide high deformability. Threaded and soldered connections exhibit poor ductility under inelastic displacements, even for ductile materials. Components made of less ductile materials can accommodate relative displacement effects only if appropriate flexibility or flexible connections are provided.

Detailing distribution systems that connect separate structures with bends and elbows makes them less prone to damage and less likely to fracture and fall, provided that the supports can accommodate the imposed loads.

C13.6.4.3 Support Attachment to Component.

As used in this section, “integral” relates to the manufacturing process, not the location of installation. For example, both the legs of a cooling tower and the attachment of the legs to the body of the cooling tower must be designed, even if the legs are provided by the manufacturer and installed at the plant. Also, if the cooling tower has an $I_p = 1.5$, the design must address not only the attachments (e.g., welds and bolts) of the legs to the component but also local stresses imposed on the body of the cooling tower by the support attachments.

C13.6.4.5 Additional Requirements.

As reflected in this section of the standard and in footnote b to Table 13.6-1, vibration-isolated equipment with snubbers is subject to amplified loads as a result of dynamic impact.

Most sheet metal connection points for seismic anchorage do not exhibit the same mechanical properties as bolted connections with structural elements. The use of Belleville washers improves the seismic performance of connections to equipment enclosures fabricated from sheet metal 7 gauge (0.18 in. (5 mm)) or thinner by distributing the stress over a larger surface area of the sheet metal connection interface, allowing for bolted connections to be torqued to recommended values for proper preload while reducing the tendency for local sheet metal tearing or bending failures or loosening of the bolted connection (Figure C13.6-2). The intrinsic spring loading capacity of the Belleville washer assists with long-term preload retention to maintain integrity of the seismic anchorage.



Failure of sheet metal base anchored with standard washer

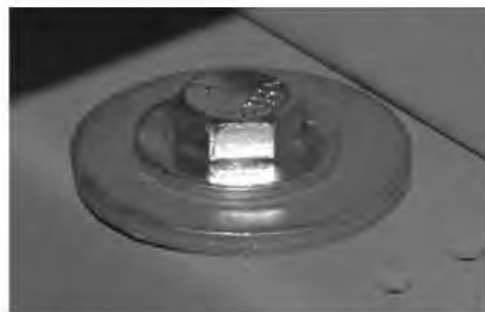

Anchorage equipped with Belleville washer

FIGURE C13.6-2 Equipment Anchorage with Belleville Washers

Source: Courtesy of Philip Caldwell.

Manufacturers test or design their equipment to handle seismic loads at the equipment “hard points” or anchor locations. The results of this design qualification effort are typically reflected in installation

instructions provided by the manufacturer. It is imperative that the manufacturer's installation instructions be followed. Where such guidance does not exist, the registered design professional should design appropriate reinforcement.

C13.6.5 Distribution Systems: Conduit, Cable Tray, and Raceways.

The term *raceway* is defined in several standards with somewhat varying language. As used here, it is intended to describe all electrical distribution systems including conduit, cable trays, and open and closed raceways. Experience indicates that a size limit of 2.5 in. (64 mm) can be established for the provision of flexible connections to accommodate seismic relative displacements that might occur between pieces of connected equipment because smaller conduit normally possesses the required flexibility to accommodate such displacements. See additional commentary pertaining to exemption of trapeze-supported systems in Section C13.1.4.

C13.6.6 Distribution Systems: Duct Systems.

Experience in past earthquakes has shown that HVACR duct systems are rugged and perform well in strong ground shaking. Bracing in accordance with ANSI/SMACNA 001 (2000) has been effective in limiting damage to duct systems. Typical failures have affected only system function, and major damage or collapse has been uncommon. Therefore, industry standard practices should prove adequate for most installations. Expected earthquake damage is limited to opening of duct joints and tears in ducts. Connection details that are prone to brittle failures, especially hanger rods subject to large amplitude cycles of bending stress, should be avoided. See additional commentary in Section C13.1.4.

Duct systems that carry hazardous materials or must remain operational during and after an earthquake are assigned a value of $I_p = 1.5$, and they require a detailed engineering analysis addressing leak tightness.

Lighter in-line components may be designed to resist the forces from Section 13.3 as part of the overall duct system design, whereby the duct attached to the in-line component is explicitly designed for the forces generated by the component. Where in-line components are more massive, the component must be supported and braced independently of the ductwork to avoid failure of the connections.

The requirements for flexible connections of unbraced piping to in-line components such as reheat coils applies regardless of the component weight.

C13.6.7 Distribution Systems: Piping and Tubing Systems.

Because of the typical redundancy of piping system supports, documented cases of total collapse of piping systems in earthquakes are rare; however, pipe leakage resulting from excessive displacement or overstress often results in significant consequential damage and in some cases loss of facility operability. Loss of fluid containment (leakage) normally occurs at discontinuities such as threads, grooves, bolted connectors, geometric discontinuities, or locations where incipient cracks exist, such as at the toe or root of a weld or braze. Numerous building and industrial national standards and guidelines address a wide variety of piping systems materials and applications. Construction in accordance with the national standards referenced in these provisions is usually effective in limiting damage to piping systems and avoiding loss of fluid containment under earthquake conditions.

ASHRAE (2000) and MSS (2001) are derived in large part from the predecessors of SMACNA (2008). These documents may be appropriate references for use in the seismic design of piping systems. Because the SMACNA standard does not refer to pipe stresses in the determination of hanger and brace spacing, however, a supplementary check of pipe stresses may be necessary when this document is used. ASME piping rules as given in the ASME BPVC and ASME B31 parts B31.1, B31.3, B31.5, B31.9, and B31.12 are normally used for high-pressure, high-temperature piping but can also conservatively be applied to other lower pressure, lower temperature piping systems. Code-compliant seismic design manuals prepared specifically for proprietary systems may also be appropriate references.

Although seismic design in accordance with Section 13.6.8 generally ensures that effective seismic forces do not fail piping, seismic displacements may be underestimated such that impact with nearby structural, mechanical, or electrical components could occur. In marginal cases, it may be advisable to protect the pipe with wrapper plates where impacts could occur, including at gapped supports. Insulation may in some cases also serve to protect the pipe from impact damage. Piping systems are typically designed for pressure containment, and piping designed with a factor of safety of three or more against pressure failure (rupture) may be inherently robust enough to survive impact with nearby structures, equipment, and other piping, particularly if the piping is insulated. Piping that has less than standard weight wall thickness may require the evaluation of the effects of impact locally on the pipe wall and may necessitate means to protect the pipe wall.

It is usually preferable for piping to be detailed to accommodate seismic relative displacements between the first seismic support upstream or downstream from connections and other seismically supported components or headers. This accommodation is preferably achieved by means of pipe flexibility or, where pipe flexibility is not possible, flexible supports. Piping not otherwise detailed to accommodate such seismic relative displacements must be provided with connections that have sufficient flexibility in the connecting element or in the component or header to avoid failure of the piping. The option to use a flexible connecting element may be less desirable because of the need for greater maintenance efforts to ensure continued proper function of the flexible element.

Grooved couplings, ball joints, resilient gasket compression fittings, other articulating-type connections, bellows expansion joints, and flexible metal hose are used in many piping systems and can serve to increase the rotational and lateral deflection design capacity of the piping connections.

Grooved couplings are classified as either rigid or flexible. Flexible grooved couplings demonstrate limited free rotational capacity. The free rotational capacity is the maximum articulating angle where the connection behaves essentially as a pinned joint with limited or negligible stiffness. The remaining rotational capacity of the connection is associated with conventional joint behavior, and design force demands in the connection are determined by traditional means.

Rigid couplings are typically used for high-pressure applications and usually are assumed to be stiffer than the pipe. Alternatively, rigid coupling may exhibit bilinear rotational stiffness with the initial rotational stiffness affected by installation.

Coupling flexibilities vary significantly between manufacturers, particularly for rigid couplings. Manufacturer's data may be available. Industrywide procedures for the determination of coupling flexibility are not currently available; however, some guidance for couplings may be found in the provisions for fire sprinkler piping, where grooved couplings are classified as either rigid or flexible on the basis of specific requirements on angular movement. In Section 3.5.4 of NFPA (2007), flexible couplings are defined as follows:

A listed coupling or fitting that allows axial displacement, rotation, and at least 1 degree of angular movement of the pipe without inducing harm on the pipe. For pipe diameters of 8 in. (203.2 mm) and larger, the angular movement shall be permitted to be less than 1 degree but not less than 0.5 degrees.

Couplings determined to be flexible on this basis are listed either with FM Global (2007) or UL (2004).

Piping component testing suggests that the ductility capacity of carbon steel threaded and flexible grooved piping component joints ranges between 1.4 and 3.0, implying an effective stress intensification of approximately 2.5. These types of connections have been classified as having limited deformability.

The allowable stresses for piping constructed with ductile materials assumed to be materials with high deformability, and not designed in accordance with an applicable standard or recognized design basis, are

based on values consistent with industrial piping and structural steel standards for comparable piping materials.

The allowable stresses for piping constructed with low-deformability materials, and not designed in accordance with an applicable standard or recognized design basis, are derived from values consistent with ASME standards for comparable piping materials.

For typical piping materials, pipe stresses may not be the governing parameter in determining the hanger and other support spacing. Other considerations, such as the capacity of the hanger and other support connections to the structure, limits on the lateral displacements between hangers and other supports to avoid impacts, the need to limit pipe sag between hangers to avoid the pooling of condensing gases, and the loads on connected equipment, may govern the design. Nevertheless, seismic span tables, based on limiting stresses and displacements in the pipe, can be a useful adjunct for establishing seismic support locations.

Piping systems' service loads of pressure and temperature also need to be considered in conjunction with seismic inertia loads. The potential for low ambient and lower than ambient operating temperatures should be considered in the designation of the piping system materials as having high or low deformability. High deformability may often be assumed for steels, particularly ASME listed materials operating at high temperatures, copper and copper alloys, and aluminum. Low deformability should be assumed for any piping material that exhibits brittle behavior, such as glass, ceramics, and many plastics.

Piping should be designed to accommodate relative displacements between the first rigid piping support and connections to equipment or piping headers often assumed to be anchors. Barring such design, the equipment or header connection could be designed to have sufficient flexibility to avoid failure. The specification of such flexible connections should consider the necessity of connection maintenance.

Where appropriate, a walkdown of the finally installed piping system by an experienced design professional familiar with seismic design is recommended, particularly for piping greater than 6-in. (152.4-mm) nominal pipe size, high-pressure piping, piping operating at higher than ambient temperatures, and piping containing hazardous materials. The need for a walkdown may also be related to the scope, function, and complexity of the piping system, as well as the expected performance of the facility. In addition to providing a review of seismic restraint location, orientation, and attachment to the structure, the walkdown verifies that the required separation exists between the piping and nearby structures, equipment, and other piping in the as-built condition.

C13.6.7.1 ASME Pressure Piping Systems.

In Table 13.6-1, the increased R_{po} values listed for ASME B31-compliant piping systems are intended to reflect the more rigorous design, construction, and quality control requirements, as well as the intensified stresses associated with ASME B31 designs.

Materials meeting ASME toughness requirements may be considered high-deformability materials.

C13.6.7.2 Fire Protection Sprinkler Piping Systems.

The lateral design procedures of NFPA (2016) have been revised for consistency with the ASCE/SEI 7 design approach while retaining traditional sprinkler system design concepts. Using conservative upper bound values of the various design parameters, a single lateral force coefficient, C_p , was developed. It is a function of the mapped short-period response parameter S_s . Stresses in the pipe and connections are controlled by limiting the maximum reaction at bracing points as a function of pipe diameter.

Other components of fire protection systems, e.g., pumps and control panels, are subject to the general requirements of ASCE/SEI 7.

Experience has shown that interaction of other nonstructural components and sprinkler drops and sprigs is a significant source of damage and can result in serious consequential damage as well as compromise the

performance of the fire protection system. Clearance for between sprinkler drops and sprigs and other nonstructural components needs to be addressed beyond NFPA 13. The minimum clearance value provided is based on judgment observations in past earthquakes. It is not the intent of this committee to require that sprinkler systems be field modified to accommodate these installed clearances if supports or equipment are installed after the sprinkler system is installed (i.e., the burden should not necessarily be on the sprinkler contractor to make the field modifications). It is the intent of this committee that the installation of permanently attached equipment, distribution systems, supports and fire sprinkler systems be coordinated such that the minimum clearance is maintained after their installation. As Building Information Systems become more widely used and nonstructural components and systems are detailed in the design phase of the project, maintaining these clearances should become easier to ensure by design.

C13.6.7.3 Exceptions.

The conditions under which the force requirements of Section 13.3 may be waived are based on observed performance in past earthquakes. The limits on the maximum hanger or trapeze drop (hanger rod length) must be met by all the hangers or trapezes supporting the piping system. See additional commentary in Section C13.1.4.

C13.6.9 Utility and Service Lines.

For essential facilities (Risk Category IV), auxiliary on-site mechanical and electrical utility sources are recommended.

Where utility lines pass through the interface of adjacent, independent structures, they must be detailed to accommodate differential displacement computed in accordance with Section 13.3.2 and including the factor of Section 12.2.1.

As specified in Section 13.1.3, nonessential piping whose failure could damage essential utilities in the event of pipe rupture may be considered designated seismic systems.

C13.6.10 Boilers and Pressure Vessels.

Experience in past earthquakes has shown that boilers and pressure vessels are rugged and perform well in strong ground motion. Construction in accordance with current requirements of the ASME *Boiler and Pressure Vessel Code* (ASME BPVC) has been shown to be effective in limiting damage to and avoiding loss of fluid containment in boilers and pressure vessels under earthquake conditions. It is, therefore, the intent of the standard that nationally recognized codes be used to design boilers and pressure vessels provided that the seismic force and displacement demands are equal to or exceed those outlined in Section 13.3. Where nationally recognized codes do not yet incorporate force and displacement requirements comparable to the requirements of Section 13.3, it is nonetheless the intent to use the design acceptance criteria and construction practices of those codes.

C13.6.11 Elevator and Escalator Design Requirements.

The ASME *Safety Code for Elevators and Escalators* (ASME A17.1) has adopted many requirements to improve the seismic response of elevators; however, they do not apply to some regions covered by this chapter. These changes are to extend force requirements for elevators to be consistent with the standard.

C13.6.11.3 Seismic Controls for Elevators.

ASME A17.1 Section 8.4.10.1.2, specifies the requirements for the location and sensitivity of seismic switches to achieve the following goals: (a) safe shutdown in the event of an earthquake severe enough to impair elevator operations, (b) rapid and safe reactivation of elevators after an earthquake, and (c) avoidance of unintended elevator shutdowns. This level of safety is achieved by requiring the switches to be in or near the elevator equipment room, by using switches located on or near building columns that respond to vertical

accelerations that would result from P and S waves, and by setting the sensitivity of the switches at a level that avoids false shutdowns because of non-seismic sources of vibration. The trigger levels for switches with horizontal sensitivity (for cases where the switch cannot be located near a column) are based on the experience with California hospitals in the Northridge earthquake of 1994. Elevators in which the seismic switch and counterweight derail device have triggered should not be put back into service without a complete inspection. However, in the case where the loss of use of the elevator creates a life-safety hazard, an attempt to put the elevator back into service may be attempted. Operating the elevator before inspection may cause severe damage to the elevator or its components.

The building owner should have detailed written procedures in place defining for the elevator operator and/or maintenance personnel which elevators in the facility are necessary from a post-earthquake, life-safety perspective. It is highly recommended that these procedures be in place, with appropriate personnel training, before an event occurs that is strong enough to trip the seismic switch.

C13.6.11.4 Retainer Plates.

The use of retainer plates is a low-cost provision to improve the seismic response of elevators.

C13.6.12 Rooftop Solar Panels.

Rooftop solar panels without positive attachment to the roof structure are limited to low-profile panels with a low height-to-depth ratio that respond by sliding on the roof surface without overturning. The amount of roof slope is limited because studies show that panels on sloped surfaces tend to displace in the downslope direction when subjected to seismic shaking, and the displacement increases with greater roof slope.

Displacement-based design of panels includes verifying that the panel remains safe if displaced. It needs to be verified that there is roof capacity to support the weight of the displaced panel and that wiring to the panel can accommodate the design panel displacement without damage.

Eq. (13.6-1) conservatively assumes a minimum coefficient of friction between the solar panel and the roof of 0.4. In cold-weather regions, the effects on the friction coefficient should be considered for Seismic Design Categories D, E, and F.

Structural interconnection between portions of a panel must be of adequate design strength, in tension or compression, and stiffness in order to account for the potential that frictional resistance to sliding will be different under some portions of the panel as a result of varying normal force and actual instantaneous values of friction coefficient for a given roof surface material.

The requirement for unattached panel to be bounded by a curb or parapet is usually satisfied by a curb at the roof edge. In lieu of being bounded by curbs or parapets at roof edges and offsets, the panel may be set back a larger distance from the edge.

Analytical and experimental studies of the seismic response of unattached solar panels are reported by Schellenberg et al. (2012) and Maffei et al. (2013).

Shake table testing and nonlinear time history analysis may also be used to predict panel displacements; however, for unattached panels, it is necessary to use input motions appropriate for predicting sliding displacement, which can be affected by content in the low-frequency range. See SEAOC (2012) for guidance on the performance of such testing and analysis.

C13.6.13 Other Mechanical and Electrical Components.

The material properties set forth in item 2 of this section are similar to those allowed in ASME BPVC and reflect the high factors of safety necessary for seismic, service, and environmental loads.

REFERENCES

- ACI. (2014). "Building code requirements for structural concrete and commentary." *ACI 318*, ACI, Farmington Hills, MI.
- American Concrete Institute (ACI). (2007). "Qualification of post-installed mechanical anchors in concrete and commentary." *ACI 355.2*, ACI, Farmington Hills, MI.
- American National Standards Institute/Sheet Metal and Air-Conditioning Contractors National Association (ANSI/SMACNA). (2000). "Seismic restraint manual: Guidelines for mechanical systems." *ANSI/SMACNA 001*, Chantilly, VA.
- ASCE. (2011). *Guidelines for seismic evaluation and design of petrochemical facilities*, 2nd Ed. ASCE, Reston, VA.
- American Society of Heating, Refrigerating, and Air-Conditioning Engineers (ASHRAE). (2000). *Practical guide to seismic restraint, RP-812*. ASHRAE, Atlanta, GA.
- American Society of Mechanical Engineers (ASME). (2007). "Safety code for elevators and escalators." *A17.1*, ASME, New York.
- ASME. (2010a). *Boiler and pressure vessel code*. ASME, New York.
- ASME. (2010b). *Standard for the seismic design and retrofit of above-ground piping systems*. ASME, New York.
- ANCO Engineers, Inc. (1983). *Seismic hazard assessment of non-structural components—Phase I*. Final Report for the National Science Foundation from ANCO Engineers, Inc., Culver City, CA, September.
- ASTM International. (2004). "Standard specification for the manufacture, performance, and testing of metal suspension systems for acoustical tile and lay-in panel ceiling." *ASTM C635*, West Conshohocken, PA.
- ASTM. (2014a). "Standard practice for installation of ceiling suspension systems for acoustical tile and lay-in panels for areas subject to earthquake ground motion." *ASTM E580/E580M-14*, West Conshohocken, PA.
- ASTM (2014b). "Standard guide for structural sealant glazing." *ASTM C1401*, West Conshohocken, PA.
- Bachman, R. E., and Dowty, S. M. (2008). *Nonstructural component or nonbuilding structure?* Bldg. Safety J. (April–May).
- Bachman, R. E., Drake, R. M., and Richter, P. J. (1993). *1994 Update to 1991 NEHRP provisions for architectural, mechanical, and electrical components and systems*. Letter report to the National Center for Earthquake Engineering Research, Feb. 22, 1993.
- Bouwkamp, J. G., and Meehan, J. F. (1960). *Drift limitations imposed by glass*. Proc. 2nd World Conference on Earthquake Engineering, Tokyo, 1763–1778.
- Canterbury Earthquakes Royal Commission. (2012). "The performance of Christchurch CBD buildings." Final Report, 2, 88–106, Canterbury, Wellington, UK.
- Dowell, R. K., and Johnson, T. P. (2013). "Evaluation of seismic overstrength factors for anchorage into concrete via dynamic shaking table tests." Report No. *SERP – 13/09*, San Diego State University, CA.
- FEMA E-74, 2015, *Reducing the risks of nonstructural earthquake damage – A practical guide*, Federal Emergency Management Agency, Washington, D.C.
- FEMA, 2018, "Seismic performance assessment of buildings, volume 3 – Supporting electronic materials and background documentation, Third edition." *FEMA P-58-3*, prepared by the Applied Technology Council for the Federal Emergency Management Agency, Washington, D.C.

- FM Global. (2007). *Approved standard for pipe couplings and fittings for aboveground fire protection systems*. (<http://www.fmglobal.com/assets/pdf/fmapprovals/1920.pdf>).
- Hadjian, A., and Ellison, E, 1986, *Decoupling of secondary systems for seismic analysis*, Journal of Pressure Vessel Technology, Transactions of the ASME, Vol. 108, February.
- International Code Council (ICC). (1976). *Uniform Building Code*, Whittier, CA.
- Institute of Electrical and Electronics Engineers, Inc. (IEEE). (2005). “IEEE recommended practices for seismic design of substations” *IEEE 693-2005*, Piscataway, NJ.
- International Code Council Evaluation Service (ICC-ES). (2010). “Seismic qualification by shake-table testing of nonstructural components and systems.” *ICC-ES AC156*, Whittier, CA.
- ICC-ES. (2012a). “Acceptance criteria for adhesive anchors in masonry elements.” *ICC-ES AC58*, Whittier, CA.
- ICC-ES. (2012b). “Acceptance criteria for expansion anchors in masonry elements.” *ICC-ES AC01*, Whittier, CA.
- ICC-ES. (2012c). “Acceptance criteria for mechanical anchors in concrete elements.” *ICC-ES AC193*, Whittier, CA.
- ICC-ES. (2012d). “Acceptance criteria for post-installed adhesive anchors in concrete elements.” *ICC-ES AC308*, Whittier, CA.
- ICC-ES. (2012e). “Acceptance criteria for predrilled fasteners (screw anchors) in masonry.” *ICC-ES AC106*, Whittier, CA.
- Kehoe, B., and Hachem, M. (2003). “Procedures for estimating floor accelerations.” *ATC 29-2*, Proceedings of the Seminar on Seismic Design, Performance, and Retrofit of Nonstructural Components in Critical Facilities, Newport Beach, CA, 361–374.
- Maffei, J., Fathali, S., Telleen, K., Ward, R., and Schellenberg, A. (2013). “Seismic design of ballasted solar arrays on low-slope roofs.” *J. Struct. Eng.*, doi: 10.1061/(ASCE)ST.1943-541X.0000865.
- Manufacturers Standardization Society of the Valve and Fitting Industry (MSS). (2001). “Bracing for piping systems seismic–wind–dynamic design, selection, application.” *MSS SP-127*, MSS, Vienna, VA.
- National Earthquake Hazards Reduction Program (NEHRP). (2009). *NEHRP recommended provisions for seismic regulations for new buildings and other structures*, NEHRP, Washington, DC.
- National Fire Protection Association (NFPA). (2007). “Standard for the installation of sprinkler systems.” *NFPA 13*, NFPA, Quincy, MA.
- NFPA. (2011). “National electric code.” *NFPA 70*, NFPA, Quincy, MA.
- Network for Earthquake Engineering Simulation (NEES). (2011). *Full-scale structural and nonstructural building system performance during earthquake and post-earthquake fire*. (<http://nees.ucsd.edu/projects/2011-five-story/>)
- NIST. (2018), “Recommendations for improved seismic performance of nonstructural components.” *NIST GCR 18-917-43*, National Institute of Standards and Technology, Gaithersburg, MD.
- Rahmanishamsi, E., Soroushian, S., and Maragakis, E. (2014). *Seismic response of ceiling/piping/partition systems in NEESR-GC system-level experiments*, Proc. ASCE Structures Congress, Boston.
- Schellenberg, A., Maffei, J., Miller, K., Williams, M., Ward, R., and Dent, M. (2012). *Shake-table testing of unattached rooftop solar arrays: Interim report, Subtask 4.1*. SunLink/Rutherford & Chekene Report for the California Solar Initiative (www.gosolarcalifornia.org/csi), Sacramento, CA.

- Sheet Glass Association of Japan. (1982). *Earthquake safety design of windows*, SGAJ, Tokyo.
- Sheet Metal and Air-Conditioning Contractors National Association (SMACNA). (2008). *Seismic restraint manual: Guidelines for mechanical systems, 3rd Ed.*, SMACNA, Chantilly, VA.
- Soroushian, S., et al. (2014). *A comparative study of sub-system and system level experiments of suspension ceiling systems*, Proc. 10th U.S. National Conference on Earthquake Engineering, Anchorage, AK.
- Soroushian, S., Reinhorn, A., Rahmanishamsi, E., Ryu, K., and Maragakis, M. (2012). *Seismic response of ceiling/sprinkler piping nonstructural systems in nees tips/nees nonstructural/nied collaborative tests on a full scale 5-story building*, Proc. ASCE Structures Congress, Chicago.
- Soulages, J. R., and Weir, R. (2011). "Cyclic testing of pipe trapezes with rigid hanger assemblies," Proc. 80th Structural Engineers Association of California Annual Convention, Las Vegas, NV.
- Structural Engineers Association of California (SEAOC). (1999). *Recommended lateral force requirements and commentary*, SEAOC, Sacramento, CA.
- SEAOC. (2012). "Structural seismic requirements and commentary for rooftop solar photovoltaic arrays." *Report SEAOC-PVI-2012*, SEAOC, August.
- Underwriter Laboratories (UL). (2004). "Rubber gasketed fittings for fire-protection service." *UL 213*, Northbrook, IL.
- U.S. Department of Defense (DOD). (2007). "Seismic design for buildings." *UFC 3-310-04*, DOD, Unified Facilities Criteria, Washington, DC.
- U.S. Army. (1986). "Seismic design guidelines for essential buildings." *TM 5-809-1*, Joint Departments of the Army, Navy, and Air Force., Washington, DC.
- Wright, P. D. (1989). *The development of a procedure and rig for testing the racking resistance of curtain wall glazing*. BRANZ Study Report 17, Building Research Association of New Zealand (BRANZ), Porirua, New Zealand.

OTHER REFERENCES (NOT CITED)

- ACI. (2011a). "Building code requirements and specification for masonry structures and related commentaries." *ACI 530/530.1*, ACI, Farmington Hills, MI.
- ACI. (2011b). "Building code requirements for structural concrete and commentary." *ACI 318*, ACI, Farmington Hills, MI.
- ACI. (2011c). "Qualification of post-installed adhesive anchors in concrete and commentary." *ACI 355.4*, ACI, Farmington Hills, MI.
- ASTM International. (2007). "Standard specification for the manufacture, performance, and testing of metal suspension systems for acoustical tile and lay-in panel ceilings." *ASTM C635/C635M*, West Conshohocken, PA.
- ASTM. (2013a). "Standard specification for the manufacture, performance, and testing of metal suspension systems for acoustical tile and lay-in panel ceilings." *ASTM C635/C635M-13a*, West Conshohocken, Penn.
- ASTM. (2013b). "Standard practice for installation of metal ceiling suspension systems for acoustical tile and lay-in panels." *ASTM C636/C636M-13*, West Conshohocken, PA.
- Bachman, R. E, and Drake, R. M. (1996). *A study to empirically validate the component response modification factors in the 1994 NEHRP Provisions design force equations for architectural, mechanical, and electrical components*. Letter report to the National Center for Earthquake Engineering Research, July.

- Bachman, R. E., Drake, R. M., and Richter, P. J. (1993). *1994 update to 1991 NEHRP Provisions for architectural, mechanical, and electrical components and systems*. Letter report to the National Center for Earthquake Engineering Research, February 22.
- Behr, R. A., and Belarbi, A. (1996). "Seismic test methods for architectural glazing systems." *Earthq. Spectra*, 12(1), 129–143.
- Behr, R. A., Belarbi, A., and Brown, A. T. (1995). "Seismic performance of architectural glass in a storefront wall system." *Earthq. Spectra*, 11(3), 367–391.
- Drake, R. M., and Bachman, R. E. (1994). *1994 NEHRP provisions for architectural, mechanical, and electrical components*. Proc. 5th United States National Conference on Earthquake Engineering, Chicago.
- Drake, R. M., and Bachman, R. E. (1995). *Interpretation of instrumented building seismic data and implications for building codes*. Proc. 1995 SEAOC Annual Convention, Squaw Creek, CA.
- Drake, R. M., and Bachman, R. E. (1996). "NEHRP provisions for 1994 for nonstructural components." *J. Arch. Engrg.*, 2(1), 26–31.
- Federal Emergency Management Agency (FEMA), "FEMA E-74 Reducing the risks of nonstructural earthquake damage—A practical guide," 4th Ed., *FEMA, Dec. 2012, 6-144–6-153*.
- Fleischmann, R. B., Restrepo, J. I., and Pampanin, S. (2014). "Damage evaluations of precast concrete structures in the 2010–2011 canterbury earthquake sequence," *EERI Earthq. Spectra*, 30(1), 277–306.
- Gates, W. E., and McGavin, G. (1998). "Lessons learned from the 1994 Northridge earthquake on the vulnerability of nonstructural systems." Proc. seminar on seismic design, retrofit, and performance of nonstructural components, *ATC-29-1*, Applied Technology Council, Redwood City, CA, 93–101.
- Haroun, M. A., and Housner, G. W. (1981). "Seismic design of liquid storage tanks." *J. Tech. Councils of ASCE*, 107(1), 191–207.
- Higgins, C. (2009) "Prefabricated steel stair performance under combined seismic and gravity loads," *J. Struct. Eng.*, doi: 10.1061/(ASCE)0733-9445(2009)135:2(122), 122–129.
- Pantelides, C. P., Truman, K. Z., Behr, R. A., and Belarbi, A. (1996). "Development of a loading history for seismic testing of architectural glass in a shop-front wall system." *Engrg. Struct.*, 18(12), 917–935.
- Pantoli, E., Chen, M., Hutchinson, T., Underwood, G., and Hildebrand, M. (2013). *Shake table testing of a full-scale five-story building: seismic performance of precast concrete cladding panels*, 4th ECCOMAS Thematic Conference on Computational Methods in Structural Dynamics and Earthquake Engineering (COMPDYN 2013), Kos Island, Greece, June 12–14.
- Trautner, C., Hutchinson, T., Grosser, P. (2014). *Cyclic behavior of structural base plate connections with ductile fastening failure: component test results*, 10th U.S. National Conference on Earthquake Engineering, Anchorage, AK.

Page intentionally left blank.

COMMENTARY TO CHAPTER 14, MATERIAL-SPECIFIC SEISMIC DESIGN AND DETAILING REQUIREMENTS

Because seismic loading is expected to cause nonlinear behavior in structures, seismic design criteria require not only provisions to govern loading but also provisions to define the required configurations, connections, and detailing to produce material and system behavior consistent with the design assumptions. Thus, although ASCE/SEI 7-10 is primarily a loading standard, compliance with Chapter 14, which covers material-specific seismic design and detailing, is required. In general, Chapter 14 adopts material design and detailing standards developed by material standards organizations. These material standards organizations maintain complete commentaries covering their standards, and such material is not duplicated here.

C14.0 SCOPE

The scoping statement in this section clarifies that foundation elements are subject to all of the structural design requirements of the standard.

C14.1 STEEL

C14.1.1 Reference Documents.

This section lists a series of structural standards published by the American Institute of Steel Construction (AISC), the American Iron and Steel Institute (AISI), the American Society of Civil Engineers (ASCE/SEI), the Steel Deck Institute (SDI), and the Steel Joist Institute (SJI), which are to be applied in the seismic design of steel members and connections in conjunction with the requirements of ASCE/SEI 7. The AISC references are available free of charge in electronic format at www.aisc.org; the AISI references are available on www.steel.org; the SDI references are available as a free download at www.sdi.org; and the SJI references are available as a free download at www.steeljoist.org.

C14.1.2 Structural Steel

C14.1.2.1 General.

This section adopts AISC 360 (2016) by direct reference. The specification applies to the design of the structural steel system or systems with structural steel acting compositely with reinforced concrete. In particular, the document sets forth criteria for the design, fabrication, and erection of structural steel buildings and other structures, where other structures are defined as structures designed, fabricated, and erected in a manner similar to buildings, with building-like vertical and lateral load-resisting elements. The document includes extensive commentary.

C14.1.2.2 Seismic Requirements for Structural Steel Structures

C14.1.2.2.1 Seismic Design Categories B and C.

For the lower Seismic Design Categories (SDCs) B and C, a range of options are available in the design of a structural steel lateral force-resisting system. The first option is to design the structure to meet the design and detailing requirements in AISC 341 (2016) for structures assigned to higher SDCs, with the corresponding seismic design parameters (R , Ω_0 , and C_d). The second option, presented in the exception, is to use an R factor of 3 (resulting in an increased base shear), an Ω_0 of 3, and a C_d value of 3 but without the specific seismic design and detailing required in AISC 341 (2016). The basic concept underlying this option is that design for a higher base shear force results in essentially elastic response that compensates for the limited ductility of the members and connections. The resulting performance is considered comparable to that of more ductile systems.

C14.1.2.2.2 Seismic Design Categories D through F.

For the higher SDCs, the engineer must follow the seismic design provisions of AISC 341 (2016) using the seismic design parameters specified for the chosen structural system, except as permitted in Table 15.4-1. For systems other than those identified in Table 15.4-1, it is not considered appropriate to design structures without specific design and detailing for seismic response in these high SDCs.

C14.1.3 COLD-FORMED STEEL

C14.1.3.1 General.

This section adopts two standards by direct reference: ANSI/AISI S100, *North American Specification for the Design of Cold-Formed Steel Structural Members* (2016), and ASCE/SEI 8, *Specification for the Design of Cold Formed Stainless Steel Structural Members* (2002).

Both of the adopted reference documents have specific limits of applicability. ANSI/AISI S100 (2016) (Section A1.1) applies to the design of structural members that are cold-formed to shape from carbon or low-alloy steel sheet, strip, plate, or bar not more than 1 in. (25 mm) thick. ASCE/SEI 8 (2002) (Section 1.1.1) governs the design of structural members that are cold-formed to shape from annealed and cold-rolled sheet, strip, plate, or flat bar stainless steels. Both documents focus on load-carrying members in buildings; however, allowances are made for applications in nonbuilding structures, if dynamic effects are considered appropriately.

Within each document, there are requirements related to general provisions for the applicable types of steel; design of elements, members, structural assemblies, connections, and joints; and mandatory testing. In addition, ANSI/AISI S100 contains a chapter on the design of cold-formed steel structural members and connections undergoing cyclic loading. Both standards contain extensive commentaries.

C14.1.3.2 Seismic Requirements for Cold-Formed Steel Structures.

This section adopts three standards by direct reference—AISI S100 (2016), ASCE/SEI 8 (2002), and AISI S400 (2015). Cold-formed steel and stainless-steel members that are part of a seismic force-resisting system listed in Table 12.2-1 must be detailed in accordance with the appropriate base standard: AISI S100 or ASCE 8.

The section also adopts a reference to AISI S400, which includes additional design provisions for a specific cold-formed steel seismic force-resisting system entitled “cold-formed steel—special bolted moment frame” or CFS-SBMF. Sato and Uang (2007) have shown that this system experiences inelastic deformation at the bolted connections because of slip and bearing during significant seismic events. To develop the designated mechanism, requirements based on capacity design principles are provided for the design of the beams, columns, and associated connections. The document has specific requirements for the application of quality assurance and quality control procedures.

C14.1.4 Cold-Formed Steel Light-Frame Construction

C14.1.4.1 General.

This subsection of cold-formed steel relates to light-frame construction, which is defined as a method of construction where the structural assemblies are formed primarily by a system of repetitive wood or cold-formed steel framing members or subassemblies of these members (Section 11.2 of this standard). It adopts Section I4 of AISI S100 (2016), which directs the user to an additional suite of AISI standards, including ANSI/AISI S240 and ANSI/AISI S400.

In addition, all of these documents include commentaries to aid users in the correct application of their requirements.

C14.1.4.2 Seismic Requirements for Cold-Formed Steel Light-Frame Construction.

Cold-formed steel structural members and connections in seismic force-resisting systems and diaphragms must be designed in accordance with the additional provisions of ANSI/AISI S400 in seismic design categories (SDC) D, E, or F, or wherever the seismic response modification coefficient, R , used to determine the seismic design forces is taken other than 3. In particular, this requirement includes all entries from Table 12.2-1 of this standard for “light-frame (cold-formed steel) walls sheathed with wood structural panels & mldr; or steel sheets,” “light-frame walls with shear panels of all other materials” (e.g., gypsum board and fiberboard panels), and “light-frame wall systems using flat strap bracing.”

C14.1.4.3 Prescriptive Cold-Formed Steel Light-Frame Construction.

This section adopts ANSI/AISI S230, *Standard for Cold-Formed Steel Framing—Prescriptive Method for One and Two Family Dwellings*, which applies to the construction of detached one- and two-family dwellings, townhouses, and other attached single-family dwellings not more than two stories in height using repetitive in-line framing practices (Section A1). This document includes a commentary to aid the user in the correct application of its requirements.

C14.1.5 Cold-Formed Steel Deck Diaphragms.

This section adopts the applicable standards for the general design of cold-formed steel deck diaphragms and steel roof, noncomposite floor, and composite floor deck. The SDI standards also reference ANSI/AISI S100 for materials and determination of cold-formed steel cross section strength and specify additional requirements specific to steel deck design and installation.

Additionally, design of cold-formed steel deck diaphragms is to be based on ANSI/AISI S310. All fastener design values (welds, screws, power-actuated fasteners, and button punches) for attaching deck sheet to deck sheet or for attaching the deck to the building framing members must be per ANSI/AISI S310 or specific testing prescribed in ANSI/AISI 310. All cold-formed steel deck diaphragm and fastener design properties not specifically included in ANSI/AISI S310 must be approved for use by the authorities in whose jurisdiction the construction project occurs. Deck diaphragm in-plane design forces (seismic, wind, or gravity) must be determined per ASCE 7, Section 12.10.1. Cold-formed steel deck manufacturer test reports prepared in accordance with this provision can be used where adopted and approved by the authority having jurisdiction for the building project. The *Diaphragm Design Manual* produced by the Steel Deck Institute (2015) is also a reference for design values.

Cold-formed steel deck is assumed to have a corrugated profile consisting of alternating up and down flutes that are manufactured in various widths and heights. Use of flat sheet metal as the overall floor or roof diaphragm is permissible where designed by engineering principles, but it is beyond the scope of this section. Flat or bent sheet metal may be used as closure pieces for small gaps or penetrations or for shear transfer over short distances in the deck diaphragm where diaphragm design forces are considered.

Cold-formed steel deck diaphragm analysis must include design of chord members at the perimeter of the diaphragm and around interior openings in the diaphragm. Chord members may be steel beams attached to the underside of the steel deck designed for a combination of axial loads and bending moments caused by acting gravity and lateral loads.

Where diaphragm design loads exceed the bare steel deck diaphragm design capacity, then either horizontal steel trusses or a structurally designed concrete topping slab placed over the deck must be provided to distribute lateral forces. Where horizontal steel trusses are used, the cold-formed steel deck must be designed to transfer diaphragm forces to the steel trusses. Where a structural concrete topping over the deck is used as the diaphragm, the diaphragm chord members at the perimeter of the diaphragm and edges of interior openings must be either (a) designed flexural reinforcing steel placed in the structural concrete topping or (b) steel beams located under the deck with connectors (that provide a positive connection) as required to transfer design shear forces between the concrete topping and steel beams.

C14.1.5.1 Add the following commentary to AISI S400**F3 Bare Steel Deck Diaphragms**

The stiffness and available strength of steel deck diaphragms is provided in AISI S310. However, AISI S310 does not cover seismic design considerations. This Standard recognizes that in some situations the applicable building code may require that the diaphragm provide energy dissipation for desired structural performance. For example, in rigid wall flexible diaphragm (RWFD) structures research has shown the benefits of and demands for energy dissipation in the roof diaphragm (FEMA 2015, Koliou et al. 2016a,b). ASCE 7 provides an alternative design method for RWFD structures in Section 12.10.4 where forces in the diaphragm may be reduced if special seismic detailing is provided for bare steel deck diaphragms. Further, for all other structures, the alternative diaphragm design provisions of ASCE 7 Section 12.10.3 also provide a means to reduce diaphragm forces when special seismic detailing is provided. The provisions of F3.5 are specifically intended to meet these special seismic detailing requirements.

Traditional equivalent lateral force (ELF)-based seismic design of bare steel deck diaphragms per ASCE 7 Section 12.10.1 allows diaphragm forces to be reduced based on the response modification factor, R , for the particular vertical seismic force resisting system, subject to minimum diaphragm force levels as defined in ASCE 7. The reduction in the diaphragm force levels is independent of the ductility or deformation capacity of the diaphragm. Analysis of a large scale RWFD archetype building under high demand with pre-cast tilt up walls and bare steel deck diaphragm roofs that either meet or violate the special seismic detailing requirements were completed by Schafer (2019). It was found that a mechanically fastened roof that met the special seismic detailing requirements of F3.5 had approximately $\frac{1}{2}$ the roof shear angle demands and $\frac{1}{2}$ the anchorage demands of an equivalent welded bare steel deck diaphragm roof that did not meet the special seismic detailing requirements. If the designer desires (for force reduction) or expects (due to the nature of the structure) inelastic demands in a bare steel deck diaphragm the special seismic detailing requirements provide a means to ensure ductility and deformation capacity in the diaphragm.

In addition to special seismic detailing, standard installation and construction procedures are necessary for successful performance. SDI (2017) provides QC/QA criteria for steel deck installation and SDI (2016) provides additional construction guidance. The QC/QA provisions include required special inspection for steel deck installation, both with and without special seismic detailing.

F3.5.1 Prescriptive Special Seismic Detailing

The prescriptive details for ductile performance of bare steel deck diaphragms were established through full-scale reversed cyclic cantilever diaphragm testing compiled and analyzed by O'Brien et al. (2017) and augmented with small-scale reversed cyclic connector tests by NBM (2017, 2018) and engineering judgment as summarized in Schafer (2019).

The assembled database of cantilever diaphragm tests focused on 36 in. wide 1.5 in. deep WR (also commonly known as B) deck. Deck profiles consistent with WR (wide rib) roof deck are defined by SDI (2016) as shown in Figure C-F3.5.1-1. Tests were conducted on 16 to 22 gauge deck. Adequate ductility was found across this range of deck thickness, but the contribution of the deck profile to the diaphragm ductility and the nature of the tilting/bearing mechanism at the structural and sidelap connections can change across this range of thickness. In general establishing the ductility and deformation capacity is more challenging in thicker gauge deck. The deck material should be ductile. A small sample of deck tested with low ductility sheet steel indicated reduced diaphragm ductility (Schafer 2019), as a result the deck is required to meet the material criteria established in AISI S100 Section A3.1.1.

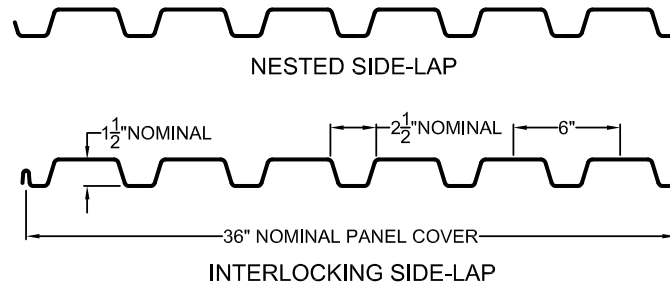

Figure C-F3.5.1-1 WR Deck Dimensions (see SDI 2016 for further details)

The structural connection between the deck and supporting member plays a crucial role in the performance of the bare steel deck diaphragm system, as this connection is required for shear transfer between the deck and the structural system. As detailed in Schafer (2019) PAF connections are shown to provide this connection with substantial ductility and deformation capacity. Although welds can provide adequate stiffness and strength, unless unique detailing is employed such as the weld with washer detail developed by Tremblay and Rogers (see e.g., Essa et al. 2003), they do not provide sufficient deformation capacity and ductility. As a result, the prescriptive requirements are limited to mechanical structural connections. The spacing requirements for structural connectors are based on the available tested configurations and engineering judgment. SDI (2015) provides further details on the thirty-six sevenths and thirty-six ninths attachment patterns as illustrated in Figure C-F3.5.1-2.

1.5" WR

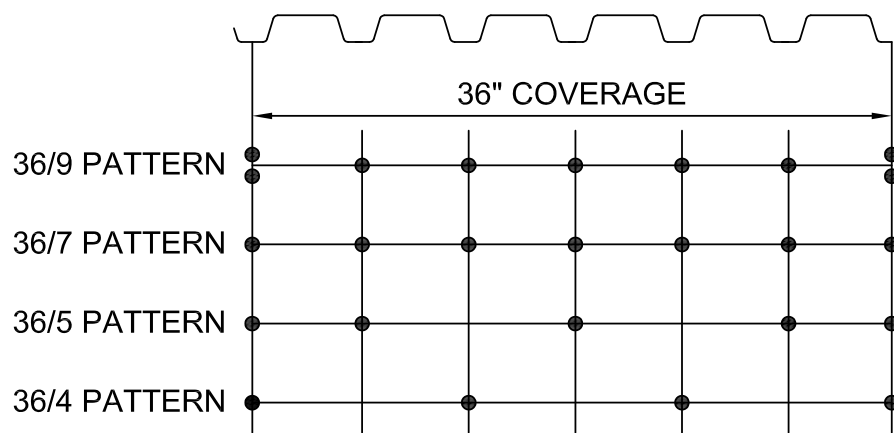

Figure C-F3.5.1-2 Typical Fastener Attachment Patters (see SDI 2015 for further details)

The sidelap connection, occurring from deck to deck, plays a crucial role in the stiffness of the diaphragm and also in determining how much of the diaphragm deformation is accommodated at the deck to deck connection or in the deck profile itself. Screwed sidelaps were shown to provide adequate performance so long as the screw is sized appropriately for the deck, specifically the limit state of the screw in shear, due to its brittle mode of failure, must be explicitly avoided for the connection to maintain a reasonable level of deformation capacity and ductility.

F3.5.1.1 Structural Connection Qualification

The Standard recognizes that a variety of structural connections may provide adequate stiffness, strength, ductility, and deformation capacity. To that end, this section provides the necessary criteria for establishing acceptable performance. However, this performance is within the context of the other limitations of Section

F3.5.1 and does not qualify a structural connection for use in any bare steel deck diaphragm, but rather its use as a component within the system defined in Section F3.5.1.

The structural connection is required to provide adequate mean performance in three reversed cyclic shear tests performed with deck specimens as defined in AISI S905. Tests must be performed for each connection configuration. In this context configuration refers to the different diaphragm configurations that may influence the performance of the connection. This standard consistent with AISI S310 defines configuration as “a specific arrangement of panel geometry, thickness, mechanical properties, span(s), and attachments”. At the connector level, the strength and ductility of the attachment itself is subject to the thickness of the supporting steel, as well as the panel properties listed above, including the thickness of the panels. As detailed further in Chapter E of AISI S310, this includes endlaps – which effectively doubles the thickness of the panels, and can potentially impact the performance of the structural connection. The ductility and deformation targets provided are based on connector testing, diaphragm testing, and diaphragm and building modeling as summarized in Schafer (2019).

F3.5.1.2 Sidelap Connection Qualification

Qualification of sidelap connections largely parallels that of structural connections. However, the Standard provides direct guidance on the use of screwed sidelaps, and provides the provisions of this section for qualification of other sidelap configurations. Top arc seam welded and traditional button punched sidelaps have not been shown to provide adequate performance compared with these provisions, as summarized in Schafer (2019).

F3.5.2 Performance-Based Special Seismic Detailing

This Standard provides two paths for the qualification of bare steel deck diaphragms that fall outside the prescriptive requirements of F3.5.1: cantilever diaphragm testing, or computational modeling. The diaphragm testing can be understood as an extension of AISI S310 Chapter E, which provides detailed provisions for stiffness and strength determination by testing. The computational modeling can be understood as an extension of AISI S310 F1.4 which establishes that principles of mechanics may typically be used for determining shear strength.

F3.5.2.1 Special Seismic Qualification by Cantilever Diaphragm Test

The special seismic detailing requirements of F3.5.1 define the parameters that led to cantilever diaphragm tests that provided adequate levels of ductility and deformation capacity, as summarized in Schafer (2019). The provisions of this section define the performance level that was deemed adequate from that testing. Given the large degradation found between monotonic performance and reversed cyclic performance, reversed cyclic tests are required. Rather than requiring 3 reversed cyclic tests for each separate diaphragm configuration the provisions give some latitude to distribute the testing across each specific range of a given diaphragm configuration, while still requiring repeated tests at the boundaries of the selected range. Care should be taken to ensure that the tests are planned to cover the boundary conditions where non-ductile or limited deformation capacity is most likely. Regardless, the ductility, deformation capacity, and residual force capacity performance targets must be met, and documented.

ASCE 7 Section 1.3.1.3 defines the broad application of performance-based procedures in design including: analysis, testing, documentation, and peer review. For purposes of Section F3.5.2.1, only the peer review provisions of ASCE 7 Section 1.3.1.3.4 are required, with allowance for review by a third party acceptable to the Authority Having Jurisdiction as an alternate. This is because the provisions of Section F3.5.2.1 provide a specific test-based application of performance-based design for bare steel deck diaphragms; where the performance objectives and testing method are explicitly defined. Documentation of the testing and review must be provided to the Authority Having Jurisdiction.

F3.5.2.2 Special Seismic Qualification by Principles of Mechanics

AISI standards typically provide pathways for rational engineering analysis methods in the determination of stiffness and strength of components (e.g. see AISI S100 A1.2(b) and (c), AISI S400 F1.4). This section expands that scope to the prediction of ductility and deformation capacity, as would be needed to establish that a bare steel deck diaphragm meets a desired level of energy dissipation. Essentially, the provisions state that if done with care a computational model can replace the cantilever diaphragm test. An example of such a model is provided in Schafer (2019).

An appropriately implemented material and geometric nonlinear shell finite element model can capture the nonlinear behavior of a steel deck including buckling and yielding. However, the friction, bearing, and fracture which is common at the structural and sidelap connections under cyclic demands can be challenging to explicitly capture in such a model. Schafer (2019) employed testing of these connections and used the hysteretic response from these tests in a phenomenological-based spring at every structural and sidelap connection. This approach provides a pathway to directly explore the impact of connections on bare steel deck diaphragms that are outside the prescriptive scope of F3.5.1 without performing costly cantilever diaphragm tests. This also provides a means to plan such diaphragm testing with greater precision and reduced cost.

Application of the provisions of this section require a reasonably high level of technical sophistication. In addition to the requirements of this section, ASCE 7 Section 1.3.1.3 provides additional useful guidance on the application of analysis and testing towards establishing performance. For purposes of Section F3.5.2.1, only the peer review provisions of ASCE 7 Section 1.3.1.3.4 are required, with allowance for review by a third party acceptable to the Authority Having Jurisdiction as an alternate. Documentation must be provided to the Authority Having Jurisdiction and should include either peer review, or third party review most likely through an evaluation report. Development of evaluation criteria consistent with the provisions of this section is expected in the future.

C14.1.7 Steel Cables.

These provisions reference ASCE 19, *Structural Applications of Steel Cables for Buildings*, for the determination of the design strength of steel cables.

C14.1.8 Additional Detailing Requirements for Steel Piles in Seismic Design Categories D through F.

Steel piles used in higher SDCs are expected to yield just under the pile cap or foundation because of combined bending and axial load. Design and detailing requirements of AISC 341 for H-piles are intended to produce stable plastic hinge formation in the piles. Because piles can be subjected to tension caused by overturning moment, mechanical means to transfer such tension must be designed for the required tension force, but not less than 10% of the pile compression capacity.

C14.2 CONCRETE

The section adopts by reference ACI 318 for structural concrete design and construction. In addition, modifications to ACI 318-14 are made that are needed to coordinate the provisions of that material design standard with the provisions of ASCE 7. Work is ongoing to better coordinate the provisions of the two documents (ACI 318 and ASCE 7) such that the provisions in Section 14.2 will be progressively reduced in future editions of ASCE 7.

C14.2.2.1 Definitions.

Two definitions included here describe wall types for which definitions currently do not exist in ACI 318. These definitions are essential to the proper interpretation of the R and C_d factors for each wall type specified in Table 12.2-1.

A definition for *connector* has been added, which does not currently exist in ACI 318-14. Section 12.11 provides an alternative to the current diaphragm design procedure of Section 12.10. The alternative procedure is made mandatory for precast concrete diaphragms in structures assigned to SDC C, D, E, or F. The definition of *connector* is essential because the three design options (BDO, EDO, and RDO) are closely related to the connector classification, and the diaphragm design force reduction factor, R_s , depends on the design option.

The definition for *connection* in ACI 318-14 has also been supplemented, as it applies to this protocol.

C14.2.2.2 ACI 318, Section 10.7.6.

ACI 318-14, Section 10.7.6.1.6, prescribes details of transverse reinforcement around anchor bolts in the top of a column or pedestal. This modification prescribes additional details for transverse reinforcement around such anchor bolts in structures assigned to SDCs C through F.

C14.2.2.3 Scope.

This provision describes how the ACI 318-14 provisions should be interpreted for consistency with the ASCE 7 provisions.

C14.2.2.4 Intermediate Precast Structural Walls.

Section 18.5 of ACI 318-14 imposes requirements on precast walls for moderate seismic risk applications. Ductile behavior is to be ensured by yielding of the steel elements or reinforcement between panels or between panels and foundations. This provision requires the designer to determine the deformation in the connection corresponding to the earthquake design displacement and then to check from experimental data that the connection type used can accommodate that deformation without significant strength degradation.

Several steel element connections have been tested under simulated seismic loading, and the adequacy of their load-deformation characteristics and strain capacity have been demonstrated (Schultz and Magana 1996). One such connection was used in the five-story building test that was part of the Precast Seismic Structural Systems (PRESSSS) Phase 3 research. The connection was used to provide damping and energy dissipation, and it demonstrated a very large strain capacity (Nakaki et al. 2001). Since then, several other steel element connections have been developed that can achieve similar results (Banks and Stanton 2005 and Nakaki et al. 2005). In view of these results, it is appropriate to allow yielding in steel elements that have been shown experimentally to have adequate strain capacity to maintain at least 80% of their yield force through the full design displacement of the structure.

C14.2.2.6 Foundations.

The intention is that there should be no conflicts between the provisions of ACI 318-14, Section 18.13, and ASCE 7, Sections 12.1.5, 12.13, and 14.2. However, the additional detailing requirements for concrete piles of Section 14.2.3 can result in conflicts with ACI 318-14 provisions if the pile is not fully embedded in the soil.

C14.2.2.7 Detailed Plain Concrete Shear Walls.

Design requirements for plain masonry walls have existed for many years, and the corresponding type of concrete construction is the plain concrete wall. To allow the use of such walls as the lateral force-resisting system in SDCs A and B, this provision requires such walls to contain at least the minimal reinforcement specified in ACI 318-14, Section 14.6.2.2.

C14.2.3 Additional Detailing Requirements for Concrete Piles.

Chapter 20 of PCI (2004) provides detailed information on the structural design of piles and on pile-to-cap connections for precast prestressed concrete piles. ACI 318-14 does not contain provisions governing the

design and installation of portions of concrete piles, drilled piers, and caissons embedded in ground except for SDC D, E, and F structures.

C14.2.3.1.2 Reinforcement for Uncased Concrete Piles (SDC C).

The transverse reinforcing requirements in the potential plastic hinge zones of uncased concrete piles in SDC C are a selective composite of two ACI 318-14 requirements. In the potential plastic hinge region of an intermediate moment-resisting concrete frame column, the transverse reinforcement spacing is restricted to the least of (1) eight times the diameter of the smallest longitudinal bar, (2) 24 times the diameter of the tie bar, (3) one-half the smallest cross-sectional dimension of the column, and (4) 12 in. (304.8 mm). Outside of the potential plastic hinge region of a special moment-resisting frame column, the transverse reinforcement spacing is restricted to the smaller of six times the diameter of the longitudinal column bars and 6 in. (152.4 mm).

C14.2.3.1.5 Reinforcement for Precast Nonprestressed Piles (SDC C).

Transverse reinforcement requirements inside and outside of the plastic hinge zone of precast nonprestressed piles are clarified. The transverse reinforcement requirement in the potential plastic hinge zone is a composite of two ACI 318-14 requirements (see Section C14.2.3.1.2). Outside of the potential plastic hinge region, the transverse reinforcement spacing is restricted to 16 times the longitudinal bar diameter. This restriction should permit the longitudinal bars to reach compression yield before buckling. The maximum 8-in. (203.2-mm) tie spacing comes from current building code provisions for precast concrete piles.

C14.2.3.1.6 Reinforcement for Precast Prestressed Piles (SDC C).

The transverse and longitudinal reinforcing requirements given in ACI 318-14, Chapter 21, were never intended for slender precast prestressed concrete elements and result in unbuildable piles. These requirements are based on PCI Committee on Prestressed Concrete Piling (1993).

Eq. (14.2-1), originally from ACI 318-14, has always been intended to be a lower bound spiral reinforcement ratio for larger diameter columns. It is independent of the member section properties and can therefore be applied to large- or small-diameter piles. For cast-in-place concrete piles and precast prestressed concrete piles, the spiral reinforcing ratios resulting from this formula are considered to be sufficient to provide moderate ductility capacities (Fanous et al. 2007).

Full confinement per Eq. (14.2-1) is required for the upper 20 ft (6.1 m) of the pile length where curvatures are large. The amount is relaxed by 50% outside of that length in view of lower curvatures and in consideration of confinement provided by the soil.

C14.2.3.2.3 Reinforcement for Uncased Concrete Piles (SDC D through F).

The reinforcement requirements for uncased concrete piles are taken from current building code requirements and are intended to provide ductility in the potential plastic hinge zones (Fanous et al. 2007).

C14.2.3.2.5 Reinforcement for Precast Nonprestressed Piles (SDC D through F).

The transverse reinforcement requirements for precast nonprestressed concrete piles are taken from the IBC (ICC 2012) requirements and should be adequate to provide ductility in the potential plastic hinge zones (Fanous et al. 2007).

C14.2.3.2.6 Reinforcement for Precast Prestressed Piles (SDC D through F).

The reduced amounts of transverse reinforcement specified in this provision compared with those required for special moment frame columns in ACI 318-14 are justified by the results of the study by Fanous et al.

(2007). The last paragraph provides minimum transverse reinforcement outside of the zone of prescribed ductile reinforcing.

C14.2.4 Additional Design and Detailing Requirements for Precast Concrete Diaphragms.

Section 12.10.3 introduces an alternative procedure for the calculation of diaphragm design forces of Sections 12.10.1 and 12.10.2 and is made mandatory for precast concrete diaphragms in structures assigned to SDC C, D, E, or F. The diaphragm design force reduction factors, R_s , in Table 12.10-1 for precast concrete diaphragms are specifically tied to design and detailing requirements so that the ductility and overstrength necessary for expected diaphragm performance are achieved. Section 14.2.4 is based on the Diaphragm Seismic Design Methodology (DSDM), the product of a multiple-university research project termed the DSDM Project (Charles Pankow Foundation 2014), and gives detailing requirements for diaphragms constructed of precast concrete units in SDC C, D, E, or F consistent with the R_s factors. These detailing requirements are in addition to those of ACI 318, as modified by Section 14.2. The derivation of diaphragm design force reduction factors is described in Commentary Section C12.10.3.5.

Section C12.10.3.5 relates the global ductility required by the three design options defined in Section 11.2 to the local ductility of connectors measured at the maximum considered earthquake (MCE) level. The jointed nature of precast systems results in the load paths and deformations being largely determined by the connections across the joints. The connections may consist of either reinforced concrete topping slabs or discrete mechanical connectors. Since the diaphragm strains are concentrated at the joints, the connectors or the reinforcing in the topping slab must accommodate some strain demand.

C14.2.4.1 Diaphragm Seismic Demand Levels.

Figure 14.2-1 is used to determine diaphragm seismic demand level as a function of the diaphragm span and the diaphragm aspect ratio.

The diaphragm span defined in Section 14.2.4.1.1 is illustrated in Figure C14.2-1. Most precast diaphragms contain precast units running in only one direction, and typically the maximum span is oriented perpendicular to the joints between the primary precast floor units. The connector or reinforcement deformability classifications and resulting R_s factors are calibrated relative to joint openings between the precast floor units and are thus based on the more typical orientation.

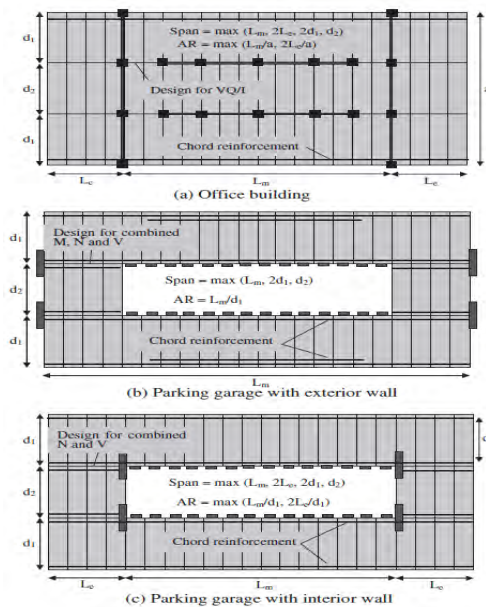

FIGURE C14.2-1 Diaphragm Dimensions

The diaphragm aspect ratio (AR) defined in Section 14.2.4.1.2 is also illustrated in Figure C14.2-1.

The following lists provide details of seismic demand level classifications, determined in accordance with Figure 14.2-1:

Low Seismic Demand Level

1. Diaphragms in structures assigned to SDC C.
2. Diaphragms in structures assigned to SDC D, E, or F with diaphragm span ≤ 75 ft (22.86 m), number of stories ≤ 3 , and diaphragm aspect ratio < 2.5 .

Moderate Seismic Demand Level

1. Diaphragms in structures assigned to SDC D, E, or F with diaphragm span ≤ 75 ft (22.86 m) and number of stories > 3 but ≤ 6 .
2. Diaphragms in structures assigned to SDC D, E, or F with diaphragm span > 75 ft (22.86 m) but ≤ 190 ft (57.91 m) and number of stories ≤ 2 .
3. Diaphragms in structures assigned to SDC D, E, or F with diaphragm span > 75 ft (22.86 m) but ≤ 140 ft (42.67 m) and number of stories > 2 but ≤ 4 .
4. Diaphragms in structures assigned to SDC D, E, or F with diaphragm span ≤ 75 ft (22.86 m), number of stories ≤ 3 , and diaphragm aspect ratio ≥ 2.5 .
5. Diaphragms in structures assigned to SDC D, E, or F, categorized below as high seismic demand level, with diaphragm aspect ratio < 1.5 .

High Seismic Demand Level

1. Diaphragms in structures assigned to SDC D, E, or F with diaphragm span > 190 ft (57.91 m).
2. Diaphragms in structures assigned to SDC D, E, or F with diaphragm span > 140 ft (42.67 m) and number of stories > 2 .
3. Diaphragms in structures assigned to SDC D, E, or F with diaphragm span > 75 ft (22.86 m) and number of stories > 4 .
4. Diaphragms in structures assigned to SDC D, E, or F with number of stories > 6 .

Diaphragm Shear Overstrength Factor. The diaphragm shear overstrength factor, Ω_v , is applied to diaphragm shear reinforcement/connectors. The purpose of this factor is to keep the diaphragm shear response elastic while the diaphragm develops inelastic flexural action, as is anticipated for the basic design objective (BDO) in the MCE, and for the reduced design objective (RDO) for both the design earthquake and the MCE. No inelastic diaphragm response is anticipated for the elastic design objective (EDO).

The value of diaphragm shear overstrength factor is $\Omega_v = 1.4R_s$. The values of the diaphragm design force reduction factor, R_s , are 0.7, 1.0, and 1.4 for the EDO, BDO, and RDO, respectively. This value translates into diaphragm shear overstrength factors Ω_v of 1.0, 1.4, and 2.0 (rounded to one decimal place) for the EDO, BDO, and RDO, respectively.

The diaphragm shear overstrength factor, Ω_v , is applied to the diaphragm design forces and thus is a measure relative to the flexural strength of the diaphragm. As implied by the above-listed Ω_v values, the level of overstrength required relative to the diaphragm flexural strength varies with the design option. The RDO requires a higher overstrength than the BDO because of the larger anticipated inelastic action. For the EDO, no overstrength is required since the diaphragm design force itself targets elastic behavior in the MCE. It is noted that the absolute shear strength required in the design procedure is constant, regardless of design

option, since the parameter R_s in the overstrength factor is canceled out by the R_s in the denominator of the diaphragm design force expression.

The Ω_v values represent upper bound constant values (for each diaphragm design objective) of parametric expressions developed for the required shear overstrength on the basis of detailed parametric studies performed using nonlinear dynamic time history analysis (NTHA) of analytical models of precast structures developed and calibrated on the basis of extensive large-scale physical testing. These precast structures were subjected to spectrum compatible ground motions scaled to the MCE in order to determine the required shear overstrength factors.

Precast diaphragms can be designed and detailed for ductile flexural response. However, to achieve the desired mechanism, potentially nonductile shear limit states have to be precluded. In order to prevent these shear failures, elastic shear response is targeted in the design procedure for both flexure-controlled and shear-controlled systems. Thus, the shear overstrength factor, Ω_v , is applied in diaphragm shear design.

The shear amplification factor values were obtained by bounding the maximum shear force V_{\max} occurring in NTHA of the diaphragm at the critical shear joint as the diaphragm developed a flexural mechanism (in other regions of the floor) at MCE-level hazard and scaling it by the design shear, V_u . Accordingly:

- Ω_E , the diaphragm shear amplification factor for the EDO, is taken as unity ($\Omega_E = 1.0 \approx 1.4R_s$, where $R_s = 0.7$ for EDO) since elastic diaphragm response is expected in the MCE for EDO.
- Ω_B , the diaphragm shear amplification factor for the BDO, is taken as an upper bound on the V_{\max}/V_u ratio for the BDO design under MCE-level hazard.
- Ω_R , the diaphragm shear amplification factor for the RDO, is taken as an upper bound on the V_{\max}/V_u ratio for the RDO design under MCE-level hazard.

Figure C14.2-2 shows a scatter plot of the V_{\max}/V_u ratios from NTHA for different numbers of stories (n) and diaphragm aspect ratios (ARs) at the maximum considered earthquake. The data represent the mean of the maximum responses from five ground motions. The expression provided for Ω_v , $= 1.4R_s$, is plotted as a horizontal dashed line on each plot, indicating that the expression provides a constant upper bound for the anticipated required elastic shear forces for all design cases.

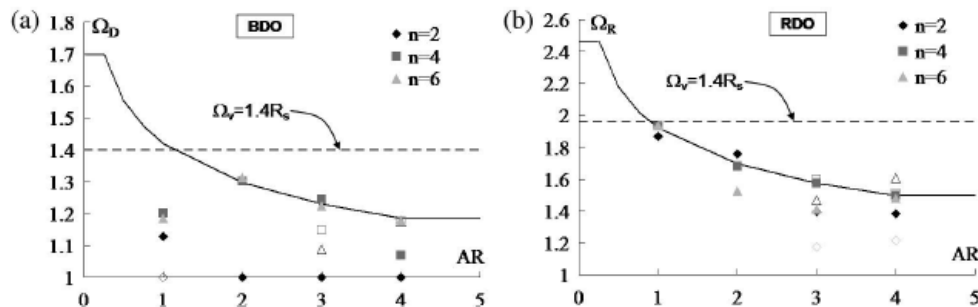

FIGURE C14.2-2 Diaphragm Shear Amplification Factor Results from NTHA at MCE: (a) BDO; (b) RDO

C14.2.4.2 Diaphragm Design Options.

The intent of the design procedure is to provide the diaphragm with the proper combination of strength and deformation capacity in order to survive anticipated seismic events. Three different design options are

provided to the designer to accomplish this objective, ranging from a fully elastic diaphragm design under the MCE to designs that permit significant inelastic deformations in the diaphragm under the design earthquake. The motivation for this approach is the recognition that, under certain conditions, a precast diaphragm designed to remain fully elastic up to the MCE may not be economical or reliable. Under other conditions, however, a diaphragm designed to remain elastic up to the MCE will be satisfactory and may be most desirable.

The methodology allows the designer three options related to deformation capacity:

1. An elastic design option (EDO), where the diaphragm is designed to the highest force levels, is calibrated to keep the diaphragm elastic not only for the design earthquake but also in an MCE. In exchange for the higher design force, this option permits the designer to detail the diaphragm with the low deformability element (LDE) connector or reinforcement that need not meet any specific deformation capacity requirements (tension deformation capacity less than 0.3 in. (7.6 mm)). This option is limited in its use through the introduction of diaphragm seismic demand levels, which are based on building height, diaphragm geometry, and seismic hazard level. The use of the EDO is not permitted if the diaphragm seismic demand level is high.
2. A basic design objective (BDO) is one in which the diaphragm is designed to a force level calibrated to keep the diaphragm elastic in the design earthquake but not necessarily in the MCE. The design force level is lower than that required for the EDO, but this option requires moderate deformability element (MDE) connectors or reinforcement or better to provide an inelastic deformation capacity sufficient to survive the anticipated deformation demands in an MCE. This option and the RDO require the use of a diaphragm shear overstrength factor, Ω_0 , to ensure that a nonductile shear failure does not occur before the connectors or reinforcement reaches its intended inelastic deformation. Note that *inelastic deformation* is associated with joint *opening* caused by diaphragm flexure, not joint sliding deformation caused by shear.
3. A reduced design option (RDO) is one in which the diaphragm is designed for the lowest design force level.

Because the design force level is lower than in the BDO, some yielding in the diaphragm is anticipated in the design earthquake. The force levels have been calibrated to keep diaphragm inelastic deformation demands in an MCE within the allowable deformation capacity for the high deformability element (HDE), the highest classification of precast diaphragm connector or reinforcement (see Section 14.2.4.3).

Each design option can be used with its associated seismic demand level or a lower seismic demand level. A 15% diaphragm force increase penalty is applied when a diaphragm design option is used for a seismic demand level that is one higher than its associated seismic demand level. A design option cannot be used for a seismic demand level two higher than the associated seismic demand level, i.e., the elastic design option cannot be used for the high seismic demand level.

The BDO has two performance targets: (1) elastic diaphragm response in the design earthquake, and (2) diaphragm connector/reinforcement deformation demands (i.e., joint opening) in the MCE within the allowable deformation capacity of connector/reinforcement in the moderate deformability element (MDE) category, δ_a^{MD} . The diaphragm design force levels for the BDO are aligned to the former requirement.

Thus, the attainment of the second performance target hinges on the selection of the value for δ_a^{MD} relative to the diaphragm inelastic deformation demands anticipated for the maximum considered earthquake. These anticipated deformation demands were established through nonlinear dynamic time history analysis (NTHA) of precast structures with diaphragms designed to the BDO force levels and subjected to spectrum compatible ground motions scaled to the MCE.

It should be recognized that practical considerations also exist in the selection of δ_a^{MD} . The allowable deformation of high deformability elements (HDEs), δ_a^{HD} , (as required for the RDO) was established based

on the best performing existing precast diaphragm connectors. This performance resulted in an HDE allowable deformation capacity $\delta_a^{\text{HD}} = 0.4$ in. ($\delta_a^{\text{HD}} = 10.2$ mm). (Note that the allowable value is 2/3 of the qualification value, thus HDEs are required to have a demonstrated deformation capacity of 0.6 in. (15.2 mm) in qualification testing, as was achieved by the best performing existing connectors). Given that low deformability elements (LDEs) do not have a deformation requirement, the MDE allowable deformation value should reside somewhere near half the HDE value, or $\delta_a^{\text{MD}} = 0.2$ in. ($\delta_a^{\text{MD}} = 5.1$ mm).

The NTHA results for the MCE are shown in Figure C14.2-3. These results show that $\delta_a^{\text{MD}} = 0.2$ in. ($\delta_a^{\text{MD}} = 5.1$ mm) was an appropriate and viable choice for the MDEs used in the BDO, provided that the diaphragms were in the moderate seismic demand level (solid triangles in Figure C14.2-3) or in the low seismic demand level (solid circles in Figure C14.2-3). However, this value did not produce satisfactory designs for diaphragms in the high seismic demand level (solid squares in Figure C14.2-3), and thus some measure is required to bring the design procedure in conformance.

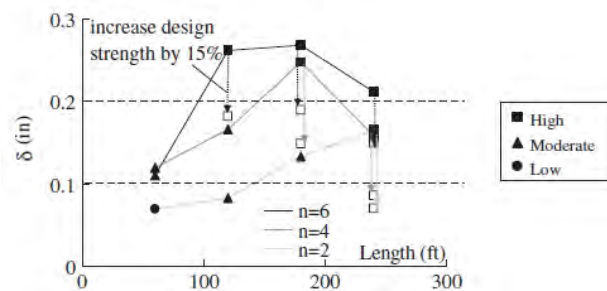

FIGURE C14.2-3 Diaphragm Maximum Joint Opening in NTHA for Basic Design Objective Designs under the MCE

A choice exists in how to modify the design procedure to resolve this nonconformance to the design target: (a) The allowable deformation ranges for the diaphragm connectors/reinforcement could be modified (i.e., a more stringent qualification deformation requirement for MDE, leading to an increase in δ_a^{MD}); (b) the diaphragm force levels could be increased across the board (i.e., change the design earthquake performance target for elastic diaphragm response from the diaphragm yield point itself to a lower value within the diaphragm elastic range); or (c) create a special requirement for the nonconforming diaphragm case (i.e., increase the diaphragm forces only for nonconforming cases). The first choice did not align well with the typical deformation capacities of existing connectors and would not produce evenly sized deformation ranges for the LDE, MDE, and HDE classifications. The second choice not only produces overly conservative designs for many cases, but it also blurs the clean BDO performance target of elastic diaphragm response in the design earthquake. For these reasons, the third choice was considered the most desirable.

Thus, rather than increase the value of δ_a^{MD} to accommodate the diaphragms in the high seismic demand level, it was decided to keep $\delta_a^{\text{MD}} = 0.2$ in. ($\delta_a^{\text{MD}} = 5.1$ mm) and create a special requirement for conformance in the case of diaphragms in the high seismic demand level. As each design option was developed with an associated diaphragm seismic demand level in mind, and the nonconformance did not occur at the associated level, i.e., the moderate seismic demand level, but instead at the high seismic demand level, the special requirement can be considered a measure for using a diaphragm design option with a more demanding seismic demand level.

The special requirement is an increase in the design force for the nonconforming case. The magnitude of the design force increase is 15%. The manner in which this value was established is also shown in Figure C14.2-3. As mentioned previously, the solid squares indicate the maximum diaphragm

connector/reinforcement deformation (joint opening demand) for the BDO for high diaphragm seismic demand levels and indicate demands greater than $\delta_a^{MD} = 0.2$ in. (5.1 mm). The open squares indicate the maximum diaphragm connector/reinforcement deformation for these same cases with the 15% increase in diaphragm force. This design force increase is seen to bring the deformation demand within the allowable limit. The same design force increase is enforced in Section 14.2.4.2.1 for use of the EDO with the moderate seismic demand level, though this provision was not based on any quantitative analytical results.

C14.2.4.3 Diaphragm Connector or Joint Reinforcement Deformability.

The precast diaphragm seismic design methodology (DSDM) uses an approach that requires knowledge of the diaphragm connector or reinforcement stiffness, deformation capacity, and strength to effectively and efficiently design the diaphragm system for seismic forces. To meet this need, it is critical that the connector or reinforcement properties be determined in a repeatable, reproducible, and consistent manner so that existing and new connections can be used effectively in the diaphragm system. The qualification protocol provides an experimental approach for the determination of connector or reinforcement properties.

Precast concrete diaphragms deform mostly by the strains that occur at the joints between the precast concrete units. The requirements for reinforcement or connector deformability come from the need for the connections to accommodate these strains at the joints. A connection is an assembly of connectors, including the linking parts, welds, and anchorage to concrete. Mechanical connectors are identified as the primary parts that make the connection, but the deformation capacity identified with the connector represents the performance of the entire link across the joint. Qualification of the deformation capacity of the connector, then, is dependent on the details of the entire load path across the joint. The use in design of a connector qualified by testing is only valid when the design incorporates the complete connector detailing, as tested.

The diaphragm reinforcement classifications are high deformability elements (HDEs), moderate deformability elements (MDEs), and low deformability elements (LDEs). The threshold values of tension deformation capacity for each connector or reinforcement class were selected by considering the range of the ultimate (cyclic tension opening) deformations exhibited by the various precast diaphragm connectors examined in the DSDM experimental program (Naito et al. 2006, 2007). Based on these results, a threshold deformation of 0.6 in. (15.2 mm) was selected for HDE connector or reinforcement and 0.3 in. (7.6 mm) for MDE connector or reinforcement. There is no deformation requirement for LDE reinforcement.

A factor of safety of 1.5 was introduced into the design procedure by establishing the allowable maximum joint opening value at $2/3$ of the connector's reliable and maximum joint opening deformation capacity. The $2/3$ factor leads to maximum allowable deformations of 0.4 in. (10.2 mm) and 0.2 in. (5.1 mm) for the high deformability element (HDE) and the moderate deformability element (MDE), respectively. No deformation capacity requirement is needed for the low deformability element (LDE), since this classification of connector or reinforcement is used with designs that result in fully elastic diaphragm response up to the MCE. The allowable maximum joint openings were used as targets in the analytical parametric studies to calibrate the design factors.

A few further comments are given about the connector or reinforcement classification:

1. The diaphragm connector or reinforcement classification is based on inelastic deformation associated with joint opening caused by diaphragm flexure, not joint sliding deformation caused by shear.
2. The diaphragm connector or reinforcement classification applies to the chord reinforcement and shear reinforcement. Other reinforcement (collector/anchorage, secondary connections to spandrels, and similar items) may have different requirements or characteristics.
3. In meeting the required maximum deformation capacity using the testing protocols in the qualification procedure, the required cumulative inelastic deformation capacity is also met.

C14.2.4.3.5 Deformed Bar Reinforcement.

Deformed bar reinforcement can be considered to be high deformability elements (HDEs), provided that certain conditions are met.

C14.2.4.3.6 Special Inspection.

The purpose of this requirement is to verify that the detailing required in HDEs is properly executed through inspection personnel who are qualified to inspect these elements. Qualifications of inspectors should be acceptable to the jurisdiction enforcing the general building code.

C14.2.4.4 Precast Concrete Diaphragm Connector and Joint Reinforcement Qualification Procedure.

This section provides a qualification procedure using experimental methods to assess the in-plane strength, stiffness, and deformation capacity of precast concrete diaphragm connectors and reinforcement. The methodology was developed as part of the DSDM research program specifically for diaphragm flange-to-flange connections and is intended to provide the required connector or reinforcement properties and classification for use in the seismic design procedure.

C14.2.4.4.1 Test Modules.

Test modules are fabricated and tested to evaluate the performance of a precast concrete connection. Figure C14.2-4 illustrates an example test module. It is required that multiple tests be conducted to assess repeatability and consistency. The test module should represent the geometry and thickness of the precast concrete components that will be connected. All connectors and reinforcement should be installed and welded in accordance with the manufacturer's published installation instructions. The results or the data generated are limited to connections built to the specified requirements.

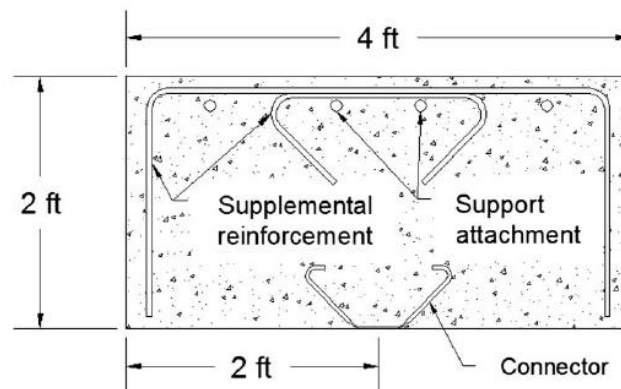

FIGURE C14.2-4 Test Module

Reduced scale connectors with appropriate reductions in maximum aggregate size following laws of similitude can be used as research tools to gain knowledge but are not to be used for connector qualification.

C14.2.4.4.3 Test Configuration.

A possible setup is illustrated in Figure C14.2-5. Three independently controlled actuators are used, two providing axial displacement and one providing shear displacement to the connection.

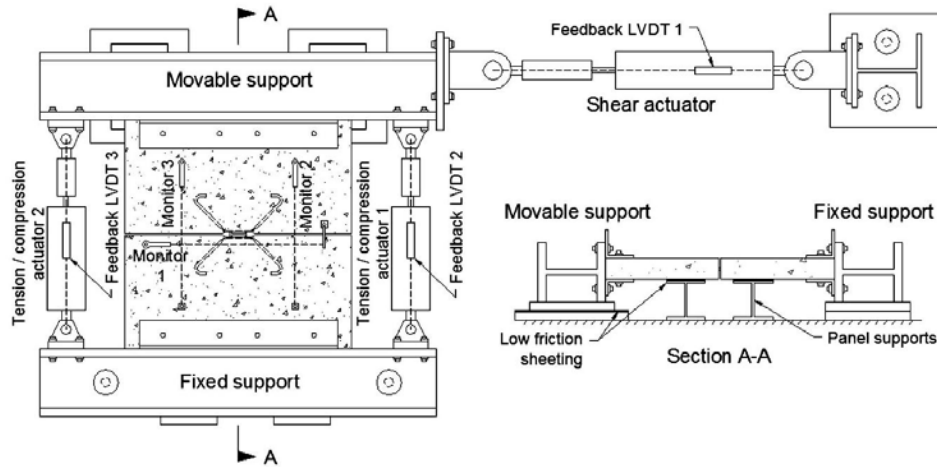

FIGURE C14.2-5 Possible Test Setup

C14.2.4.4.4 Instrumentation.

Use of actuator transducers is not recommended because of potential slip in the test fixture.

C14.2.4.4.5 Loading Protocols.

Figs. C14.2-6 and C14.2-7 illustrate the shear and tension/compression loading protocols for use in testing.

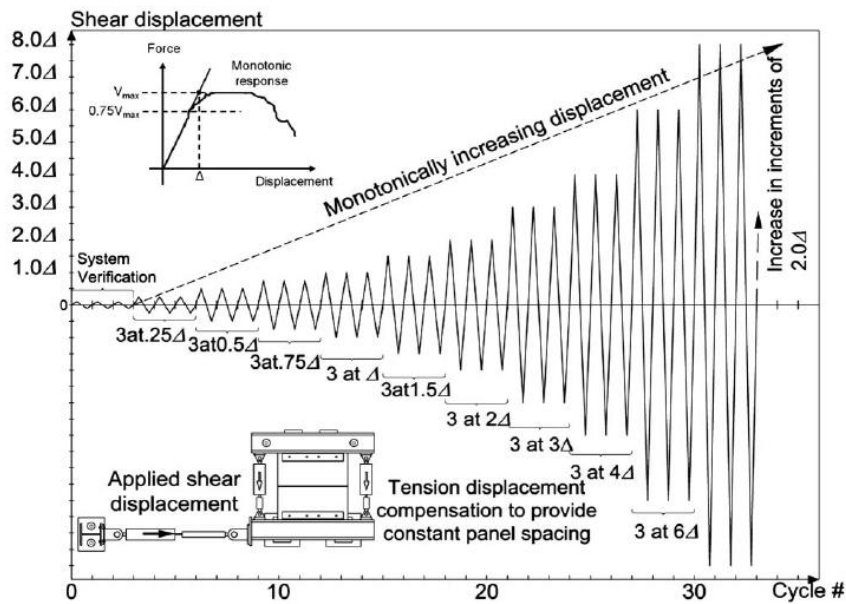

FIGURE C14.2-6 Shear Loading Protocol

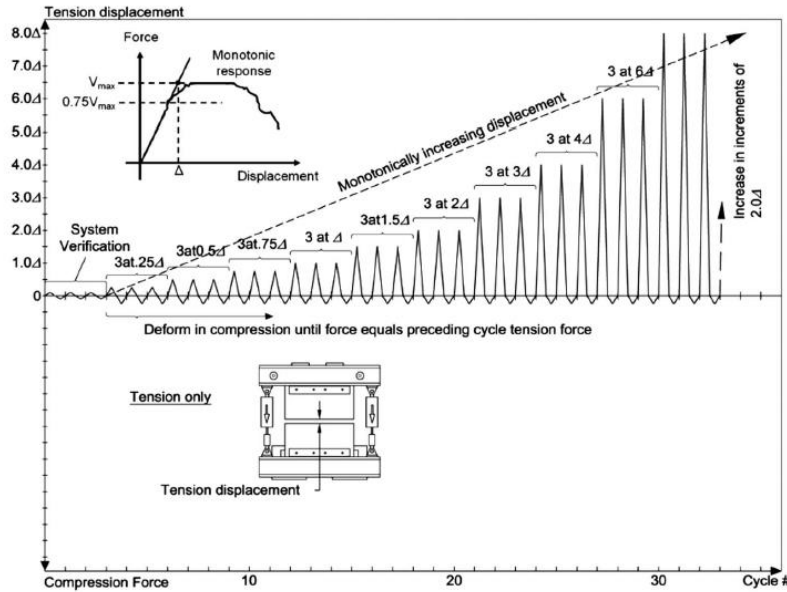

FIGURE C14.2-7 Tension/Compression Loading Protocol

C14.2.4.4.6 Measurement Indices, Test Observations, and Acquisition of Data

Quantitative data should be recorded from each test, such that interpretation can be made of the performance of the test module. For in-plane tests, the axial and shear force and deformations should be recorded. Photographs should be taken to illustrate the condition of the test module at the initiation and completion of testing as well as at points through the testing history. Ideally, photos should be taken at the end of each group of cycles. Test history photos taken at points of interest, such as cracking, yielding, and peak load, and post test photos are adequate for most evaluations.

The backbone curve is adopted to represent a simple approximation of the load-deformation response of the connection. The points are defined in terms of the resistances P_a , P_1 , P_b , P_2 , P_{2a} , and P_3 , and the displacements Δ_a , Δ_1 , Δ_b , Δ_2 , Δ_{2a} , and Δ_3 , respectively.

As depicted in Figure 14.2-3, the Type 1 curve is representative of ductile behavior where there is an elastic range (Point 0 to Point 1 on the curve) and an inelastic range (Point 1 to Point 3 on the curve), followed by loss of force-resisting capacity. The Type 2 curve is representative of ductile behavior where there is an elastic range (Point 0 to Point 1) and an inelastic range (Point 1 to Point 2 on the curve), followed by substantial loss of force-resisting capacity. Some connections may exhibit a small peak strength with limited ductility. For these cases, the Alternate Type 2 curve is recommended. The Type 3 curve is representative of a brittle or nonductile behavior where there is an elastic range (Point 0 to Point 1) followed by loss of strength. Deformation-controlled elements conform to Type 1 or Type 2, but not Type 2 Alternate, response with $\Delta_2 \geq 2\Delta_1$. All other responses are classified as force-controlled. An example of test data is included in Ren and Naito (2013).

C14.2.4.4.7 Response Properties.

The reliable and stable maximum deformation capacity is defined for design code purposes as the connector deformation at peak load, Point 2 on the backbone curve, obtained in testing following the loading protocols defined here. All analytical calibrations were performed for a reliable and stable maximum deformation capacity corresponding to a deformation where the strength reduces to 80% of P_2 , which is similar to the

beam–column connection deformation capacity definition for steel structures in AISC 341. Thus, an added degree of conservatism is provided in the definition proposed for the design code.

Deformation Category. The category ranges were determined from finite element analysis of a database of diaphragm systems under a range of seismic demands. Alternate deformation limits can be used if supporting data are provided. It should be noted that the connector or joint reinforcement classification is based solely on *tension* deformation capacity (as stated in Section 14.2.4.3), whereas the qualification procedure applies equally to, and requires, both tension and shear tests. In other words, while both tension and shear characterization are required to determine the needed strengths, the connector classification is based solely on the tension testing.

Tensile Strength. The design factors for flexural strength are calibrated to the yield point of the chord connectors, not to their peak strength. For instance, for the EDO, elastic response of the diaphragm under the MCE is being targeted, so this response is aligned to the yield strength, not the peak strength. For consistency, the BDO and RDO factors are also calibrated to this same level, i.e., yield. So the nominal strength of the connectors is based on P_1 , not P_2 . Using P_2 creates a situation where yield should be anticipated in the diaphragm for the EDO, and larger inelastic deformations for the BDO and RDO.

Shear Strength. The intention is for the diaphragm system to remain elastic under shear demands. Consequently, the inelastic shear force capacity of connections is not considered. Because of the existence of low stiffness connections, limits are placed on the allowable deformation at which the force P_1 can be determined.

C14.2.4.4.8 Test Report.

The minimum information that must be included in a test report is spelled out.

C14.3 COMPOSITE STEEL AND CONCRETE STRUCTURES

This section provides guidance on the design of composite and hybrid steel–concrete structures. Composite structures are defined as those incorporating structural elements made of steel and concrete portions connected integrally throughout the structural element by mechanical connectors, bonds, or both. Hybrid structures are defined as consisting of steel and concrete structural elements connected together at discrete points. Composite and hybrid structural systems mimic many of the existing steel (moment and braced frame) and reinforced concrete (moment frame and wall) configurations but are given their own design coefficients and factors in Table 12.2-1. Their design is based on ductility and energy dissipation concepts comparable to those used in conventional steel and reinforced concrete structures, but it requires special attention to the interaction of the two materials because it affects the stiffness, strength, and inelastic behavior of the members, connections, and systems.

C14.3.1 Reference Documents.

Seismic design for composite structures assigned to SDCs D, E, or F is governed primarily by AISC 341. Composite design provisions in ANSI/AISC 341 are less prescriptive than those for structural steel and provide flexibility for designers to use analytical tools and results of research in their practice. Composite structures assigned to SDC A, B, or C may be designed according to principles outlined in AISC 360 and ACI 318. ANSI/AISC 360 and ACI 318 provide little guidance on connection design; therefore, designers are encouraged to review ANSI/AISC 341 for guidance on the design of joint areas. Differences between older AISC and ACI provisions for cross-sectional strength for composite beam–columns have been minimized by changes in the latest AISC 360, and AISC 360 refers to ACI 318 for much of the design of reinforced concrete components of composite structures. However, there is not uniform agreement between the provisions in ACI 318 and AISC 360 regarding detailing, limits on material strengths, stability, and

strength for composite beam–columns. The composite design provisions in ANSI/AISC 360 are considered to be current.

C14.3.4 Metal-Cased Concrete Piles.

Design of metal-cased concrete piles, which are analogous to circular concrete filled tubes, is governed by Sections 14.2.3.1.3 and 14.2.3.2.4 of this standard. The intent of these provisions is to require metal-cased concrete piles to have confinement and protection against long-term deterioration comparable to that for uncased concrete piles.

C14.3.5 Seismic Requirements for Coupled Composite Plate Shear Walls --Concrete Filled (CC-PSW/CF).

C14.3.5.1 Scope.

A coupled composite plate shear walls - concrete-filled (CC-PSW/CF) is a coupled-wall system comprised of composite walls and composite coupling beams, for which both walls and beams consists of a concrete core sandwiched between two steel plates that serve as the primary reinforcement, replacing conventional rebars. These sandwich panels are depicted in Figure C14.3.5- 1. Tie bars connect the two steel plates together and provide stability during transportation and construction activities. After casting, the tie bars become embedded in the concrete infill and provide composite action between the steel and concrete. The coupling beams are built-up steel box sections with concrete infill. Similar to the wall panels, the built-up steel section provides primary reinforcement to the coupling beam. The empty steel modules, including both the walls and coupling beam components, are typically fabricated in the shop, transported to the site, erected, and filled with concrete. The composite walls can be planar, C-shaped, or I-shaped, following the typical geometric configurations of conventional concrete core walls.

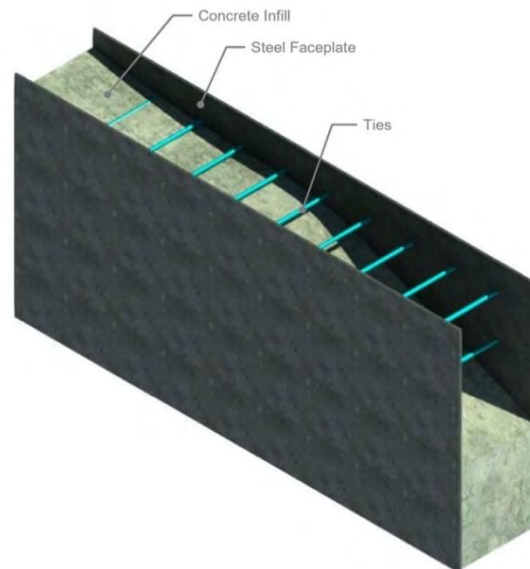

Figure C14.3.5- 1 Composite Plate Shear Wall Section – Concrete Filled

The requirement for composite walls to have height-to-length (h_w/L_w) ratio greater than or equal to 4.0 is specified to ensure that the walls are flexure critical, i.e., flexural yielding and failure governs behavior rather than shear failure. Calculations can also be performed to show that the wall is flexure-critical, i.e., plastic hinges (with flexural capacity equal to $1.2M_{p,exp}$) form at the base of the walls before

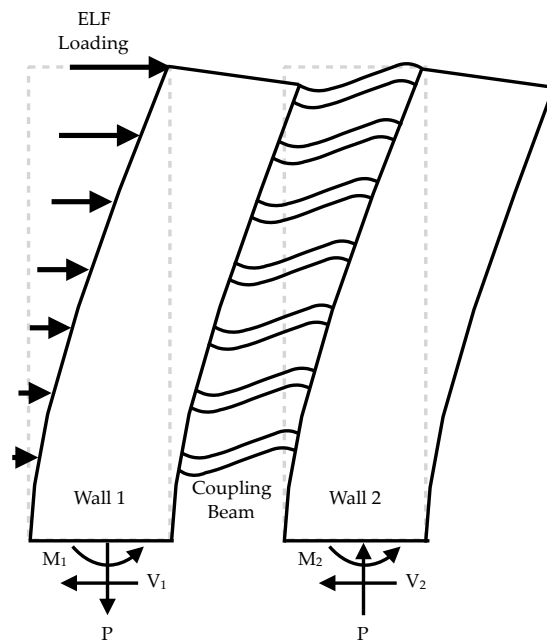

Figure C14.3.5- 2 Deformed shape of Coupled Composite Plate Shear Wall under Lateral Loads

shear failure occurs. The shortest archetype structure that was evaluated using the FEMA P695 approach for this system was three stories with two 45 feet tall composite walls of 10-foot length, corresponding to a height-to-length ratio equal to 4.5 for each wall that constituted the coupled wall.

The requirement for coupling beams to have length-to-depth ratios greater than or equal to 3 and less than or equal to 5 is based on: (i) the range of parameters included in the FEMA P695 studies conducted in order to establish the seismic factor (R) for the system, and (ii) the fact that coupling beams with length-to-depth ratios less than 3 tend to be shear critical, which is not recommended. Section 14.3.5.5.3 explicitly requires coupling beams to be flexure critical, i.e., flexural yielding and failure governs their behavior rather than shear failure.

C14.3.5.2 Basis of Design

The CC-PSW/CF system uses coupled walls to resist lateral loads as shown in Figure C14.3.5- 2. This system is expected to undergo significant inelastic deformation in large (design-basis and maximum considered) seismic events. The inelastic deformation has two sources: (1) flexural plastic hinges at the ends of coupling beams, and (2) flexural yielding at the base of walls. The preferred inelastic (failure) mechanism consists of forming flexural plastic hinges at both ends of the coupling beams and at the base of the composite walls. The design implements a strong wall-weak coupling beam approach that must be followed for appropriately sizing the composite members. This design approach helps achieve development of extensive plastic hinging in most of the coupling beams before significant yielding of the walls.

C14.3.5.3 Analysis

The design philosophy expressed in Section 14.3.5.3 leads to structures with the characteristic pushover behavior depicted in Figure C14.3.5- 3. The initial branch represents the elastic behavior of the structure, and the slope of this branch represents the effective structural stiffness which is approximated by elastic models such as those used with the Equivalent Lateral Force procedure (ELF) defined by ASCE 7. On the base shear-roof displacement curve, Point A represents the lateral load level corresponding to the ELF

distribution. The coupling beams are designed to reach their flexural capacity at this demand. As the lateral load (and base shear force) increases, the coupling beams along the height of the structure undergo flexural plastic hinging at both ends. The response reaches the next milestone, Point B, where all of the coupling beams have developed flexural hinges. The composite walls are designed to have a flexural capacity adequate to resist this demand level. The next milestone on the response, Point C, corresponds to the overall inelastic mechanism with flexural plastic hinging in all the coupling beams and the base of the composite walls. A final milestone, point D, represents fracture failure of the composite walls. The overstrength factor for this system, defined as the ratio of ultimate load capacity to capacity at ELF level loads, is approximately the ratio of base shear force at Point C to Point A.

The Seismic Response Modification Factor (R) is given in ASCE 7-16 for non-coupled composite plate shear walls to be equal to 6.5. A FEMA P695 (Quantification of Building Seismic Performance Factors) study was conducted to evaluate an appropriate R -Factor for CC-PSW/CF systems (Kizilarslan et al. 2018, 2019). This FEMA P695 study demonstrated that coupled composite plate shear walls considered here can be designed with a greater R -Factor of 8. This increase in the value of R for coupled walls is due to the spread of plastic hinging and inelastic deformations (energy dissipation) in the coupling beams along the height of the structure. This lateral load behavior is illustrated in Figure C14.3.5- 4 and Figure C14.3.5- 5 using finite element analysis for an 8-story archetype structure having coupling beams span-to-depth ratio of 5. The nonlinear static pushover behavior predicted by the finite element model (Figure C14.3.5- 4) follows the expected behavior presented in Figure C14.3.5- 3.

In the FEMA P695 study, archetype structures having 3, 8, 12, 18, and 22 stories and coupling beam span-to-depth ratios of 3, 4, and 5 were designed. The archetypes were designed using an R value of 8 and C_d value of 5.5. The 3, 8 and 12-story archetype structures used planar composite walls, while the 18 and 22 story archetype structures used C-shaped walls. These archetype structures were doubly symmetric in plan, and the wall thickness was uniform along the height of the structure. For the 18 and 22 story archetype structures, the thickness of the steel plates for the composite walls and the coupling beams was reduced in the top half of the structure. The 22 story archetype had an overall height of 311 ft. These structures were designed to meet the composite member and system requirements outlined in Section 14.3.5. The coupling ratio for the archetype structures was about 50 – 80%, where the taller buildings had higher coupling ratios. In this context, coupling ratio is defined at point B on the characteristic pushover curve as the proportion of the total overturning moment resisted by coupling action.

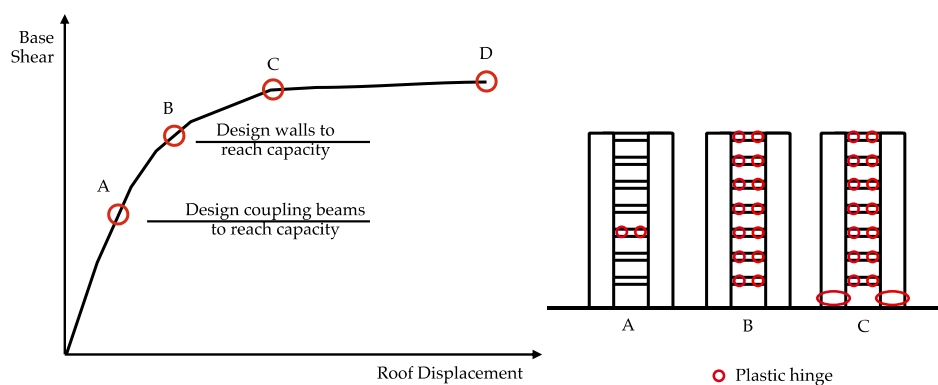

Figure C14.3.5- 3 Characteristic Pushover (Base Shear-Roof Displacement) Behavior (Broberg et al. 2019)

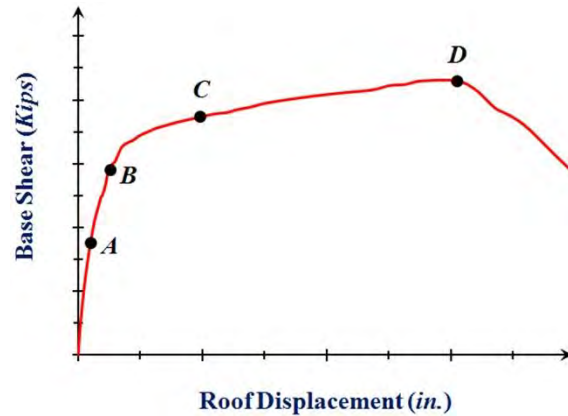

Figure C14.3.5- 4 Pushover Behavior from 3D FEM Analysis (Broberg et al. 2019)

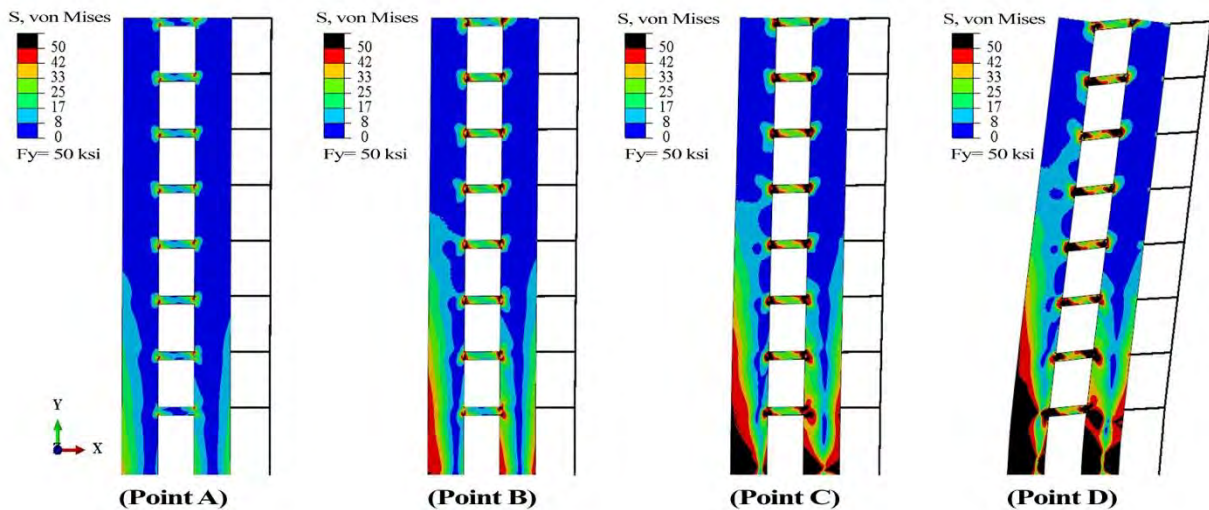

Figure C14.3.5- 5 Extent of Steel Yielding for Points on Pushover Curve (3D FEM from Broberg et al. 2019)

Seismic demands followed standards set in ASCE 7 and the FEMA P695 procedure. The numerical models for the structures accounted for the various complexities of flexural behavior of the coupling beams and composite walls including the effects of concrete cracking, steel yielding, local buckling, concrete crushing, and steel inelastic behavior up to fracture due to cumulative plastic strains and low cycle fatigue. The numerical models were benchmarked using experimental data available in the literature.

Results from the FEMA P695 analyses indicated that all archetypes reached collapse at drifts greater than 5%, but all collapse margin ratios established in this study were conservatively calculated based on results obtained at 5% drift (i.e., at less than actual collapse points). Consequently, collector beams must be designed to be able to accommodate up to 5% drift – note that in wall systems, at a given roof drift, the rotation in collector beams varies along the height of the walls. Results of the FEMA P695 studies indicated that collapse margin ratios increased for the taller buildings, which is consistent with the fact that code-specified drift limits governed the design of the 18 and 22 stories archetypes.

C14.3.5.3.1 Elastic Analysis.

An elastic model of the structure is used to conduct structural analysis for design by the Equivalent Lateral Force procedure (ELF) defined by ASCE 7. The results of this analysis are used to determine the design demands for the coupling beams and the maximum elastic story drift ratio, which is amplified by C_d to estimate the inelastic story drift ratio for design. This analysis can be performed in accordance AISC 360, Section 11.5, which is based on the direct analysis method, and includes recommendations for the flexural (EL_{eff}) and axial stiffness of filled composite members (i.e., composite coupling beams). The flexural (EL_{eff}) and axial stiffnesses (EA_{eff}) of composite walls can be calculated using cracked-transformed section properties corresponding to 60% of the calculated nominal flexural capacity of the wall (without accounting for axial force effects). It is important to use the reduced (cracked) axial stiffness of the walls as they have an influence on the structure lateral stiffness (and story drift) through the coupling frame action. The shear stiffness of the composite walls and coupling beams does not have a significant influence on the structure stiffness as flexure behavior dominates. As such, the uncracked composite shear stiffness can be used for both the coupling beams and composite walls.

C14.3.5.3.4. Capacity-Limited Analysis.

The design demands for the composite walls are estimated using a capacity-limited seismic load effect, E_{cl} , where all the coupling beams are assumed to develop plastic hinges at both ends with flexural capacity equal to $1.2M_{p,exp}$, i.e., at point B in Figure C14.3.5- 3. The total overturning moment at B can be estimated using the total overturning moment at point A in Figure C14.3.5- 3 amplified by the factor given below.

$$g_1 = \frac{\overset{\circ}{\Delta} 1.2M_{p,exp}^{cb}}{\overset{\circ}{\Delta} M_u^{cb}} \quad (C14.3.5-1)$$

where,

$\overset{\circ}{\Delta} 1.2M_{p,exp}^{cb}$ = sum of the expected flexural capacities of coupling beams along structure height

$\overset{\circ}{\Delta} M_u^{cb}$ = sum of the flexural design demands for the coupling beams along structure height

n = number of coupling beams along structure height

The capacity-limited shear force in the coupling beams can be summed over the height of the structure to estimate the axial forces acting in the walls as shown below.

$$P_w = \overset{\circ}{\Delta} \frac{2.4M_{p,exp}^{cb}}{L_{cb}} \quad (C14.3.5-2)$$

The portion of the total overturning moment resisted by coupling action can be estimated by the equal and opposite axial forces at the base of the walls (P_w) multiplied by the distance between them. The remaining portion of the total overturning moment can be distributed to the individual walls based on their effective flexural stiffness (while accounting for the effects of tensile or compressive axial force). The shear force in the walls obtained from this analysis is amplified by a factor of four to conservatively account for: (i) effects of higher modes, and (ii) the overstrength in the walls resulting from the difference between their expected flexural capacity (at point C in Figure C14.3.5- 3) and design demand (point B). For reinforced concrete walls, this amplification factor is about 2 – 3 (Wallace et al. 2019). A conservative value of 4 was used for

composite walls in the absence of better information, and in recognition of their inherent (significant) shear strength. The shear strength of these composite walls is very high due to the significant contribution of the steel plates and composite action.

C14.3.5.4 Composite Wall Requirements

C14.3.5.4.1 Minimum Area of Steel.

The minimum area of steel requirement is based on the AISC 360, Section I2 requirements for composite columns.

C14.3.5.4.2 Slenderness Requirement.

The steel plates of composite walls are required to be nonslender, i.e., yielding in compression must occur before local buckling. When subjected to compressive stresses, the plate undergoes local buckling between the steel ties or anchors as shown below. The horizontal lines joining the steel anchors (or ties) act as fold lines, and local buckling occurs between them. The buckling mode indicates fixed-ends along the vertical lines with steel anchors, and partially fixity along the vertical lines between steel anchors.

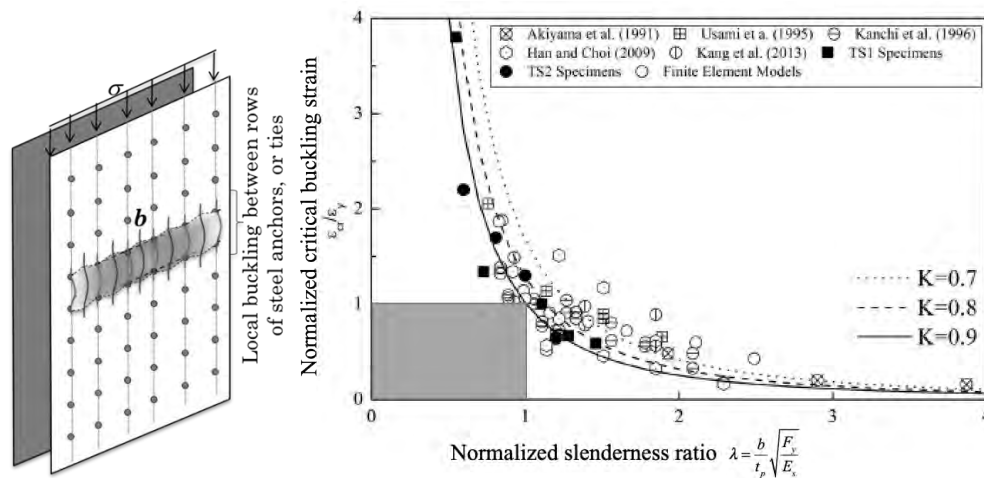

Figure C14.3.5- 6 Local buckling of steel plates, and plot of normalized critical buckling strain vs. slenderness ratio (Zhang et al. 2014, 2019)

Experimental studies have been conducted to evaluate the effects of plate slenderness ratio, s/t_p , defined as the steel anchor spacing, s , divided by the plate thickness, t_p , on local buckling of plates. Zhang et al. (2014, 2019) have summarized these experimental studies, and conducted additional numerical analyses to confirm and expand the experimental database. Figure C14.3.5- 6 from Zhang et al. (2014, 2019) shows the relationship between the normalized critical buckling strain (buckling strain/steel yield strain, ϵ_{cr}/ϵ_y) and the normalized plate slenderness ratio ($s/t_p \times F_y/E$). As shown, ϵ_{cr} is reasonably consistent with Euler's curve with a partially fixed ($K = 0.8$) end condition. Also, no data point falls in the shaded area, implying yielding occurs before local buckling for a normalized plate slenderness ratio less than 1.0. Since ties may also act as anchors, the equation considers the largest unsupported length between rows of steel anchors or ties, b .

C14.3.5.4.3 Tie Spacing Requirement for Composite Walls.

The tie spacing requirement is based on the flexibility and shear buckling of empty steel modules before concrete placement, discussed in detail in Shafaei et al. (2018). The flexibility of the empty modules for transportation, shipping and handling activities is dominated by their effective shear stiffness GA_{eff} , which can be estimated accurately using numerical models as shown in Shafaei et al. or calculated conservatively (for a unit cell of the module) using Eq. (C14.3.5-3). In this equation, I_p and I_t represent the moments of

inertia of the steel faceplates and tie bar. S and d_{tie} represent the tie spacing and bar diameter. Eq. (C14.3.5-4) defines a , which is the ratio of the flexural stiffness of the steel plate to the flexural stiffness of the tie bar, and simplifies to the form of Eq. (14.3.5-3).

$$GA_{eff} = 24 \left(\frac{EI_p}{S^2} \right) \frac{1}{(2a+1)} \quad (C14.3.5-3)$$

$$a = \frac{\left(\frac{E_s I_p}{S} \right)}{\left(\frac{E_s I_t}{t_{sc} - 2t_p} \right)} = \frac{\left(\frac{St_p^3}{12S} \right)}{\left(\frac{\rho d_{tie}^4}{64(t_{sc} - 2t_p)} \right)} = 1.7 \left[\frac{t_{sc}}{t_p} - 2 \right] \left[\frac{t_p}{d_{tie}} \right]^4 \quad (C14.3.5-4)$$

After assembly, and before concrete casting, the empty modules provide structural support for construction activities, loads, and the steel framework connected to it. The buckling of the empty module subjected to compression loading is also governed by its effective shear stiffness GA_{eff} , and can be estimated conservatively using Eq. (C14.3.5-5). The requirements of Eq. (14.3.5-2) and 3 will result in critical buckling stress greater than or equal to 1000 psi, which is equivalent to a distributed loading of 12,000 lbs per linear foot for walls with two 0.5 in. thick steel plates. The stresses and deflections induced by concrete casting hydrostatic pressure can also be estimated as shown in Shafaei et al. (2018). Research by Bhardwaj et al. (2018) indicates that modules that meet the plate slenderness requirement of Section 14.3.5.4.2 can be typically cast with concrete pour heights of up to 30 ft without significant influence of induced deflections and stresses on the compressive strength and buckling of the steel plates.

$$S_{cr} = \frac{E}{\left(\frac{S}{t_p} \right)^2} \frac{1}{(2a+1)} \quad (C14.3.5-5)$$

C14.3.5.4.4 Tie-to-Plate Connection.

This requirement develops the yield strength of the tie bars, and enables yielding before failure of the tie-to-plate connection. Samples of tie-to-plate connection details are shown below in Figure C14.3.5- 7 for round tie bars.

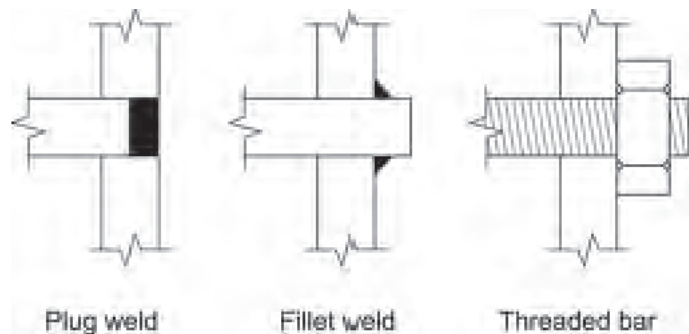

Figure C14.3.5- 7 Tie bar-to-plate connection detail samples

C14.3.5.5 Composite Coupling Beam Requirements

C14.3.5.5.1 Minimum Area of Steel.

The minimum area of steel requirement is based on the AISC 360, Section I2 requirements for composite columns.

C14.3.5.5.2 Slenderness Requirement for Coupling Beams.

The slenderness requirements are based on compact section requirements in the AISC 360, Section I1.4 for filled composite members. The web slenderness ratio requirement is based on developing the shear yield strength of the web plates before shear buckling as per AISC 360, Section G4. Figure C14.3.5- 8 shows a schematic of the coupling beam cross-section along with the clear widths of the flange and web plates.

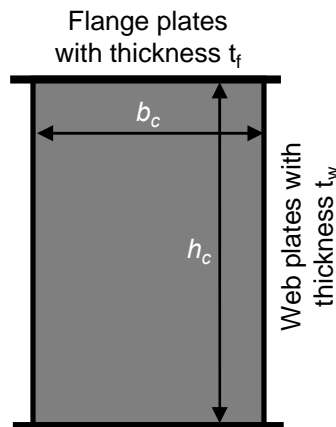

Figure C14.3.5- 8 Coupling beam cross-section

14.3.5.5.3 Flexure Critical Coupling Beams. This requirement is based on achieving flexure critical behavior in composite beams. The requirement increases the capacity-limited shear force capacity ($2M_{p,exp}/L_{cb}$) by a factor of 1.2 to account for the effects of steel inelastic hardening in tension, concrete confinement, the biaxial (tensile) stress effect in the steel tension flange.

C14.3.5.6 Composite Wall Strength

The requirements for axial tensile strength, compressive strength, flexural strength, and combined axial force and flexure are based on the recommendations for filled composite members in the AISC 360 Chapter I. The unsupported length for the flexural buckling of composite walls is typically equal to the story height. The requirements for flexural strength have been verified using experimental data by Kurt et al. (2016) and Alzeni and Bruneau (2017) and for combined axial force and flexure by Shafaei et al. (2019) and Bruneau et al. (2019) for C-shaped walls.

C14.3.5.5.4 In-Plane Shear Strength.

The in-plane shear behavior of composite walls is governed by the plane stress behavior of the plates and the orthotropic elastic behavior of concrete cracked in principal tension. Varma et al. (2014) and Seo et al. (2016) discuss the fundamental mechanics based model (MBM) for in-plane shear behavior of composite walls. The in-plane shear behavior can be estimated as the tri-linear shear force-strain curve shown in Figure C14.3.5- 9. The first part of the curve is before the concrete cracks. The second part is after the concrete cracking but before the plate yielding. The third part of the curve corresponds to the onset of plate Von Mises yielding. The shear force corresponding to this onset of von Mises yielding is given by Eq. (14.3.5-9). The corresponding principal compressive stress in the cracked (orthotropic) concrete is less than $0.7f'_c$

for typical composite walls with reinforcement ratios ($2t_p/t_{sc}$) less than or equal to 10%. For walls with very high reinforcement ratios (i.e., walls with very thick steel plates compared to overall thickness), the concrete principal compressive stress can be the limiting failure criterion (Seo et al. 2016, Varma et al. 2014)

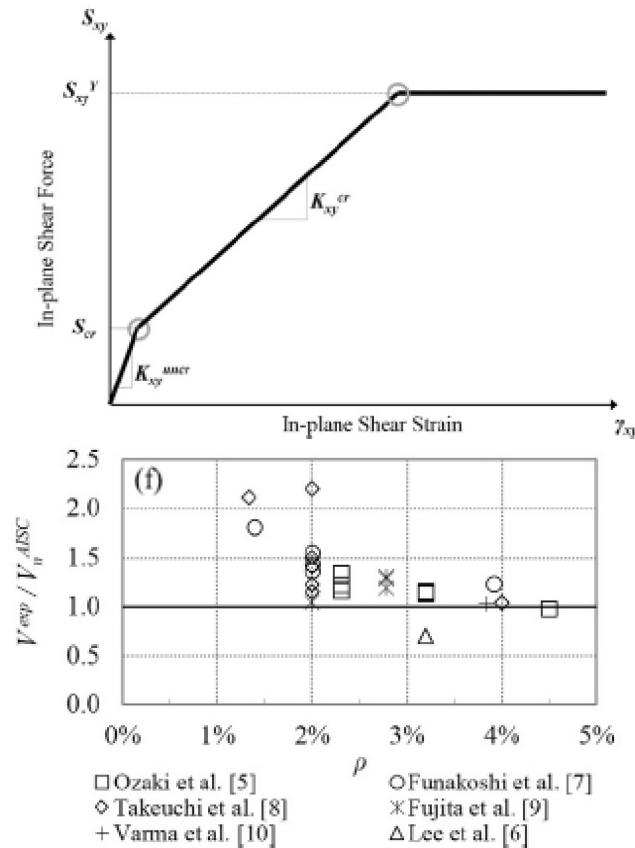

Figure C14.3.5- 9 In-plane shear force-strain response of composite walls, and comparison of experimental results with shear strength calculated using Eq. (14.3.5-9) (Seo et al. 2016)

C14.3.5.5 Nominal vs. Expected Flexural Capacity.

The flexural capacity of composite walls and coupling beams can be calculated using the plastic stress distribution method or the effective stress-strain method in AISC 360, Section I1.2. The nominal flexural capacity (with or without concurrent axial force) can be calculated using nominal steel (F_y) and concrete (f'_c) material strengths. The expected flexural capacity can be calculated using expected steel ($R_y F_y$) and concrete ($R_c f'_c$) material strengths. The expected flexural capacity is amplified by a factor of 1.2 to account for the effects of steel inelastic hardening in tension, concrete confinement, and the biaxial (tensile) stress effect in the steel tension flange.

C14.3.5.6 Composite Coupling Beam Strength

The requirements for flexural strength are based on the recommendations for filled composite members in the AISC 360 Chapter I. The requirements for shear strength are based on recommendations for filled composite members in AISC 360 Chapter I as modified to reflect the latest research (Lehman et al. 2018, Bruneau and Kenarangi 2018, Bruneau and Varma, 2019).

C14.3.5.8 Coupling Beam-to-Wall Connections

The coupling beam-to-wall connections are designed to develop and transfer the expected flexural capacity (and corresponding capacity-limited shear force) of the associated coupling beams. Figure C14.3.5- 10 shows the envelope of the inelastic moment-rotation response assumed in the FEMA P695 (analytical) studies for the flexural (plastic) hinges in the coupling beams. As shown, the plastic rotation before degradation of flexural capacity due to fracture failure was assumed to be equal to 0.025 rad.

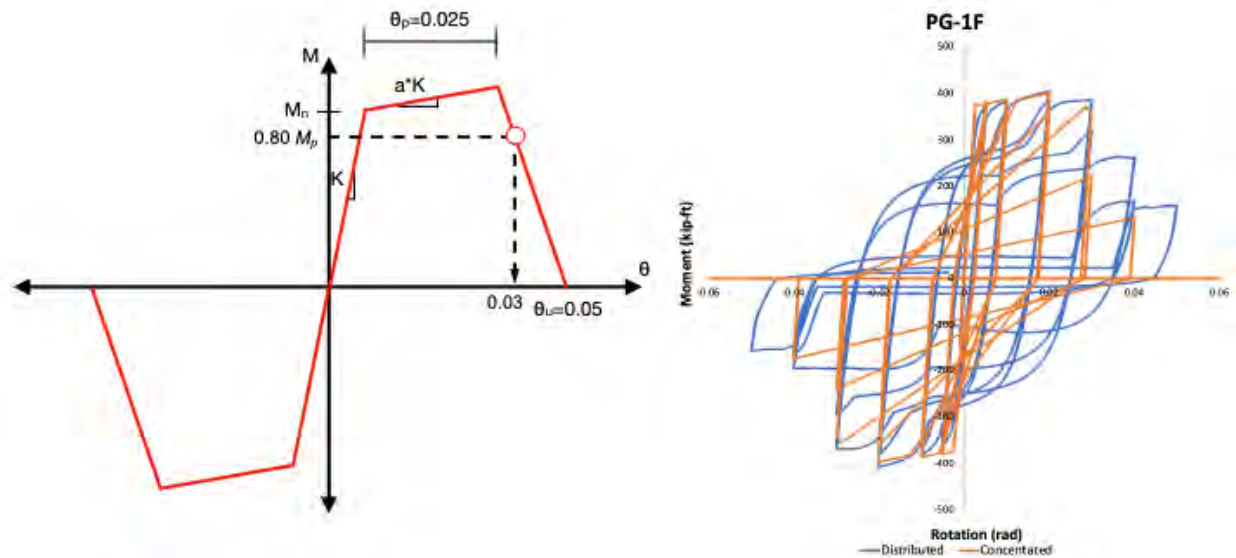

Figure C14.3.5- 10 Envelop of cyclic moment-rotation response and hysteretic behavior of plastic hinges in composite coupling beams (Broberg et al. 2019)

Coupling beam-to-wall connections have been tested in the past, for example, Nie et al. (2014), and additional testing of coupling beam-to-wall connections are currently ongoing. Some details that may be demonstrated to be acceptable by testing include those shown in Figure C14.3.5- 11 and Figure C14.3.5- 12. If the wall flange plate is interrupted, design must account for the local discontinuity in the contribution of the flange plate to wall flexural and axial strength.

Figure C14.3.5- 11 shows a connection where: (i) the web plates are continuous between the coupling beam and the composite walls, (ii) the coupling beam flange plates are continued into the wall, and welded to the wall web plates to develop their expected tensile strength, and (iii) the wall closure plate is interrupted at the coupling beam.

Figure C14.3.5- 12 shows a connection where: (i) coupling beam web plates are lapped and welded to the composite wall web plates, (ii) the coupling beam flange plates are continued into the wall, and welded to the wall web plates to develop their expected tensile strength, and (iii) the wall closure plate is not interrupted at the coupling beam.

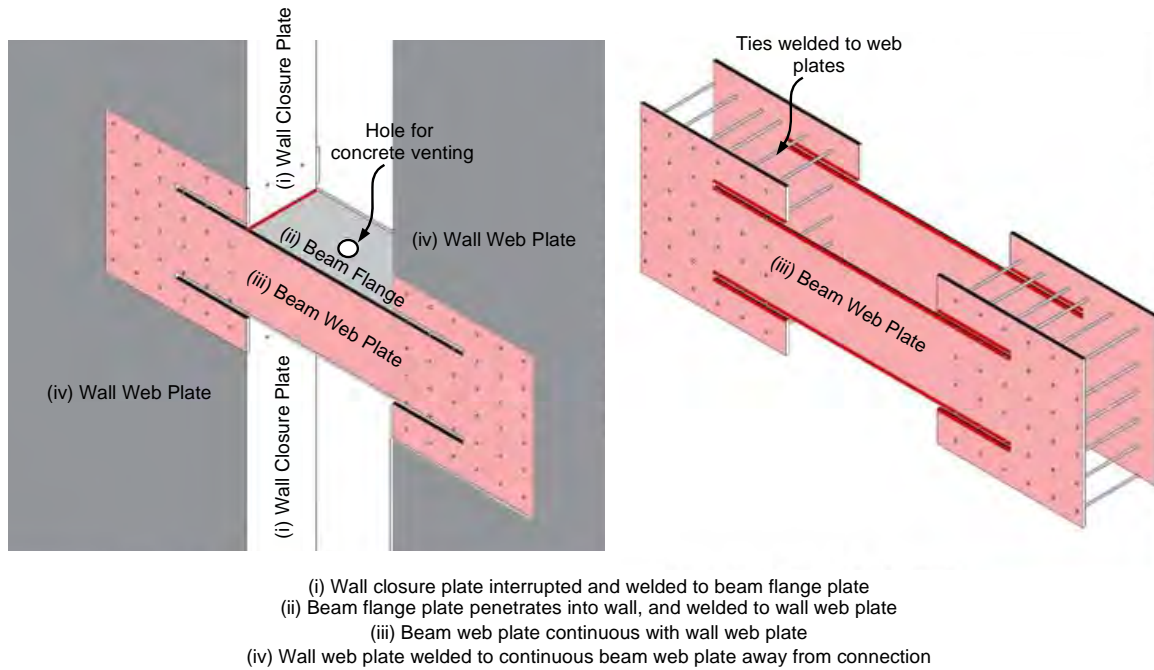

Figure C14.3.5- 11 Coupling beam connection with continuous web plate and interrupted wall closure plate

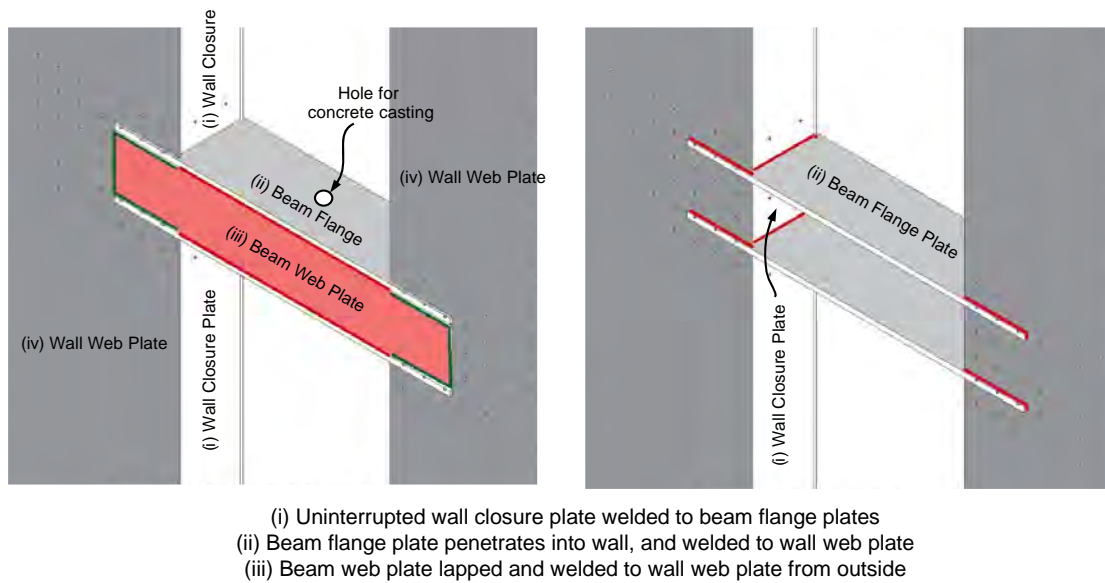

Figure C14.3.5- 12 Coupling beam connection with lapped web plate and continuous wall closure plate

C14.3.5.9 Composite Wall-to-Foundation Connections

For structures with sub-grade basement stories, the maximum shear force and overturning moment in the composite walls at the grade level can be transferred gradually through the basement stories. For structures that are connected to the concrete basemat / foundation at the location of maximum shear force and overturning moment, the wall-to-basemat connections have to be designed for: (i) the expected flexural capacity of the composite walls (accounting for effects of axial force), (ii) the expected axial forces associated with capacity-limited shear forces in the coupling beams, and (iii) and the amplified shear force demand (amplification factor of 4) used for the design of the composite walls. Some connection details that have been used in the past include details with welded base plates and rebar couplers as shown in Figure C14.3.5- 13. The base plate can be continuous or discontinuous across the wall thickness depending on the needs of the project and wall thickness. Another potential connection with the wall embedded in the concrete foundation is shown in Figure C14.3.5- 14.

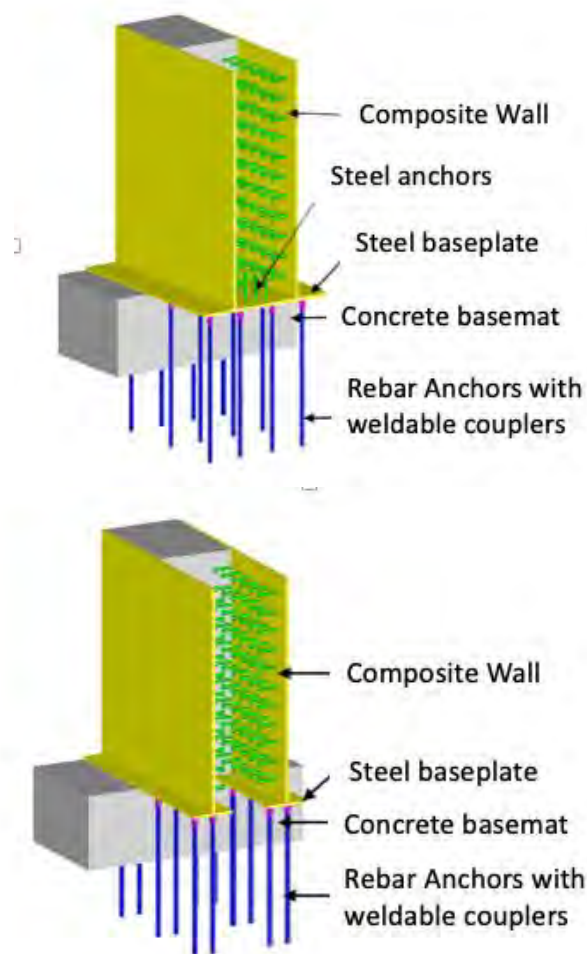

Figure C14.3.5- 13 Composite wall-to-basemat connections with welded base plate and rebar couplers (concrete only shown partially to highlight rebars and couplers) (Bhardwaj and Varma, 2016)

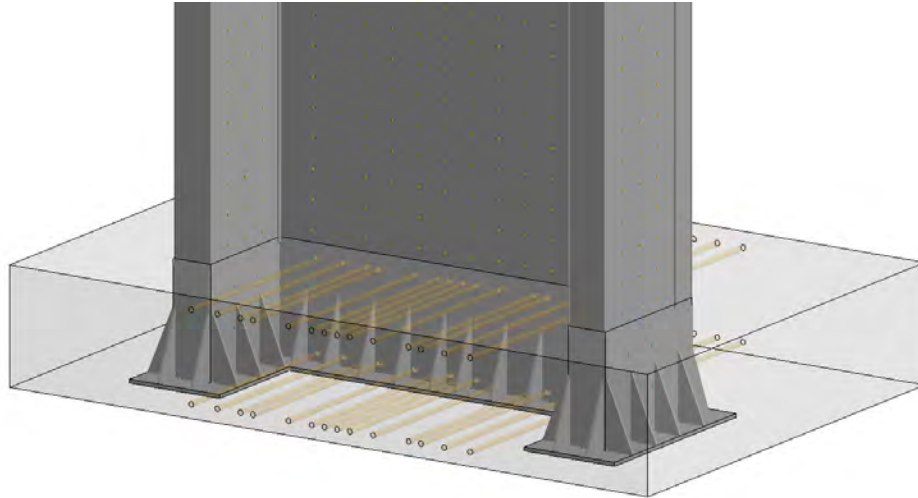

Figure C14.3.5- 14 Composite wall-to-basemat connections with wall embedded into concrete foundation (Bruneau et al., 2019)

C14.3.5.10 Protected Zones

Protected zones are defined in AISC 341 as regions of members or connections of members undergoing large inelastic strains or plastic hinging to provide significant inelastic deformation capacity and energy dissipation during design-basis or higher magnitude earthquakes. FEMA / SAC testing has demonstrated the sensitivity of these regions to discontinuities caused by fabrication or erection activities or from other attachments. For this reason, operations specified in AISC 341 Section I2.1 are prohibited in the protected zones.

For the CC-PSW/CF system, the protected zones are designated as the regions at the ends of coupling beams that will undergo significant inelastic straining and plastic hinging, and portions of the adjacent wall (if any) undergoing yielding at the connection. The typical length of the plastic hinge region will extend from the face of the composite wall to a distance equal to coupling beam depth. However, the extent of the plastic hinge (and the protected zone) can depend on the cross-section geometry, flange and web plate thicknesses, and the length-to-depth ratio of the coupling beam. The extent of the protected zone can be determined from analysis.

Additionally, the regions of the composite walls undergoing significant inelastic straining and plastic hinging are also designated as protected zone. The extent of the plastic hinge region undergoing significant inelastic strains (and the protected zone) can depend on wall cross-section geometry, web plate and flange (closure) plate thickness and lengths, and the height-to-length ratios of the walls. The extent of the protected zone can be determined from analysis.

C14.3.5.11 Demand Critical Welds

Demand critical welds are defined in AISC 341, and the requirements are specified in Section A3.4b and I2.3. These include requirements for the filler metals in terms of minimum levels of CVN toughness using two different test temperatures and specified test protocols, unless exempted from testing. Demand critical welds are generally complete-joint-penetration groove (CJP) welds because they are subjected to yield level or higher stress demand and located in joints where failure can result in significant degradation in strength or stiffness.

Welds used to connect the coupling beam flanges and web plates to the composite wall steel plates are designated as demand critical, and therefore required to meet the corresponding requirements.

Additionally, welds are used within the protected zones of coupling beams and composite walls are also designated as demand critical, and therefore required to meet the corresponding requirements. These include potential CJP welds connecting the composite wall flange (closure) plates to the web plates, potential CJP welds connecting the coupling beam web plates to flange plates in built-up box sections, potential CJP welds used in composite wall steel plate splices, and potential CJP welds used in composite wall steel plate-to-base plate connections.

C14.4 MASONRY

This section adopts by reference and then makes modifications to TMS 402 and TMS 602. In past editions of this standard, modifications to the TMS referenced standards were also made. During the development of the 2016 edition of TMS standards, each of these modifications was considered by the TMS 402/602 committee. Some were incorporated directly into the TMS standards. These modifications have accordingly been removed from the modifications in this standard. Work is ongoing to better coordinate the provisions of the two documents so that the provisions in Section 14.4 are significantly reduced or eliminated in future editions.

C14.5 WOOD

C14.5.1 Reference Documents.

Two national consensus standards are adopted for seismic design of engineered wood structures: the *National Design Specification* (AWC NDS-15), and the *Special Design Provisions for Wind and Seismic* (AWC SDPWS-15). Both of these standards are presented in dual allowable stress design (ASD) and load and resistance factor design (LRFD) formats. Both standards reference a number of secondary standards for related items such as wood materials and fasteners. AWC SDPWS addresses general principles and specific detailing requirements for shear wall and diaphragm design and provides tabulated nominal unit shear capacities for shear wall and diaphragm sheathing and fastening. The balance of member and connection design is to be in accordance with the AWC NDS.

C14.5.2 Seismic Requirements for Cross Laminated Timber Shear Walls

C14.5.2.1 Scope.

Requirements for CLT shear walls are based on research that demonstrates adequate adjusted collapse margin ratios using the FEMA P695 methodology (van de Lindt et al., 2019). CLT shear wall design requirements are intended to produce yielding of nails and metal connectors at CLT panel edges, and combined rocking and sliding behavior of individual wall panels prior to occurrence of the ultimate shear wall strength limit state associated with nailed connection failure. CLT shear walls can be in single panel or multi-panel configurations. Design unit shears are associated with uniform spacing of prescribed connectors at the bottom of the panel, top of the panel and at vertical edges of multi-panel shear walls. Typical single panel and multi-panel wall configurations are shown in Figure C14.5.2.1 and examples of typical connection details are depicted in Table C14.5.2.2. While angle connectors at top and bottom are shown on one face of the CLT wall panel only, it is permissible to place connectors on both faces and for the minimum requirement of two connectors per panel to be on opposite faces of the CLT wall panel. Multi-panel shear walls are formed by individual panels having the same aspect ratio to promote deformation compatibility within the shear wall. The design requirements produce yielding of the prescribed nailed connections and rocking behavior in the shear wall as depicted in Figure C14.5.2.2 when subjected to in-plane shear forces. Details of Table C14.5.2.2 do not incorporate concrete floor toppings for clarity of illustrating connector requirements for in-plane shear loading and added fastening for out-of-plane loads.

A clear space should be provided between such toppings and the vertical and horizontal legs of the connector to avoid inhibiting connector deformation (e.g. bending, tension and rotation) under in-plane shear loading of the shear wall.

C14.5.2.2 Application Requirements.

The CLT shear wall seismic force resisting system (SFRS) is intended for use in platform construction where all individual wall panels are single story clear height panels and the CLT floor panels are designed as the floor diaphragm. Elements of the gravity framing system can include but need not be limited to CLT walls, beams and columns, and light-frame walls. The required use of the CLT shear wall SFRS in platform construction precludes application for balloon frame construction associated with multi-story clear height wall panels. For gable end wall conditions, the requirement for wall panels of the same height necessitates a configuration of wall panels of the same height in the story below the gable end while the “triangular” gable end wall portion can be composed of CLT wall panels or other elements designed as the collector.

The design method requires similar seismic detailing (i.e. minimum panel aspect ratio and shear connections) for all CLT wall panels whether part of the designated seismic force-resisting system or not to promote deformation compatibility with the CLT shear wall system up to the point of failure. CLT wall panels that are not part of the designed seismic force-resisting system are expected to be present in addition to the CLT shear walls designed as the vertical elements of the seismic force-resisting system. In general, such added wall elements are considered to reduce in-plane shear demands on the seismic force-resisting system and improve the strength and stiffness of the building as a whole, much like the presence of sheathed walls in excess of the designed shear walls in a wood-frame shear wall structure. However, such added wall elements may produce adverse effects on the structural system response that must also be considered in seismic design of the structural system, including but not limited to the distribution of forces and load path to elements of the structural system which may require strengthening relative to a design ignoring the interaction with CLT wall panels that are not designed as shear walls. In addition, for seismic design, consideration must be given to the potential for CLT wall panels not designed as shear walls to create structural irregularities such as a weak story irregularity, torsional irregularity, in-plane discontinuity in vertical lateral force-resisting element irregularity, and out-of-plane offset irregularity.

A suggested method for evaluating the structure for the presence of 12.3.2 structural irregularities involves consideration of two separate cases representing bounding values of strength and stiffness contributed by the CLT panels that are not part of the designated SFRS: (1) considering elements that are part of the designated SFRS alone, and (2) considering elements that are not part of the designated SFRS in combination with the elements that are part of the designated SFRS. Per this method, the bounding values of strength for CLT panels that are classified as not part of the designated SFRS range from a minimum of zero in Case 1 to a maximum equal to shear wall strength associated with full overturning restraint in Case 2. For some structural irregularities, placement criteria rather than structural distribution of strength and stiffness can trigger an irregularity (e.g. out-of-plane offset, in-plane discontinuity and non-parallel system irregularity). Such irregularities can be triggered for CLT wall panels whether part of the designated SFRS or not part of the designated SFRS.

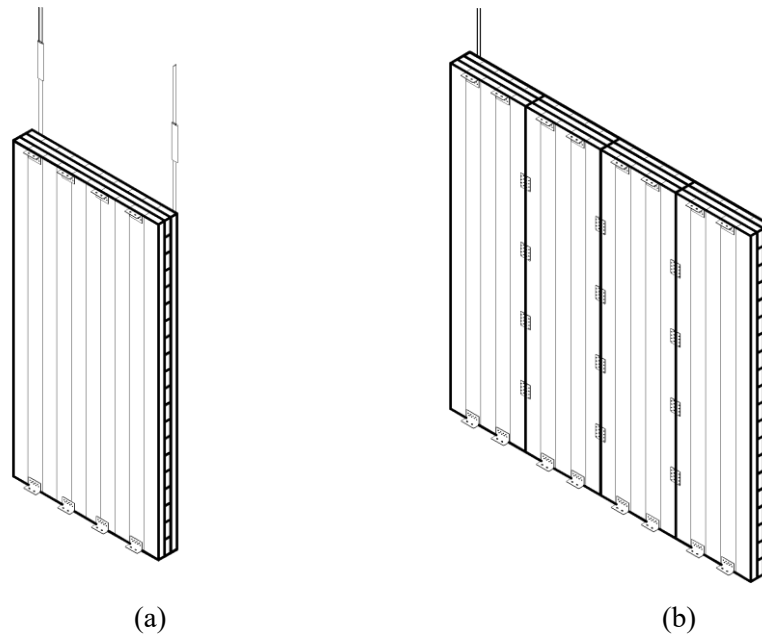

FIGURE C14.5.2.1. Typical Shear Wall for a) Single Panel Configuration, and b) Multi-panel Configuration

CLT wall panels with the prescribed nailed connectors are expected to contribute strength and stiffness over the full range of displacement expected of the CLT shear walls as seen in testing results of CLT shear walls with similar nailed connectors with and without hold-downs (FPInnovations, 2013). The extent to which CLT wall panels that are not part of the designated SFRS add strength and stiffness depends on the level of overturning restraint provided to the individual wall panels through dead load and overturning restraint by surrounding elements. The design requirements conservatively prescribe that the strength and stiffness contribution of such walls, for purposes of determining their adverse effect on the structural system, be taken as equal to a shear wall with full overturning restraint provided at wall ends. It is recognized that alternative design approaches may entail detailing of CLT wall panels to either isolate them from resisting in-plane shear forces or to minimize their resistance to in-plane shear forces (such as through use of slotted holes to promote sliding and/or rocking) while also providing equivalent deformation capacity to the prescribed in-plane shear connections. Where such alternative approaches are used, consideration of effects associated with the alternative design for CLT wall panels that are not part of the SFRS (including those associated with strength and stiffness of the alternative design elements) must be considered in the design of the structural system.

Loads are distributed to shear walls within the wall line based on the stiffness determined using Eq. (14.5.2-1) for each shear wall within the wall line. For distribution of shear to vertical elements of the SFRS, a diaphragm can be idealized as flexible, idealized as rigid, or modeled as semi-rigid in accordance with the requirements of the 12.3 and AWC SDPWS.

C14.5.2.3 CLT Shear Wall Requirements.

CLT shear wall requirements include use of CLT panels of prescribed aspect ratios; use of prescribed nailed connectors at bottoms of panels, tops of panels, and adjoining vertical edge(s) of multi-panel shear walls; a minimum required capacity for overturning tension devices; and compression zone length requirements. The prescribed angle connectors and connectors at the adjoining vertical edge of multi-panel shear walls have been evaluated under fully-reversed cyclic testing of shear walls and should not be modified or substituted without verification of equivalent shear wall performance by cyclic testing of shear walls that

evaluates simultaneous uplift and shear loading of the connectors. For the prescribed angle connector, observed failure from shear wall testing was due to combined nail bending, nail withdrawal from the wood, and limited occurrence of combined bending/tension failure of the nail, without metal connector failure. The prescribed connectors for the vertical edge provide equivalent shear capacity to that of the angle connectors at the top and bottom of the CLT shear wall. The prescribed connectors have been tested both as part of a shear wall and as individual components under uplift loading and shear loading. Testing employed bolts in the horizontal leg of the connectors. Lag screws are prescribed as an alternative with strength in shear and uplift capable of developing the tested strength of the nailed connector. Top- and bottom-of-wall angle connections are to be placed within 12 in. of each vertical edge of each panel of a single or multi-panel shear wall with 12 in. distance measured from the vertical edge of the CLT panel to the edge of the connector.

Design of CLT shear walls and associated load paths is in accordance with the basic load combinations of 2.3.6 or 2.4.5 (load combinations without overstrength) except where otherwise required by this standard. Hold-down requirements are intended for two common hold-down systems – continuous tie-rod systems and conventional hold-down device. For both, the required design for 2 times the forces associated with the design unit shear capacity of the CLT shear wall is intended to ensure shear strength in excess of the specified nominal strength of the shear connections and is consistent with level of overstrength in the hold-down system in CLT shear wall testing. A device elongation limit of 0.185 inches for strength design is required to be met at each level to avoid concentration of device elongation in one level and is based on ICC-ES evaluation criteria continuous tie-rod systems used with wood-frame shear walls and for conventional hold-downs devices attached to wood members.

Under in-plane unit shear loading, individual CLT panels within a CLT shear wall designed and detailed in accordance with 14.5.2 will rotate as shown in Figure C14.5.2.2. For purposes of determining tension force, T , and compression force, C , static equilibrium is based on consideration of the tension end panel and compression end panel depicted in Figure C14.5.2.3. Consistent with individual panel rotation behavior as opposed to overturning as a rigid body whole, the static analysis of individual panels is employed in determination of T and C forces. The contribution of dead load in the overturning design is specifically limited to only that dead load tributary to the individual panel and to elements aligned directly above the panel of interest per Figure C14.5.2.3. The dead load includes reactions from headers, beams, and similar elements when they are supported by the panel of interest. Vertical load reactions from floors above are to be applied to each panel of interest as C and T reactions for end panels and C reactions for interior panels, as applicable. As a result of this assumption of individual panel overturning, the overturning induced tension force is larger and overturning induced compression force is smaller than T and C forces associated with overturning the wall as a rigid monolith, primarily because the static analysis does not assume distributed gravity loading over the length of the wall can be mobilized via a whole-wall rigid body assumption to reduce the T force or increase the C force.

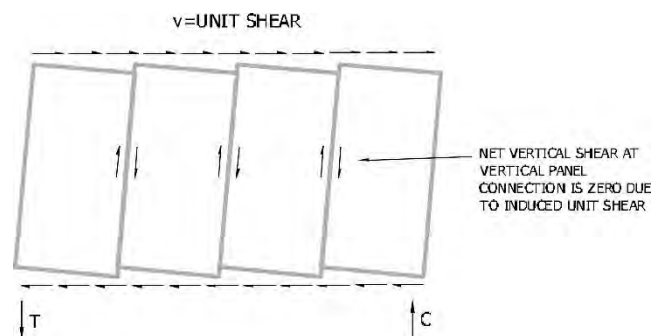

FIGURE C14.5.2.2. Rotation of Individual Panels in a CLT Shear Wall

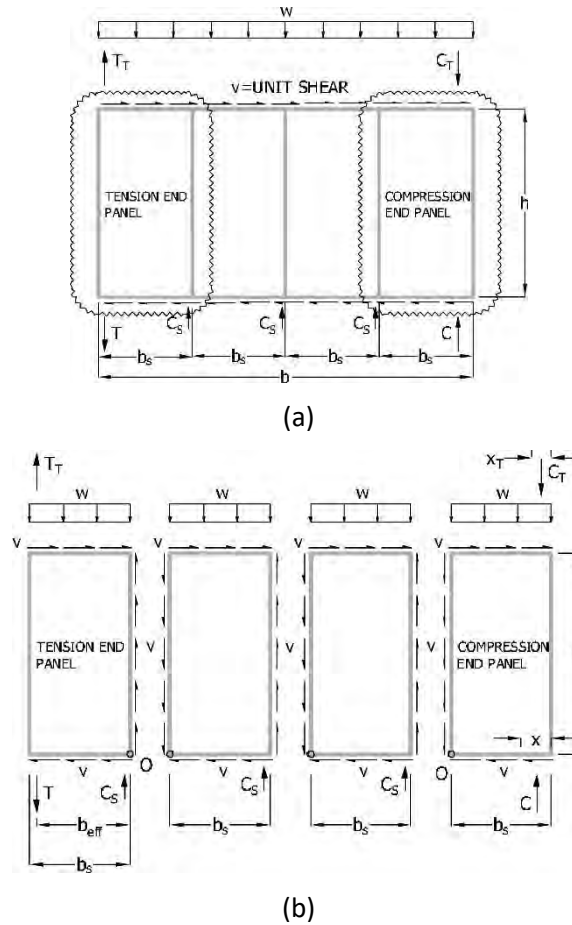

FIGURE C14.5.2.3. Combined Shear and Gravity Loading and Geometry for CLT Shear Wall Composed of Multiple CLT Panels (e.g. Multi-panel Shear Wall), a) Compression End and Tension End Panel Circled, and b) Illustration of Individual CLT Panel Overturning and Opposing Internal Shears at Adjacent Vertical Edges Due to In-plane Unit Shear Loading

For the tension end panel depicted in Figure C14.5.2.3, the tension force from summation of moment about point O is:

$$\sum M_o = 0$$

$$T * b_{eff} - (v * b_s * h) + w * b_s * \left(\frac{b_s}{2}\right) - T_T * b_{eff} = 0 \tag{C14.5.2-1}$$

$$T = [(v * b_s * h) - w * b_s * \left(\frac{b_s}{2}\right)] / b_{eff} + T_T \tag{C14.5.2-2}$$

where

v = unit shear, plf

w = dead load including wall panel self-weight, plf

b_s = CLT panel length, ft

b_{eff} = moment arm for calculation of T force, ft

h = CLT panel height, ft

T = tension force, lbf

T_T = tension force at top of tension end panel from story above, lbf

For the compression end panel depicted in Figure C14.5.2.3, the compression force from summation of moment about O is:

$$\sum M_o = 0$$

$$C * \left(b_s - \frac{x}{2}\right) - (v * b_s * h) - \left(w * b_s * \frac{b_s}{2}\right) - C_T \left(b_s - \frac{x_T}{2}\right) = 0 \quad (\text{C14.5.2-3})$$

where

v = unit shear, plf

w = dead load including wall panel self-weight, plf

b_s = CLT panel length, ft

h = CLT panel height, ft

C = compression force, lbf

b_s = CLT panel length, ft

x = length of compression zone, ft

C_T = compression force at top of compression end panel from story above, lbs

x_T = length of compression zone at top of compression end panel from story above, ft

The compression force associated with the length of the compression zone, assuming a uniform stress distribution (i.e. rectangular stress distribution) in the compression zone, is determined by the following equations:

$$C = F_{C\perp}'(t)(x)\left(\frac{12\text{in}}{\text{ft}}\right) \quad (\text{C14.5.2-4})$$

$$C = F_c'(t_{\text{parallel}})(x)\left(\frac{12\text{in}}{\text{ft}}\right) \quad (\text{C14.5.2-5})$$

where

x = length of compression zone, ft

C = compression force, lbs

F_{C⊥}' = bearing stress perpendicular to grain, psi

F_c' = design axial stress parallel to grain, psi

t = CLT wall panel thickness, in.

t_{parallel} = thickness of CLT wall panel layers oriented parallel to grain for determination of wall axial capacity, in.

12in./ft = conversion of compression zone length in feet to inches

The bearing resistance in Eq. (C14.5.2-4) is based on the compression perpendicular to grain stress associated with the CLT floor panel or wood bottom plate supporting the wall. The bearing resistance in Eq. (C14.5.2-5) is based on the design axial stress associated with the CLT wall panel parallel to grain layers and is applicable where designed compression zone elements are used to transfer such forces as

opposed to being limited by compression perpendicular to grain bearing stress in the floor panel. The designed compression zone force transfer detail through the floor panel is likely to be used in cases with a combination of high axial compression loads and high aspect ratio panels for the purpose of limiting wall thickness increases associated with meeting compression zone length requirements.

The length of the uniform stress compression zone, x , to satisfy static equilibrium is determined by substitution of Eq. (C14.5.2-4) or (C14.5.2-5) into Eq. (C14.5.2-3) and solving for x . The solution for x limited by bearing stress perpendicular to grain is provided in Eq. (C14.5.2-6).

$$x = \frac{6F'_{c\perp}tb_s - \sqrt{36F'^2_{c\perp}tb_s^2 - 6F'_{c\perp}t \left[vb_s h + \frac{wb_s^2}{2} + C_T \left(b_s - \frac{x_T}{2} \right) \right]}}{6F'_{c\perp}t} \quad (\text{C14.5.2-6})$$

Where the length of the compression zone, x , is smaller than the length of the compression end panel, b_s , a positive value under the root in Eq. (C14.5.2-6) is produced and the resulting value of x can be used to determine a precise value of compression force, C , in accordance with Eq. (C14.5.2-3). A negative value under the root of Eq. (C14.5.2-6) signifies the compression zone is not contained within the compression end panel. A preliminary check for whether adequate compression panel length is provided under unit shear loading alone (e.g. $w = C_T = 0$) can be obtained from Eq. (C14.5.2-7). When Eq. (C14.5.2-7) is not satisfied, a negative root will occur in Eq. C14.5.2-6 indicating inadequate compression panel length.

$$v \leq \frac{6F'_{c\perp}t}{h/b_s} \quad (\text{C14.5.2-7})$$

The loading and geometry depicted in Figure C14.5.2.3 for tension end and compression end panels are for purposes of illustrating a method to calculate an appropriate T and C force for the system. Testing shows rotation of the compression end panel is primarily about the outermost edge of the compression end panel – not about the centroid of the calculated compression zone. As such, using the loading and geometry depicted in Figure C14.5.2.3 for the compression end panel will underestimate the moment arm and overestimate vertical edge forces when summing forces vertically at that location. Results of such analysis should not be used to modify required vertical connector spacing in accordance with 14.5.2.3.3(3) which requires the same average vertical connector spacing with rounding as used for the top and bottom edges of the CLT shear wall. The required number of connections at vertical and horizontal edges (i.e. the same average spacing) provides balanced vertical and horizontal shear and enables the intended rotation behavior of individual panels of a multi-panel shear wall when subjected to in-plane unit shear loading.

C14.5.2.3.6 Other Load Path Connections to CLT Wall Panels.

Load path connections to CLT wall panels occur in addition to those of the designated seismic force-resisting system for in-plane shear resistance and include connections for out-of-plane forces for wind and seismic forces and general structural integrity. These additional load path connections include attachment of wall panels to elements above and below for out-of-plane forces, inter-connection of walls at intersections, and attachment of conventional hold-down devices at wall ends.

The combined requirement for fastener yielding per Mode III_s or IV and compliance with AWC NDS Appendix E ensures that added fastening provides a predictable yielding mechanism with levels of

overstrength similar to that provided by the prescribed connections for in-plane shear resistance. Top and bottom of wall connections for resistance to out-of-plane forces are in addition to prescribed angle connectors which do not have an established design value for loads perpendicular to the plane of the wall. Top and bottom of wall connections meeting requirements for yielding in Mode III_s or IV are considered beneficial to shear wall strength and stiffness, which is already governed by nail yielding, without degrading peak load and post-peak response of the prescribed shear wall connectors.

To address the potential for excessive screw (e.g. wood screw and lag screw) attachment to inhibit the rocking mechanism of the CLT panel due to high axial stiffness and strength of screws loaded in withdrawal, screw attachment of top and bottom of wall connections to supporting elements is not permitted. Screws used in these locations are considered an alternative to the prescribed smooth shank dowel fasteners (see Table 14.5.2.2 Typical connection details) at the top and bottom of wall locations and are subject to approval by the authority having jurisdiction. Typical fastening will employ smooth shank nails or pins to resist out-of-plane forces. Details for anchoring the top and bottom of walls for out-of-plane forces are not specifically prescribed to enable varying design options for meeting out-of-plane anchoring requirements.

C14.5.2.3.7 CLT Shear Walls with Shear Resistance Provided by High Aspect Ratio Panels Only.

CLT shear walls with shear resistance provided by high aspect ratio panels only is a specific configuration of the CLT shear wall system where high aspect ratio is defined as wall panel height to wall panel length ratio of 4. Minor variations in actual panel aspect ratio of +/- 2.5% are permissible such that actual panel aspect ratio range is 3.9 to 4.1. All requirements applicable for CLT shear walls are also applicable and additionally only CLT panels with aspect ratio of 4 are permissible as part of the designated shear wall system. CLT wall panels of equal or greater aspect ratio are permissible when not used as part of the designated shear wall system to promote deformation compatibility of CLT wall panels that are not designed as shear walls. Where CLT shear walls with shear resistance provided by high aspect ratio panels only is used, it is required that the aspect ratio requirement be met in all shear walls. While this limitation can be accommodated in single story and multi-story construction with equal story height it may not be practical to implement where story height varies of CLT shear walls with a permissible range in aspect ratio from 2 to 4 should be considered.

C14.5.2.4 Shear Wall Deflection.

The CLT shear wall deflection equation incorporates four primary components: individual wall panel bending, individual wall panel shear, sliding, and rigid body overturning. Individual panel rotation is included for multi-panel configurations. The deflection method accounts for the difference in observed stiffness of single and multi-panel CLT shear walls tested as well as influence of individual panel aspect ratio on shear wall deflection. Components of shear wall deflection are depicted in Figure C14.5.2.4.

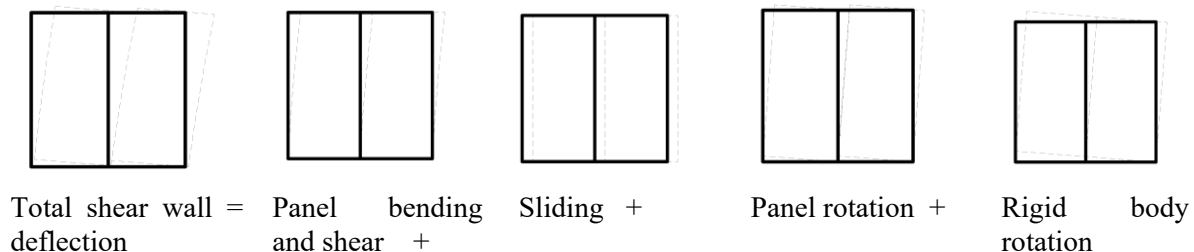

FIGURE C14.5.2.4. Shear Wall Deflection Components Due to Panel Bending and Shear, Sliding Due to Fastener Slip, Rotation due to Fastener Slip at Vertical Edge Connections, and Rigid Body Rotation

The bending term in the deflection equation is simplified from $\nu b_s h^3 / (3 * EI_{eff})$ for a cantilever with point load to $576 \nu b_s h^3 / (EI_{eff})$ to account for the unit conversion so that EI_{eff} can be in lb-in² and other units can be in feet. EI_{eff} is the effective in-plane panel stiffness for bending to account for composite behavior between adjacent parallel laminations where transverse E is approximated as longitudinal E/30. EI_{eff} can be calculated directly using transformed section properties or with the following equation presented in Blass and Fellmoser (2004):

$$(EI)_{eff} = \left[1 - \left(1 - \frac{E_{90,T}}{E_{0,L}} \right) \frac{a_{m-2} - a_{m-4} + \dots \pm a_1}{a_m} \right] E_{0,L} * \frac{b_s^3 * a_m}{12} \tag{C14.5.2-8}$$

where

$E_{0,L}$ = modulus of elasticity parallel to the grain for longitudinal layers (i.e. longitudinal E)

$E_{90,T}$ = modulus of elasticity perpendicular to the grain for transverse layers (i.e. transverse E taken as longitudinal E/30)

a_1, a_3, a_5 = longitudinal layers of CLT as shown in the Figure C14.5.2.5 for a 5-layer panel.

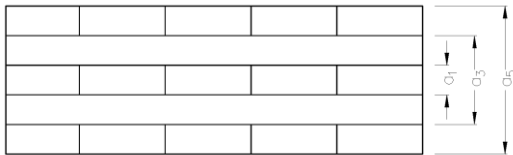

FIGURE C14.5.2.5. Illustration of a1, a3, and a5

The panel shear deformation term utilizes in plane shear stiffness, $GA_{eff (in-plane)}$, in units of pounds per inch (lb/in.). Example values of $GA_{eff (in-plane)}$ provided in Table C14.5.2.1 are calculated in accordance with Flaig M. and Blass H. (2013) per Eq. (C14.5.2-9) and Eq. (C14.5.2-10).

$$G_{eff,CA} = \frac{Kb^2}{5} \cdot \frac{n_{CA}}{t_{gross}} \cdot \frac{m^2}{(m^2+1)} \tag{C14.5.2-9}$$

$$G_{eff,CLT} = \left(\frac{1}{G_{lam}} + \frac{1}{G_{eff,CA}} \right)^{-1} \tag{C14.5.2-10}$$

where

K = slip modulus of crossing areas (Use $K = 4.0 \text{ N/mm}^3 = 14735 \text{ lb/in}^3$)

b = width of lamella

m = number of longitudinal lamellae

n_{CA} = number of glue lines within CLT cross section thickness

t_{gross} = CLT cross section thickness

G_{lam} = individual lamination shear modulus, psi (Use longitudinal E/16)

Table C14.5.2.1. Example $GA_{\text{eff (in-plane)}}$ for in-plane shear¹

	Number of Layers			
	3	5	7	9
G_{eff} , psi	28,700	32,300	33,700	34,500
$GA_{\text{eff (in-plane)}}$, lbs/in	118,300	222,000	324,500	426,600

1. Calculated values of G_{eff} and $GA_{\text{eff (in-plane)}}$ are based on use of Eq. (C14.5.2-9) and Eq. (C14.5.2-10) with the following inputs: $E=1,400,000$ psi, lamella width $b = 5.5$ in. (139.7 mm), number of longitudinal lamellae based on a 48 in. (1219.2 mm) panel width, slip modulus of crossing areas $K = 14,735$ lb/in³ (4.0 N/mm³) and lamella thickness = 1.375 in. (34.9 mm).

The sliding term, $V_{\text{nail load}}/(135,000 D^{1.5})$, addresses sources of deformation in the connector including nails and bolts. The slip constant takes into account loading perpendicular to the grain in the nailed connection. The single nail diameter of 0.135 in. (3.4 mm) used for all the connectors in this study, allows the use of a simplified nail slip term, $V_{\text{nail load}}/(6700)$. The deflection equation also explicitly breaks out sliding from multi-panel rotation due to vertical connection slip. If there is no vertical edge connection, then vertical connection slip equals 0 inches. The final term in the deflection equation represents rigid body rotation about the compression toe of the shear wall and is the same as used for sheathed wood-frame shear walls. Vertical deformation of the wall hold-down system, Δ_a , is based on the induced overturning forces and includes sources of deflection such as fastener slip, device elongation, rod elongation, uncompensated shrinkage, and vertical compression deformation.

C14.5.2.7 Diaphragm Requirements.

See SDPWS 4.1.5.1 and associated commentary for requirements applicable to wood members and systems resisting seismic forces contributed by masonry and concrete walls.

Table C14.5.2. Typical Connection Details

Wall panel to foundation connection

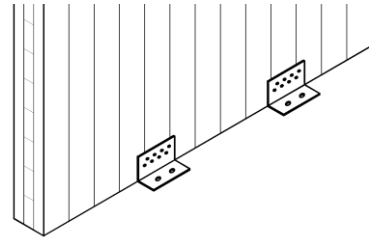
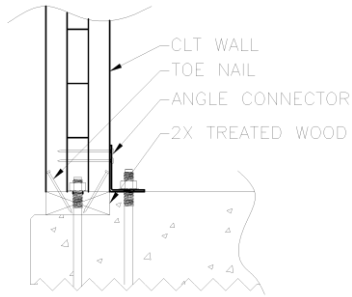
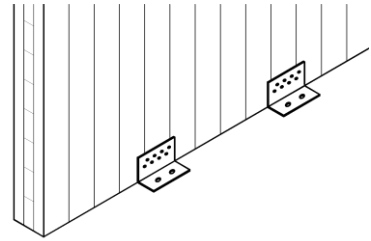
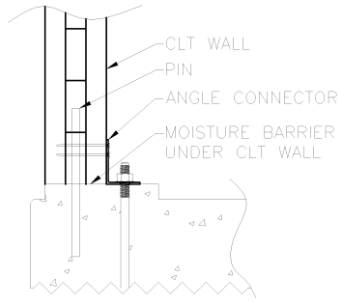

Exterior wall to floor connection

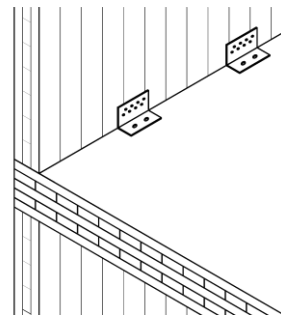
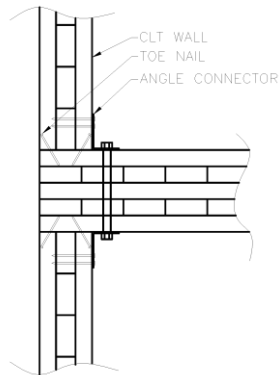
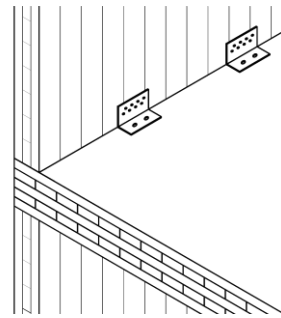
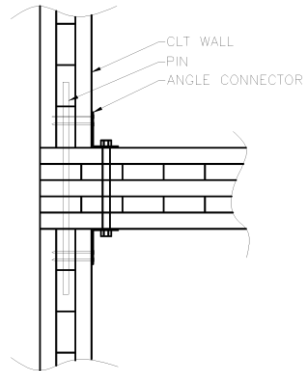

Exterior wall to floor connection (example with interior framed wall)

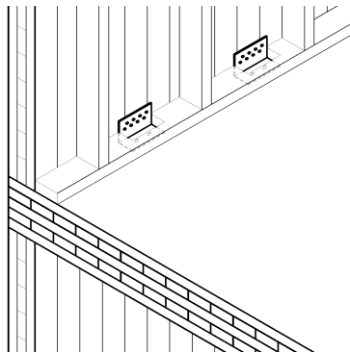
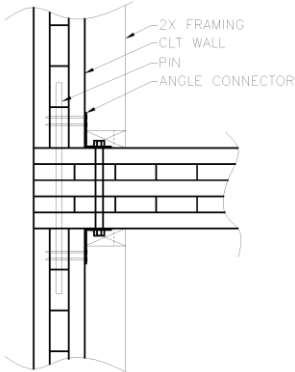

Interior wall to floor connection

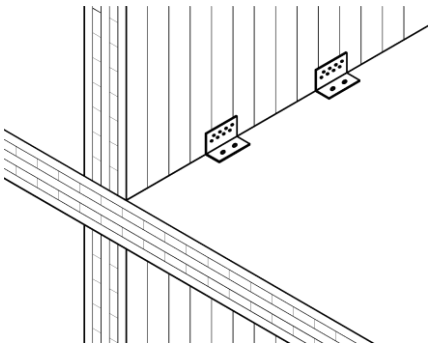
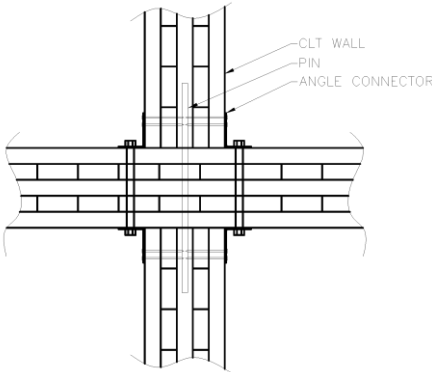

Exterior wall to roof

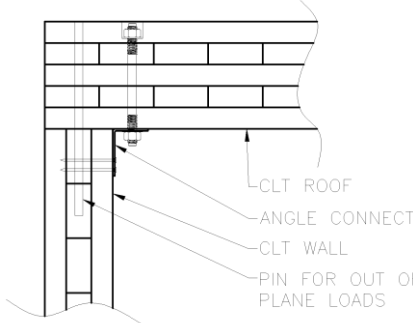

Exterior wall to roof

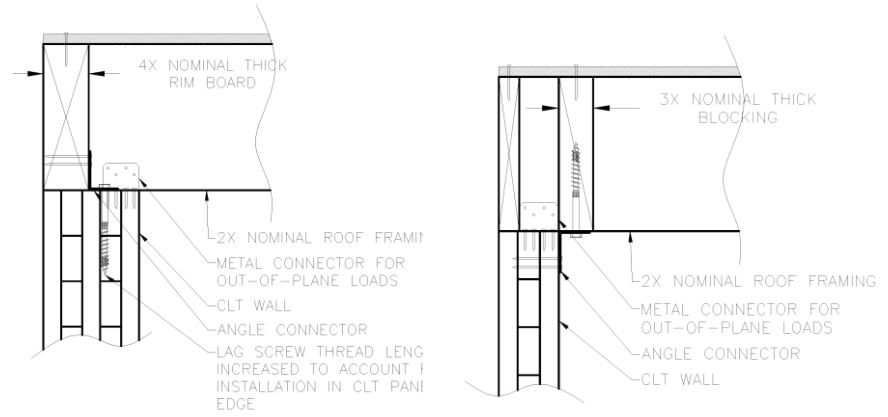

Interior wall to roof

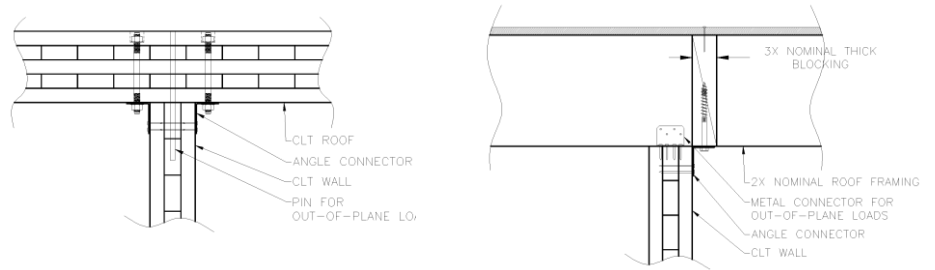

Wall panel to wall panel connection, square edge configuration (i.e. vertical edge connection)

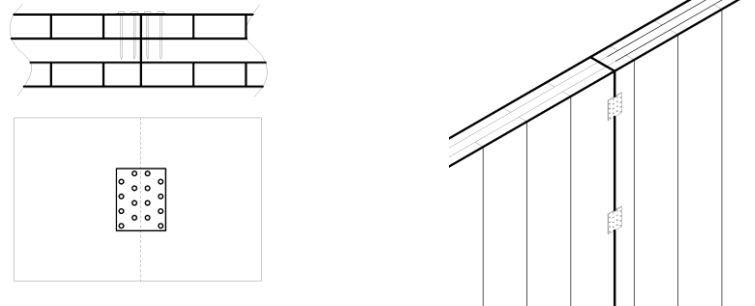

Wall panel to wall panel connection, lap configuration (i.e. vertical edge connection)

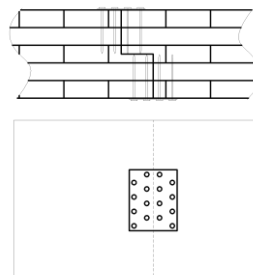

Multi-story overturning
restraint

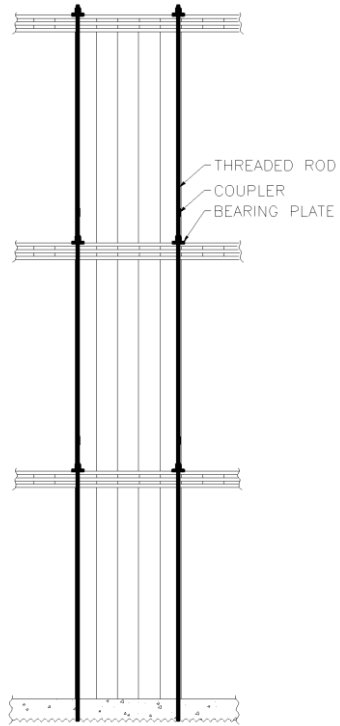

REFERENCES

- Alzeni, Y., Bruneau, M., (2017). “In-plane cyclic testing of concrete filled sandwich steel panel walls with and without boundary elements”, *ASCE Journal of Structural Engineering*, Vol.143, No.9, DOI: 10.1061/(ASCE)ST.1943-541X.0001791
- American Concrete Institute (ACI). (2014). “Building code requirements for structural concrete and commentary,” *ACI 318*, Farmington Hills, MI.
- American Institute of Steel Construction (AISC). (2016a). “Seismic provisions for structural steel buildings.” *ANSI/AISC 341*, Chicago.
- AISC. (2016b). “Specification for structural steel buildings.” *ANSI/AISC 360*, Chicago.
- American Iron and Steel Institute (AISI). (2015). “North American standard for cold-formed steel structural framing.” *ANSI/AISI S240*, Washington, DC.
- AISI. (2015). “Standard for cold-formed steel framing—Prescriptive method for one and two family dwellings.” *ANSI/AISI S230*, Washington, DC.
- AISI. (2015). “North American standard for seismic design of cold-formed steel structural systems” *ANSI/AISI S400*, Washington, DC.
- AISI. (2016). “North American specification for the design of cold-formed steel structural members.” *ANSI/AISI S100*, Washington, DC.
- AISI. (2016). “North American standard for the design of profiled steel diaphragm panels” *ANSI/AISI S310*, Washington, DC.
- ANSI/ASME Standard B18.2.1-2012, *Square, hex, heavy hex, and askew head bolts and hex, heavy hex, hex flange, lobed head, and lag screws (inch series)*, American Society of Mechanical Engineers, New York, NY, 2012.
- ANSI/AWC NDS-2018, *National design specification (nds) for wood construction*, American Wood Council, Leesburg, VA, 2018.
- ASCE. (2002). “Specification for the design of cold-formed stainless steel structural members.” *ASCE/SEI 8-02*. Reston, VA.
- ASCE. (2010). “Structural applications of steel cables for buildings.” *ASCE 19-10*, Reston, VA.
- ASCE/SEI Standard 7-16, *Minimum design loads and associated criteria for buildings and other structures*, American Society of Civil Engineers, Reston, VA, 2016.
- ASTM Standard A653-10, *Standard specification for steel sheet, zinc-coated (galvanized) or zinc-iron alloy-coated (galvannealed) by the hot-dip process*, ASTM, West Conshohocken, PA, 2010.
- ASTM Standard F 1667-15, *Standard specification for driven fasteners: nails, spikes, and staples*, ASTM, West Conshohocken, PA, 2015.
- American Wood Council (AWC). (2008). “Special design provisions for wind and seismic (wind and seismic).” *ANSI/AWC SDPWS-2012*, Leesburg, VA.
- AWC. (2012). “National design specification (NDS) for wood construction with commentary.” *ANSI/AWC NDS-2012*, Leesburg, VA.
- Banks, G., and Stanton, J. (2005). *Panel-to-panel connections for hollow-core shear walls subjected to seismic loading*. Proc., 2005 PCI Convention, Precast/Prestressed Concrete Institute, Chicago.
- Blass and Fellmoser (2004). *Design of solid wood panels with cross layers*. In *8th world conference on timber engineering* (Vol. 14, No. 17.6, p. 2004).

- Bhardwaj, S., and Varma, A.H. (2016). *AISC design guide 32: design of modular steel plate composite (sc) walls for safety related nuclear facilities*. AISC, Chicago, IL.
- Bhardwaj, S., Wang, A.Y., and Varma, A.H. (2018). "Slenderness requirements for cf-cpsw: the effects of concrete casting." Proceedings of the Eighth International Conference on Thin-Walled Structures, *ICTWS 2018*, Lisbon, Portugal, July 24-27. ISBN: 978-989-20-8665-1
- Broberg, M., Shafaei, S., Seo, J. Varma, A.H. (2019). *Introduction to the seismic behavior of coupled composite plate shear wall – concrete filled*. Engineering Journal, AISC, In Preparation
- Bruneau, M., and Kenarangi, H. (2018). *Investigation of cyclic shear behavior of circular reinforced concrete filled steel tubes*. Journal of Structural Engineering, Under Review.
- Bruneau, M., and Varma, A.H. (2019). *Shear strength of filled composite members*. Engineering Journal, AISC, In Preparation.
- Bruneau, M., Kizilarlan, E., Kenarangi, H. (2019) *Cyclic behavior of c-shaped composite plate shear walls – concrete filled*. Journal of Structural Engineering, ASCE, In Preparation
- Booth, P., Varma, A.H., and Seo, J. (2015). *Lateral load capacity of steel plate composite wall structures*. Transactions of SMiRT 23 in Manchester, UK, Paper ID 791, IASMiRT, North Carolina State University, Raleigh, NC, pp. 1-10, http://smirt23.uk/attachments/SMiRT-23_Paper_791.pdf
- Essa, H. S., Tremblay, R., & Rogers, C. A. (2003). "Behavior of roof deck diaphragms under quasistatic cyclic loading." Journal of Structural Engineering, 129(12), 1658-1666. 10.1061/(ASCE)0733-9445(2003)129:12(1658)
- Fanous, A. , Sritharan, S. , Suleiman, M. , and Arulmoli, A. (2007). *Minimum spiral reinforcement requirements and lateral displacement limits for prestressed concrete piles in high seismic regions* . Department of Civil, Construction and Environmental Engineering, Iowa State University, ISU-ERI Ames Report, Ames, IA.
- FEMA P-1026 (2015). *Seismic design of rigid wall-flexible diaphragm buildings: an alternate procedure (FEMA P-1026)*. Federal Emergency Management Agency.
- Flaig M. and Blass H (2013). "Shear strength and shear stiffness of CLT-beams loaded in plane." *CIB-W18 Meeting 46*, Vancouver, Canada, 2013, Paper 46-12-3.
- FPInnovations (2013). *US clt handbook, special publication sp-529e*. Pointe-Claire, QC, Canada.
- van de Lindt, J., Rammer, D., Line, P., Amini, M., Pei, S., and Popovski, M. *Determination of seismic performance factors for cross-laminated timber shear walls based on the fema p695 methodology*. USDA FPL & CSU, June 12, 2019.
- International Code Council (ICC). (2012). *International building code*. Country Club Hills, IL.
- Kizilarlan, E., Seo, J., Broberg, M., Shafaei, S., Varma, A.H., Bruneau., M., (2018). *R-factors for coupled composite plate shear walls—concrete filled (Coupled-C-PSW/CF)*, Interim Project Report #2, Submitted to the Charles Pankow Foundation for CPF research grant #06-16.
- Kizilarlan, E., Seo, J., Broberg, M., Shafaei, S., Varma, A.H., Bruneau., M., (2019). *Seismic design coefficients and factors for coupled composite plate shear walls—concrete filled (Coupled-C-PSW/CF)*, to be published.
- Koliou, M., Filiatrault, A., Kelly, D. J., & Lawson, J. (2016). "Buildings with rigid walls and flexible roof diaphragms. I: Evaluation of current U.S. seismic provisions." *Journal of Structural Engineering*, 142(3)10.1061/(ASCE)ST.1943-541X.0001438

- Koliou, M., Filiatrault, A., Kelly, D. J., & Lawson, J. (2016b). "Buildings with rigid walls and flexible roof diaphragms. II: Evaluation of a new seismic design approach based on distributed diaphragm yielding." *Journal of Structural Engineering*, 142(3)10.1061/(ASCE)ST.1943-541X.0001439
- Kurt, E.G., Varma, A.H., Booth, P.N., and Whittaker, A., (2016). *In-plane Behavior and Design of Rectangular SC Wall Piers Without Boundary Elements*. ASCE Journal of Structural Engineering, Vol. 142, No. 6, [http://dx.doi.org/10.1061/\(ASCE\)ST.1943-541X.0001481](http://dx.doi.org/10.1061/(ASCE)ST.1943-541X.0001481)
- Lehman, D., Roeder, C., Heid, A., Maki, T., and Khalegi, B., (2018). *Shear Response of Concrete Filled Tubes. Part 1: Experiments*. Journal of Constructional Steel Research, Volume 150, November 2018, Pages 528-540, <https://doi.org/10.1016/j.jcsr.2018.08.027>
- Masonry Standards Joint Committee (MSJC). (2005a). "Building code requirements for masonry structures." *ACI 530-05/ASCE/SEI 5-05/TMS 402-5*, Farmington Hills, MI.
- MSJC. (2005b). "Specification for masonry structures." *ACI 530.1-05/ASCE/SEI 6-05/TMS 602-05*, Farmington Hills, MI.
- Naito, C., Peter, W., Cao, L. (2006). "Development of a seismic design methodology for precast diaphragms—Phase 1 Summary Report," *ATLSS Report No. 06-03*, January, ATLSS Center, Lehigh University, Bethlehem, PA.
- Naito, C., Ren, R., Jones, C., Cullent, T. (2007). "Development of a seismic design methodology for precast diaphragms—Connector performance, Phase 1B," *ATLSS Report No. 07-04*, June, ATLSS Center, Lehigh University, Bethlehem, PA.
- Nakaki, S., Stanton, J. F., and Sritharan, S. (2001). "The PRESSS Five-Story Precast Concrete Test Building, University of California, San Diego, La Jolla, California," *PCI J.*, 46(5), 20–26.
- Nakaki, S., Becker, R., Oliva, M. G., and Paxson, D. (2005). *New connections for precast wall systems in high seismic regions*. Proc., 2005 PCI Convention, Precast/Prestressed Concrete Institute, Chicago.
- NBM (2017) *Cyclic performance and characterization of steel deck connections*. NBM Technologies report to AISI/SDI/SJI, 14 December 2017
- NBM (2018) "Button punch sidelaps (cyclic testing program)" NUCOR-Verco/Vulcraft Group, *Project number 103-042-18*, 11 July 2018 (released by Verco for public use)
- Nie, J.-G., Hu, H.-S., and Eatherton, M. R. (2014). "Concrete filled steel plate composite coupling beams: Experimental study." *Journal of Constructional Steel Research*, Elsevier, 94 49-63.
- O'Brien, P., Eatherton, M.R., Easterling, W.S. (2017). "Characterizing the load-deformation behavior of steel deck diaphragms using past test data." *CFSRC Report 2017-02*. access at <http://jhir.library.jhu.edu/handle/1774.2/40633>
- PCI Committee on Prestressed Concrete Piling. (1993). "Recommended practice for design, manufacture and installation of prestressed concrete piling." *PCI J.*, 38(2), 14–41.
- Precast/Prestressed Concrete Institute (PCI). (2004). "Precast/prestressed concrete piles." Bridge design manual, *BM-20-04*. PCI, Chicago.
- Ren, R., and Naito, C. J. (2013). "Precast concrete diaphragm connector performance database." *J. Struct. Eng.*, 139(1), 15–27.
- Sato, A., and Uang, C.-M. (2007). "Development of a seismic design procedure for cold-formed steel bolted frames," *Report No. SSRP-07/16*, University of California, San Diego.
- Schafer, B.W. (2019). "Research on the seismic performance of rigid wall flexible diaphragm buildings with bare steel deck diaphragms." *CFSRC Report R-2019-02*.

- Schultz, A. E. , and Magana, R. A. (1996). “Seismic behavior of connections in precast concrete walls.” Proc., Mete A. Sozen Symposium, *SP-162* , American Concrete Institute, Farmington Hills, MI, 273–311.
- SDI (2015) *Diaphragm design manual, 4th Ed.*, Steel Deck Institute (also known as DDM04).
- SDI (2016) *Manual of construction with steel deck, 3rd Ed.*, Steel Deck Institute.
- SDI (2017) *Quality control and quality assurance for installation of steel deck.* ansi/SDI QA/QC-2017 Standard. Steel Deck Institute.
- Seo, J., Varma, A.H., Sener, K., and Ayhan, D. (2016). *Steel-plate composite (sc) walls: in-plane shear behavior, database, and design.* Journal of Constructional Steel Research, Elsevier Science, Volume 119, Pages 202-215, <http://dx.doi.org/10.1016/j.jcsr.2015.12.013>
- Shafaei, S., Seo, J., and Varma, A.H. (2019). *Cyclic behavior of planar composite plate shear walls – concrete filled.* Journal of Structural Engineering, ASCE, In Preparation.
- Shafaei, S., Wang, A., Varma, A.H., and Morgen, B. (2018). *Stability of steel modules during construction.* Proceedings of the Annual Stability Conference, Baltimore, MD, April 10-13, 2018.
- Steel Deck Institute (SDI). (2015). *Diaphragm design manual, 4th Ed.*, DDM04, Glenshaw, PA.
- The Masonry Society (TMS). (2016). “Building code requirements and specification for masonry structures.” *TMS 402-16* , Longmont, CO.
- The Masonry Society (TMS). (2016). “Specification for masonry structures.” *TMS 602-16* , Longmont, CO.
- Varma, A.H., Malushte, S., Sener, K., and Lai, Z., (2014). *Steel-plate composite (SC) walls for safety related nuclear facilities: design for in-plane force and out-of-plane moments.* Nuclear Engineering and Design, Special Issue on SMiRT-21 Conference, Vol. 269, pp. 240-249, Elsevier Science, <http://dx.doi.org/10.1016/j.nucengdes.2013.09.019>
- Wallace, J. et al. (2019). *R-factor for coupled concrete core wall system.* Report to the Charles Pankow Foundation.
- Wei, G., Eatherton, M.R., Schafer, B.W. (2019). “Development of steel deck diaphragm seismic design provisions for asce 41/aisc 342.” *CFSRC Report R-2019-01.* <http://jhir.library.jhu.edu/handle/1774.2/59927>
- Zhang, K., Varma, A.H., Malushte, S., and Gallocher, S. (2014). *Effects of shear connectors on the local buckling and composite action in steel concrete composite walls.* Nuclear Engineering and Design, Special Issue on SMiRT-21 Conference, Vol. 269, pp. 231-239, Elsevier Science, <http://dx.doi.org/10.1016/j.nucengdes.2013.08.035>
- Zhang, K., Varma, A.H. and Seo, J. (2019). *Steel-plate composite (SC) walls: behavior and design and behavior for axial compressive loading.* Journal of Structural Engineering, ASCE, submitted for review.

OTHER REFERENCES (NOT CITED)

- American Institute of Timber Construction. (2005). *Timber construction manual, 5th Ed.* Wiley & Sons, New York.
- APA–The Engineered Wood Association. (1994). “Northridge California earthquake.” *T94-5* , Tacoma, WA.
- APA–The Engineered Wood Association. (2004). “Diaphragms and shear walls design/construction guide.” *L350* , Tacoma, WA.
- Applied Technology Council. (1981). “Guidelines for the design of horizontal wood diaphragms.” *ATC-7*, Redwood City, CA.

- Bora, C. , Oliva, M. G. , Nakaki, S. D. , and Becker, R. (2007). “Development of a precast concrete shear-wall system requiring special code acceptance.” *PCI J.* , 52(1), 122–135.
- Breyer, D. , Fridley, K., Jr. , Pollack, D. , and Cobeen, K. (2006). *Design of wood structures ASD/LRFD*, 6th Ed., McGraw-Hill, New York.
- Canadian Wood Council. (1995). *Wood reference handbook*. Canadian Wood Council, Ottawa.
- CWC. (2005). *Wood design manual*. Canadian Wood Council, Ottawa.
- Charles Pankow Foundation. (2014). *Seismic design methodology document for precast concrete diaphragms*. CPF, Vancouver, WA, January 23.
- Cobeen, K. (2004). *Recent developments in the seismic design and construction of woodframe buildings*. Earthquake engineering from engineering seismology to performance-based engineering , Y. Bozorgia , and V. Bertero , eds., CRC Press, Boca Raton, FL.
- Consortium of Universities for Research in Earthquake Engineering (CUREE). (2004). “Recommendations for earthquake resistance in the design and construction of woodframe buildings,” *CUREE W-30* . CUREE, Richmond, CA.
- Dolan, J. D. (2003). *Wood structures. Earthquake engineering handbook* , W-F. Chen , and C. Scawthorn , eds., CRC Press, Boca Raton, FL.
- Earthquake Engineering Research Institute (EERI). (1996). *Northridge earthquake reconnaissance report. Earthq. Spectra* , Chapter 6, Suppl. C to Vol. 11, EERI, Oakland, CA.
- Essa, H. S., Tremblay, R., & Rogers, C. A. (2003). “Behavior of roof deck diaphragms under quasistatic cyclic loading.” *Journal of Structural Engineering*, 129(12), 1658-1666. 10.1061/(ASCE)0733-9445(2003)129:12(1658)
- Faherty, K. F. , and Williamson, T. G. (1989). *Wood engineering and construction handbook* . McGraw-Hill, New York.
- Federal Emergency Management Agency (FEMA). (2003). “NEHRP recommended provisions for seismic regulations for new buildings and other structures.” *FEMA 450* , FEMA, Building Seismic Safety Council, Washington, DC.
- FEMA P-1026 (2015). *Seismic design of rigid wall-flexible diaphragm buildings: an alternate procedure (FEMA P-1026)*, Federal Emergency Management Agency.
- FEMA. (2005). “Coastal construction manual,” 3rd Ed., *FEMA 55*. FEMA, Washington, D.C.
- Forest Products Laboratory. (1986). *Wood: Engineering design concepts* . Materials Education Council, Pennsylvania State University, University Park, PA.
- Goetz, K. H. , Hoor, D. , Moehler, K. , and Natterer, J. (1989). *Timber design and construction source book: A comprehensive guide to methods and practice* . McGraw-Hill, New York.
- Hoyle, R. J. , and Woeste, F. E. (1989). *Wood technology in the design of structures* . Iowa State University Press, Ames.
- International Code Council (ICC). (2006). *ICC standard on the design and construction of log structures*, Third Draft . Country Club Hills, IL.
- Ishizuka, T. , and Hawkins, N. M. (1987). “Effect of bond deterioration on the seismic response of reinforced and partially prestressed concrete ductile moment resistant frames.” *Report SM 87-2* . Department of Civil Engineering, University of Washington, Seattle.
- Karacabeyli, E. , and Popovsky, M. (2003). *Design for earthquake resistance*. Timber engineering , H. Larsen , and S. Thelandersson , eds., John Wiley & Sons, New York.

- Keenan, F. J. (1986). *Limit states design of wood structures*. Morrison Hershfield, North York, Ontario.
- Koliou, M., Filiatrault, A., Kelly, D. J., & Lawson, J. (2016). “Buildings with rigid walls and flexible roof diaphragms. I: Evaluation of current U.S. seismic provisions.” *Journal of Structural Engineering*, 142(3)10.1061/(ASCE)ST.1943-541X.0001438
- Koliou, M., Filiatrault, A., Kelly, D. J., & Lawson, J. (2016b). “Buildings with rigid walls and flexible roof diaphragms. II: Evaluation of a new seismic design approach based on distributed diaphragm yielding.” *Journal of Structural Engineering*, 142(3)10.1061/(ASCE)ST.1943-541X.0001439
- Lee, N. H. , Kim, K. S. , Bang, C. J. , and Park, K. R. (2007). “Tensile-headed anchors with large diameter and deep embedment in concrete.” *ACI Struct. J.* , 104(4), 479–486.
- Lee, N. H. , Park, K. R. , and Suh, Y. P. (2010). “Shear behavior of headed anchors with large diameters and deep embedments.” *ACI Struct. J.* , 107(2), 146–156.
- Masonry Standards Joint Committee (MSJC). (1999). “Building code requirements for masonry structures.” *ACI 530-99/ASCE 5-99/TMS 402-99* , “Specification for masonry structures”; *ACI 530.1-99/ASCE 6-99/TMS 602-99* , “Commentary on building code requirements for masonry structures, commentary on specification for masonry structures,” known as *MSJC standards (code and specification)*, The Masonry Society, Boulder, CO, American Concrete Institute, Farmington Hills, MI, ASCE, Reston, VA.
- Nakaki, S. D. , Stanton, J. F. , and Sritharan, S. (1999). “An overview of the PRESSS five-story precast test building.” *PCI J.* , 44(2), 26–39.
- NBM. (2017). *Cyclic performance and characterization of steel deck connections*, NBM Technologies report to AISI/SDI/SJI, 14 December 2017
- NBM. (2018). “Button punch sidelaps (Cyclic testing program).” *NUCOR-Verco/Vulcraft Group, Project number 103-042-18*, 11 July 2018 (released by Verco for public use)
- O'Brien, P., Eatherton, M.R., Easterling, W.S. (2017). “Characterizing the load-deformation behavior of steel deck diaphragms using past test data.” *CFSRC Report 2017-02*. access at <http://jhir.library.jhu.edu/handle/1774.2/40633>
- Park, R. , and Thompson, K. J. (1977). “Cyclic load tests on prestressed and partially prestressed beam-column joints.” *PCI J.* , 22(5), 84–110.
- Schafer, B.W. (2019). “Research on the seismic performance of rigid wall flexible diaphragm buildings with bare steel deck diaphragms.” *CFSRC Report R-2019-02*.
- SDI (2015) *Diaphragm design manual, 4th Ed.*, Steel Deck Institute (also known as DDM04).
- SDI (2016) *Manual of construction with steel deck, 3rd Ed.*, Steel Deck Institute.
- SDI (2017) “Quality control and quality assurance for installation of steel deck.” *ANSI/SDI QA/QC-2017* Standard. Steel Deck Institute.
- Sherwood, G. E. , and Stroh, R. C. (1989). *Wood-frame house construction*. Agricultural handbook 73, U.S. Government Printing Office, Washington, DC.
- Somayaji, Shan. (1992). *Structural wood design*. West Publishing Co., St. Paul, MN.
- Stalnaker, J. J. , and Harris, E. C. (1996). *Structural design in wood*, 2nd Ed., McGraw-Hill, New York.
- Structural Engineers Association of California (SEAOC). (1999). *Recommended lateral force requirements and commentary*. SEAOC, Sacramento, CA.
- Structural Engineers Association of Northern California (SEAONC). (2005). *Guidelines for seismic evaluation and rehabilitation of tilt-up buildings and other rigid wall/flexible diaphragm structures*. SEAONC, Sacramento, CA.

U.S. Department of Agriculture, National Oceanic and Atmospheric Administration. (1971). San Fernando, California, Earthquake of February 9, 1971. NOAA, Washington, DC.

U.S. Department of the Army, Navy, and Air Force. (1992). "Seismic design for buildings." *TM5-809-10* (Tri-Services Manual). U.S. Government Printing Office, Washington, DC.

Wei, G., Eatherton, M.R., Schafer, B.W. (2019). "Development of steel deck diaphragm seismic design provisions for ASCE 41/AISC 342." *CFSRC Report R-2019-01*. <http://jhir.library.jhu.edu/handle/1774.2/59927>

Page intentionally left blank.

COMMENTARY TO CHAPTER 15, SEISMIC DESIGN REQUIREMENTS FOR NONBUILDING STRUCTURES

C15.1 GENERAL

C15.1.1 Nonbuilding Structures

Building codes traditionally have been perceived as minimum standards for the design of nonbuilding structures, and building code compliance of these structures is required by building officials in many jurisdictions. However, requirements in the industry reference documents are often at odds with building code requirements. In some cases, the industry documents need to be altered, whereas in other cases, the building codes need to be modified. Registered design professionals are not always aware of the numerous accepted documents within an industry and may not know whether the accepted documents are adequate. One of the intents of Chapter 15 of the standard is to bridge the gap between building codes and existing industry reference documents.

Differences between the ASCE/SEI 7 design approaches for buildings and industry document requirements for steel multilegged water towers (Figure C15.1-1) are representative of this inconsistency. Historically, such towers have performed well when properly designed in accordance with American Water Works Association (AWWA) standards and industry practices. Those standards and practices differ from the ASCE/SEI 7 treatment of buildings in that tension-only rods are allowed, upset rods are preloaded at the time of installation, and connection forces are not amplified.



FIGURE C15.1-1 Steel multilegged water tower

Source: Courtesy of CB&I LLC; reproduced with permission.

Chapter 15 also provides an appropriate link so that the industry reference documents can be used with the seismic ground motions established in the standard. Some nonbuilding structures are similar to buildings and can be designed using sections of the standard directly, whereas other nonbuilding structures require special analysis unique to the particular type of nonbuilding structure.

Building structures, vehicular bridges, electrical transmission towers, hydraulic structures (e.g., dams), buried utility lines and their appurtenances, and nuclear reactors are excluded from the scope of the nonbuilding structure requirements, although industrial buildings are permitted per Chapter 11 to use the provisions in Chapter 15 for nonbuilding structures with structural systems similar to buildings, provided

that specific conditions are met. The excluded structures are covered by other well-established design criteria (e.g., electrical transmission towers and vehicular bridges), are not under the jurisdiction of local building officials (e.g., nuclear reactors and dams), or require technical considerations beyond the scope of the standard (e.g., buried utility lines and their appurtenances).

C15.1.2 Design.

Nonbuilding structures and building structures have much in common with respect to design intent and expected performance, but there are also important differences. Chapter 15 relies on other portions of the standard where possible and provides special notes where necessary.

There are two types of nonbuilding structures: those with structural systems similar to buildings and those with structural systems not similar to buildings. Specific requirements for these two cases appear in Sections 15.5 and 15.6.

C15.1.3 Structural Analysis Procedure Selection.

Nonbuilding structures that are similar to buildings are subject to the same analysis procedure limitations as building structures. Nonbuilding structures that are not similar to buildings are subject to those limitations and are subject to procedure limitations prescribed in applicable specific reference documents.

For many nonbuilding structures supporting flexible system components, such as pipe racks (Figure C15.1-2), the supported piping and platforms generally are not regarded as rigid enough to redistribute seismic forces to the supporting frames.



FIGURE C15.1-2 Steel pipe rack

Source: Courtesy of CB&I LLC; reproduced with permission.

For nonbuilding structures supporting very stiff (i.e., rigid) system components, such as steam turbine generators (STGs) and heat recovery steam generators (HRSGs) (Figure C15.1-3), the supported equipment, ductwork, and other components (depending on how they are attached to the structure) may be rigid enough to redistribute seismic forces to the supporting frames. Torsional effects may need to be considered in such situations.



FIGURE C15.1-3 Heat recovery steam generators

Source: Courtesy of CB&I LLC; reproduced with permission.

Section 12.6 presents seismic analysis procedures for building structures based on the Seismic Design Category (SDC); the fundamental period, T ; and the presence of certain horizontal or vertical irregularities in the structural system. Where the fundamental period is greater than or equal to $3.5 T_s$ (where $T_s = S_{D1} / S_{DS}$), the use of the equivalent lateral force procedure is not permitted in SDCs D, E, and F. This requirement is based on the fact that, unlike the dominance of the first mode response in case of buildings with lower first mode period, higher vibration modes do contribute more significantly in situations when the first mode period is larger than $3.5 T_s$. For buildings that exhibit classic flexural deformation patterns (such as slender shear-wall or braced-frame systems), the second mode frequency is at least 3.5 times the first mode frequency, so where the fundamental period exceeds $3.5 T_s$, the higher modes have larger contributions to the total response because they occur near the peak of the design response spectrum.

It follows that dynamic analysis (modal response spectrum analysis or response history analysis) may be necessary to properly evaluate buildinglike nonbuilding structures if the first mode period is larger than $3.5 T_s$ and the equivalent lateral force analysis is sufficient for nonbuilding structures that respond as single-degree-of-freedom systems.

The recommendations for nonbuilding structures provided in the following are intended to supplement the designer's judgment and experience. The designer is given considerable latitude in selecting a suitable analysis method for nonbuilding structures.

Buildinglike Nonbuilding Structures. Table 12.6-1 is used in selecting analysis methods for buildinglike nonbuilding structures, but, as illustrated in the following three conditions, the relevance of key behavior must be considered carefully:

1. Irregularities: Table 12.6-1 requires dynamic analysis for SDC D, E, and F structures that have certain horizontal or vertical irregularities. Some of these building irregularities (defined in Section 12.3.2) are relevant to nonbuilding structures. The weak- and soft-story vertical irregularities (Types 1a, 1b, 4a, and 4b of Table 12.3-2) are pertinent to the behavior of buildinglike nonbuilding structures. Other vertical and horizontal irregularities may or may not be relevant, as described below.

- a. Horizontal irregularities: Horizontal irregularities of Types 1a and 1b affect the choice of analysis method, but these irregularities apply only where diaphragms are rigid or semirigid, and some buildinglike nonbuilding structures have either no diaphragms or flexible diaphragms.
 - b. Vertical irregularities: Vertical irregularity Type 3 addresses large differences in the horizontal dimension of the seismic force-resisting system in adjacent stories because the resulting stiffness distribution can produce a fundamental mode shape unlike that assumed in the development of the equivalent lateral force procedure. Because the concern relates to stiffness distribution, the horizontal dimension of the seismic force-resisting system, not of the overall structure, is important.
2. Arrangement of supported masses: Even where a nonbuilding structure has buildinglike appearance, it may not behave like a building, depending on how masses are attached. For example, the response of nonbuilding structures with suspended vessels and boilers cannot be determined reliably using the equivalent lateral force procedure because of the pendulum modes associated with the significant mass of the suspended components. The resulting pendulum modes, while potentially reducing story shears and base shear, may require large clearances to allow pendulum motion of the supported components and may produce excessive demands on attached piping. Dynamic analysis is highly recommended in such cases, with consideration for appropriate impact forces in the absence of adequate clearances.
 3. Relative rigidity of beams: Even where a classic building model may seem appropriate, the equivalent lateral force procedure may underpredict the total response if the beams are flexible relative to the columns (of moment frames) or the braces (of braced frames). This underprediction occurs because higher modes associated with beam flexure may contribute more significantly to the total response (even if the first mode response is at a period less than $3.5T_s$). This situation of flexible beams can be especially pronounced for nonbuilding structures because the “normal” floors common to buildings may be absent. Therefore, the dynamic analysis procedures are suggested for buildinglike nonbuilding structures with flexible beams.

Nonbuilding Structures Not Similar to Buildings. The (static) equivalent lateral force procedure is based on classic building dynamic behavior, which differs from the behavior of many nonbuilding structures not similar to buildings. As discussed below, several issues should be considered for selecting either an appropriate method of dynamic analysis or a suitable distribution of lateral forces for static analysis.

1. Structural geometry: The dynamic response of nonbuilding structures with a fixed base and a relatively uniform distribution of mass and stiffness, such as bottom-supported vertical vessels, stacks, and chimneys, can be represented adequately by a cantilever (shear building) model. For these structures, the equivalent lateral force procedure provided in the standard is suitable. This procedure treats the dynamic response as being dominated by the first mode. In such cases, it is necessary to identify the first mode shape (using, for instance, the Rayleigh–Ritz method or other classical methods from the literature) for distribution of the dynamic forces. For some structures, such as tanks with low height-to-diameter ratios storing granular solids, it is conservative to assume a uniform distribution of forces. Dynamic analysis is recommended for structures that have neither a uniform distribution of mass and stiffness nor an easily determined first mode shape.
2. Number of lateral supports: Cantilever models are obviously unsuitable for structures with multiple supports. Figure C15.1-4a shows a nonbuilding braced frame structure that provides nonuniform horizontal support to a piece of equipment. In such cases, the analysis should include coupled model effects. For such structures, an application of the equivalent lateral force method could be used, depending on the number and locations of the supports. For example, most beam-type configurations lend themselves to application of the equivalent lateral force method. For adjacent nonbuilding structures connected by nonstructural components (Fig 15.1-4b), a combined dynamic analysis may be required as indicated in Sections 15.2.1.

3. Method of supporting dead weight: Certain nonbuilding structures (such as power boilers) are supported from the top. They may be idealized as pendulums with uniform mass distribution. In contrast, a suspended platform may be idealized as a classic pendulum with concentrated mass. In either case, these types of nonbuilding structures can be analyzed adequately using the equivalent lateral force method by calculating the appropriate frequency and mode shape. Figure C15.1-5 shows a nonbuilding structure containing lug-supported equipment with W_p greater than 0.20 ($W_s + W_p$). In such cases, the analysis should include a coupled system with the mass of the equipment and the local flexibility of the supports considered in the model. Where the support is located near the nonbuilding structure's vertical location of the center of mass, a dynamic analysis is recommended.
4. Torsional irregularities: Structures in which the fundamental mode of response is torsional or in which modes with significant mass participation exhibit a prominent torsional component may also have inertial force distributions that are significantly different from those predicted by the equivalent lateral force method. In such cases, dynamic analyses should be considered. Figure C15.1-7 illustrates one such case where a vertical vessel is attached to a secondary vessel with W_2 greater than about 0.20 ($W_1 + W_2$).
5. Stiffness and strength irregularities: Just as for buildinglike nonbuilding structures, abrupt changes in the distribution of stiffness or strength in a nonbuilding structure not similar to buildings can result in substantially different inertial forces from those indicated by the equivalent lateral force method. Figure C15.1-8 represents one such case. For structures that have such configurations, consideration should be given to the use of dynamic analysis procedures. Even where dynamic analysis is required, the standard does not define in any detail the degree of modeling; an adequate model may have a few dynamic degrees of freedom or tens of thousands of dynamic degrees of freedom. The important point is that the model captures the significant dynamic response features so that the resulting lateral force distribution is valid for design. The designer is responsible for determining whether dynamic analysis is warranted and, if so, the degree of detail required to address adequately the seismic performance.
6. Coupled response: Where the weight of the supported structure is large compared with the weight of the supporting structure, the combined response can be affected significantly by the flexibility of the supported nonbuilding structure. In that case, dynamic analysis of the coupled system is recommended. Examples of such structures are shown in Figure C15.1-8. Part (a) shows a flexible nonbuilding structure with W_p greater than $0.25(W_s + W_p)$, supported by a relatively flexible structure; the flexibility of the supports and attachments should be considered. Part (b) shows flexible equipment connected by a large-diameter, thick-walled pipe and supported by a flexible structure; the structures should be modeled as a coupled system including the pipe.

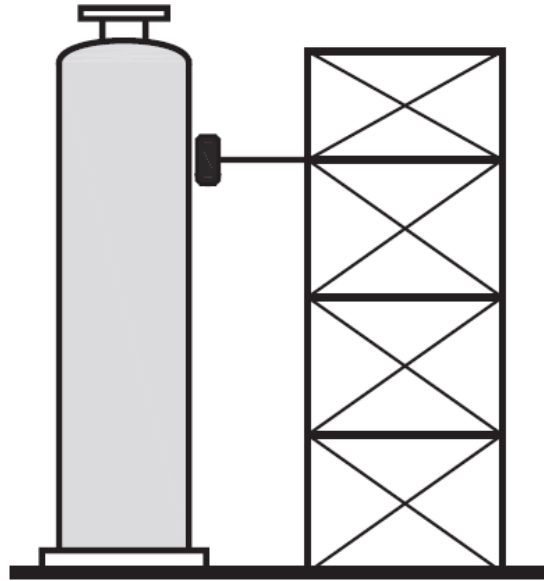

FIGURE C15.1-4a Multiple lateral supports

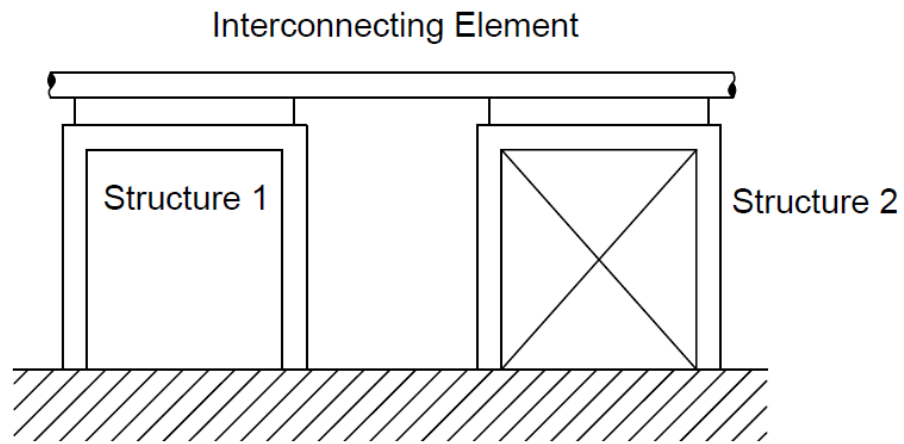

FIGURE C15.1-4b adjacent nonbuilding structures connected by nonstructural components

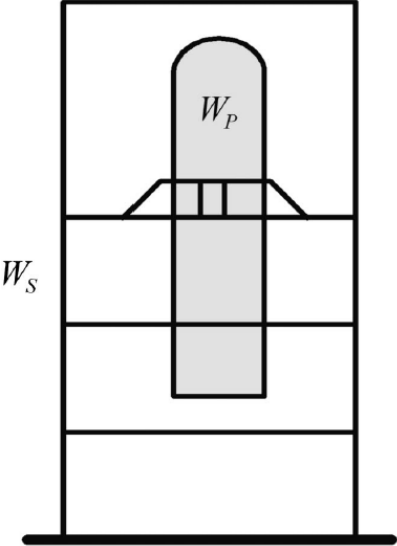

FIGURE C15.1-5 Unusual support of dead weight

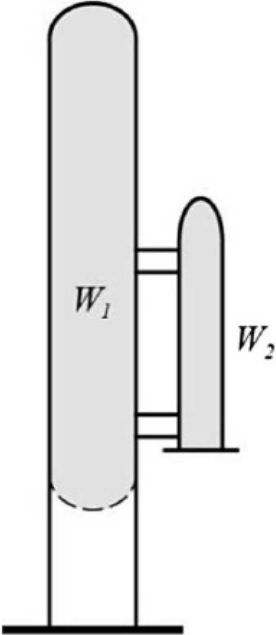

FIGURE C15.1-6 Torsional irregularity

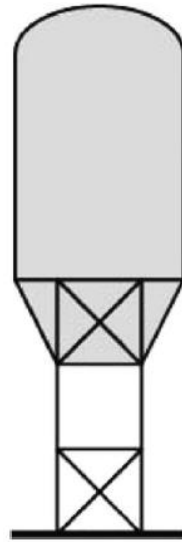

FIGURE C15.1-7 Soft-story irregularity

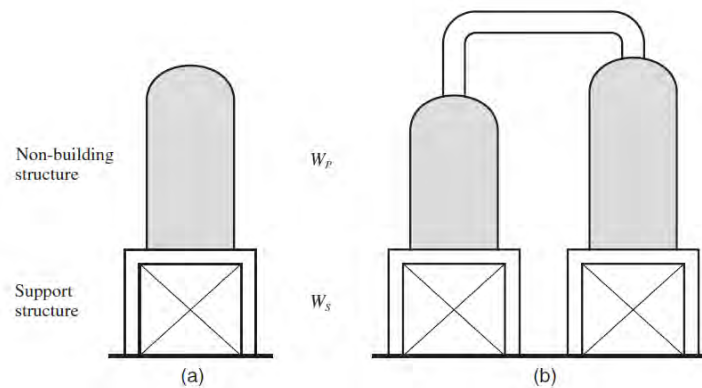

FIGURE C15.1-8 Couple system

Distributed mass cantilever structures have over several cycles of ASCE 7 had their R values reduced and/or special detailing requirements added to improve their performance. The exceptions to the modal scaling rules of Section 12.9 listed in Section 15.1.3 for distributed mass cantilever structures recognize this improvement in performance.

C15.1.4 Nonbuilding Structures Sensitive to Vertical Ground Motions.

Traditionally, ASCE 7 did not provide guidance to address designing for a separate vertical ground motion. Historically, this omission has not been a problem for buildings because there is inherent strength in the vertical direction because of the margin that is developed when the dead load and live load are applied. However, this is not necessarily the case for nonbuilding structures. Many nonbuilding structures are sensitive to vertical motions and do not have the benefit of the inherent strength that exists in buildings. Examples of some structures are liquid and granular storage tanks or vessels, suspended structures (such as boilers), and nonbuilding structures incorporating horizontal cantilevers. Such structures are required to incorporate Section 11.9 into the design of the structure in lieu of applying the traditional vertical ground motion of $0.2S_{DS}$.

C15.2 NONBUILDING STRUCTURES CONNECTED BY NONSTRUCTURAL COMPONENTS TO OTHER ADJACENT STRUCTURES

C15.2.1 Nonbuilding Structures Connected by Nonstructural Components to Other Adjacent Structures.

The ASCE 7-22 edition of this standard added coupled analysis requirements for adjacent structures that are connected by nonstructural components to other adjacent structures. This scenario commonly occurs in the case of industrial structures such as piperacks and equipment structures. Prior to this edition of the standard, little guidance has been given on the design of adjacent structures connected by nonstructural components. Work by Wey & Mejia (2019) proposed decoupling triggers based on the fundamental periods of the connected structures and the stiffness of the interconnecting elements. The use of fundamental periods as decoupling triggers follows similar reasoning as the work of Hadjian & Ellison (1986).

Nonstructural components spanning between structures that have a small stiffness compared to the stiffnesses of both the nonbuilding and adjacent structures do not significantly alter the fundamental periods of the connected structures. Therefore, when the stiffness of the interconnecting element in the direction of motion is small compared to the nonbuilding and adjacent structures, the adjacent structures can be designed independently, without needing to consider the structural characteristics of the nonstructural components. Electrical cable trays, small-bore piping, and light platforming are examples of nonstructural components that can be considered flexible with respect to the supporting structures. Typical platform support members with significant axial stiffness in the direction of motion have either slotted or sliding connections at one end in order to minimize the transfer of seismic loading. An additional intent of this provision is to encourage the use of detailing and devices, such as slide plates and expansion joints, that work to reduce the stiffness of the connecting element in the direction of motion.

As the connecting nonstructural component stiffness increases, coupling effects become more pronounced, and the fundamental period of the combined structure tends to dominate the seismic response. When structures with similar dynamic characteristics in the direction of motion are connected by stiff elements, the resulting fundamental period of the combined system will fall between the fundamental periods of the independently analyzed structures. As a result interconnected structures with similar dynamic characteristics in the direction of motion will tend to behave similarly when connected by stiff components, provided that ground motions are sufficiently uniform. Large bore pipe, thick-walled ductwork, and large mechanical equipment are examples of nonstructural components that can be considered rigid with respect to the supporting structures.

Due to the complex nature of irregular structures, it follows that presence of horizontal and vertical irregularities, such as those shown in Section C15.1.3, can lead to inaccuracies in the magnitude and distribution of the resulting lateral forces. The designer should acknowledge that, in such scenarios, there is limited applicability to the coupling exceptions provided in this section and is responsible for accounting for the combined behavior of the connected structures.

The exceptions only apply to structures with vertical mass and stiffness regularity with similar fundamental periods. Figure C15.2-1 (a stack connected with a supported tank by large duct work) provides an example where the exceptions do not apply. The tank support structure has both mass and soft-story irregularities (see Figures C15.1-6 and C15.1-8). Connection of the duct work to the tank support introduces an additional stiffness irregularity to the structure. Design of the structures shown in Figure C15.2-1 requires a coupled analysis.

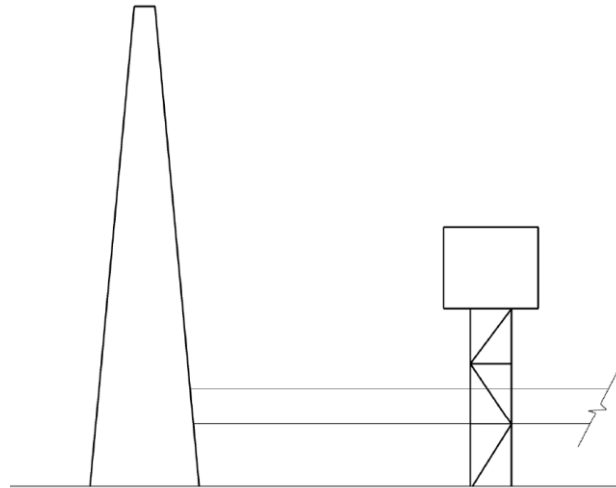

Figure C15.2-1 Stack connected to tower by large duct

C15.2.2 Architectural, Mechanical, and Electrical Components Spanning Between Nonbuilding Structures.

Nonstructural components spanning between structures, depending on how they are attached to the supporting structures, may be rigid enough to redistribute seismic forces between structures. The rigidity of the interconnecting elements and any possible interaction due to out of phase motion between structures may result in significant induced forces and displacements. Design of nonstructural components for these seismic demands requires careful consideration of the relative forces and displacements acting on the nonstructural component in any direction including out-of-phase motion, as illustrated in Figure C13.3-5, and shall be compatible with the assumptions used to define the effective component stiffness in the direction of motion. The design of such components and their anchorage should incorporate the requirements set forth in Chapter 13, regardless of whether the connected structures are analyzed independently as allowed by the exceptions in Section 15.2.1.

C15.3 NONBUILDING STRUCTURES SUPPORTED BY OTHER STRUCTURES

There are instances where nonbuilding structures not similar to buildings are supported by other structures or other nonbuilding structures. This section specifies how the seismic design loads for such structures are to be determined and the detailing requirements that are to be satisfied in the design.

C15.3.1 Supported Nonbuilding Structures with Less Than 20% Combined Weight.

In many instances, the weight of the supported nonbuilding structure is relatively small compared with the weight of the supporting structure, such that the supported nonbuilding structure has a relatively small effect on the overall nonlinear earthquake response of the primary structure during design-level ground motions. It is permitted to treat such structures as nonstructural components and to use the requirements of Chapter 13 for their design. The ratio of secondary component weight to total weight of 20% at which this treatment is permitted was not originally documented in any commentary but appears to be based on judgment and the work of Hadjian (1986). Figure C15.3-1 shows the decoupling criteria originally proposed by Hadjian (1986). Combinations of frequency ratio and mass ratio falling to the left of the curve shown in Figure C15.3-1 would be exempt from a coupled analysis. Other lines shown in Figure C15.3-1 denoted by RTD, Lin, and NRC represent other exemption criteria in use when the work of Hadjian (1986) was originally published. The original triggering ratio of 25%, now revised to 20%, was introduced into code provisions in the 1988 *Uniform Building Code* by the SEAOC Seismology Committee. The original proposal was based on consideration of the ratio of secondary component weight to weight of the supporting

structure (not explicitly including the component weight) and a single point of attachment, whereby multiple closely spaced attachments can be represented as a single point of attachment. In ASCE 7-02, the weight, W , was amended to reflect the total weight of component and supporting structure, but the 25% limit remained unchanged. ASCE 7-22 revised the triggering ratio downward to 20% to be in better alignment with the original research of Hadjian (1986). Analytical studies, typically based on linear elastic primary and secondary structures, support a lower triggering ratio, but the SEAOC Seismology Committee judged that the 20% ratio is appropriate where primary and secondary structures exhibit nonlinear behavior, as this will tend lessen the effects of resonance and interaction. Therefore, a vertical line, originally set at a mass ratio of 25% but now revised to 20%, was used instead of the curve shown in Figure C15.3-1 to determine when a coupled analysis was required. The 20% ratio also reflects a 15% tolerance error on frequency. In cases where a nonbuilding structure (or nonstructural component) is supported by another structure, it may be appropriate to analyze in a single model. In such cases, it is intended that seismic design loads and detailing requirements be determined following the procedures of Section 15.3.2. Where there are multiple large nonbuilding structures, such as vessels supported on a primary nonbuilding structure, and the weight of an individual supported nonbuilding structure does not exceed the 20% limit but the combined weight of the supported nonbuilding structures does, it is recommended that the combined analysis and design approach of Section 15.3.2 be used. It is also suggested that dynamic analysis be performed in such cases because the equivalent lateral force procedure may not capture some important response effects in some members of the supporting structure.

Where the weight of the supported nonbuilding structure does not exceed the 20% limit and a combined analysis is performed, the following procedure should be used to determine the F_p force of the supported nonbuilding structure based on Eq. (13.3-4):

1. A modal analysis should be performed in accordance with Section 12.9 as modified by Section 15.1.3.
2. For a component supported at level i , the acceleration at that level should be taken as a_i , the total shear just below level i divided by the seismic weight at and above level i .
3. The elastic value of the component shear force coefficient should next be determined as the shear force from the modal analysis at the point of attachment of the component to the structure divided by the weight of the component. This value is preliminarily taken as $a_i a_p$. Because a_p cannot be taken as less than 1.0, the value of a_p is taken as $a_i a_p / a_i$, except that the final value a_p need not be taken as greater than 2.5 and should not be taken as less than 1.0. The final value of $a_i a_p$ should be the final value of a_i determined in step 2 multiplied by the final value of a_p determined earlier in this step.
4. The resulting value of $a_i a_p$ should be used in Eq. (13.3-4); the resulting value of F_p is subject to the maximum and minimum values of Eqs. (13.3-2) and (13.3-3), respectively.

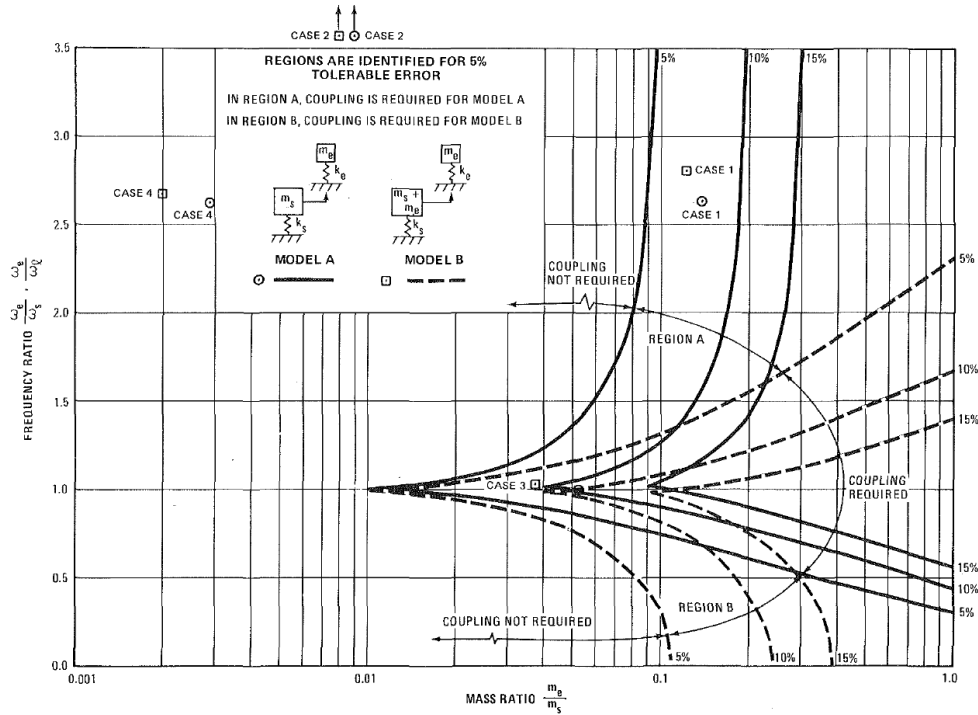

Figure C15.3-1 Decoupling Criteria from Hadjian & Ellison (1986).

C15.3.2 Supported Nonbuilding Structures with Greater Than or Equal to 20% Combined Weight.

Where the weight of the supported structure is relatively large compared with the weight of the supporting structure, the overall response can be affected significantly. Previously, the standard sets forth two analysis approaches, depending on the rigidity of the nonbuilding structure. The determination of what was deemed rigid or flexible was based on the same criteria used for nonstructural components. Few if any nonbuilding structures with weights greater than or equal to 20% of the total weight are rigid. Therefore, the case where the supported nonbuilding structure is rigid has been removed from the standard. Instead, exceptions have been added in this standard introducing new decoupling criteria for nonbuilding structures that are sufficiently detuned (that is, where the fundamental period of the supporting structure, including the lumped weight of the nonbuilding structure, is sufficiently small or large compared nonbuilding structure). These criteria follow work initially performed by Hadjian & Ellison (1986) with specific detuning thresholds proposed by Wey & Mejia (2019). The criteria is in line with current seismic design practice of industrial structures, such as steel vertical vessels supported on concrete table-tops, where the concrete structure’s fundamental period is calculated including the lumped weight of the steel vessel, and the structure is designed without knowledge of the structural characteristics of the supported vessel. This standard permits, in situations when the fundamental period of the nonbuilding structure is more than twice of that of the supporting structure, the nonbuilding structure to be modeled as attached to a rigid base.

A combined model of the supporting structure and the supported nonbuilding structure is now used in all cases unless allowed by the exceptions of Section 15.3.2. The design loads and detailing are determined based on the lower *R* value of the supported nonbuilding structure or supporting structure. The use of the lower *R* value of the supported nonbuilding structure or supporting structure is based on the rules for vertical combinations found in Section 12.2.3.1(2).

Although not specifically mentioned in Section 15.3.2, another approach is permitted. A nonlinear response history analysis of the combined system can be performed in accordance with Chapter 16, and the results can be used for the design of both the supported and supporting nonbuilding structures. This option should be considered where standard static and dynamic elastic analysis approaches may be inadequate to evaluate the earthquake response (such as for suspended boilers). This option should be used with extreme caution because modeling and interpretation of results require considerable judgment. Because of this sensitivity, Chapter 16 requires independent design review.

C15.4 STRUCTURAL DESIGN REQUIREMENTS

This section specifies the basic coefficients and minimum design forces to be used to determine seismic design loads for nonbuilding structures. It also specifies height limits and restrictions. As with building structures, it presumes that the first step in establishing the design forces is to determine the design base shear for the structure.

There are two types of nonbuilding structures: those with structural systems similar to buildings and those with structural systems not similar to buildings. Specific requirements for these two cases appear in Sections 15.5 and 15.6.

Table 15.4-1 contains the response modification coefficient (R) for nonbuilding structures similar to buildings. Table 15.4-2 contains the response modification coefficient for nonbuilding structures not similar to buildings. Every response modification coefficient has associated design and detailing requirements to ensure the required ductility associated with that response modification coefficient value (e.g., AISC 341). Some structures, such as pipe racks, do not resemble a traditional building in that they do not house people or have such things as walls and bathrooms. These structures have lateral force-resisting systems composed of braced frames and moment frames similar to a traditional building. Therefore, pipe racks are considered nonbuilding structures similar to buildings. The response modification coefficient for a pipe rack should be taken from Table 15.4-1 for the appropriate lateral force-resisting system used, and the braced frames and/or moment frames used must meet all of the design and detailing requirements associated with the R value selected (see Section 15.5.2, Pipe Racks).

Most major power distribution facility (power island) structures, such as HRSG support structures, steam turbine pedestals, coal boiler support structures, pipe racks, air inlet structures, and duct support structures, also resist lateral forces predominantly by use of buildinglike framing systems such as moment frames, braced frames, or cantilever column systems. Therefore, their response modification coefficient should be selected from Table 15.4-1, and they must meet all the design and detailing requirements associated with the response modification coefficient selected.

Many nonbuilding structures, such as flat-bottom tanks, silos, and stacks, do not use braced frames or moment frames similar to those found in buildings to resist seismic loads. Therefore, they have their own unique response modification coefficient, which can be found in Table 15.4-2.

For nonbuilding structures with lateral systems composed predominantly of buildinglike framing systems, such as moment frames, braced frames, or cantilever column systems, it would be inappropriate to extrapolate the descriptions in Table 15.4-2, resulting in inappropriately high response modification coefficients and the elimination of detailing requirements.

Once a response modification coefficient is selected from the tables, Section 15.4.1 provides additional guidance.

C15.4.1 Design Basis.

Separate tables provided in this section identify the basic coefficients, associated detailing requirements, and height limits and restrictions for the two types of nonbuilding structures.

For nonbuilding structures similar to buildings, the design seismic loads are determined using the same procedures used for buildings as specified in Chapter 12, with two exceptions: fundamental periods are determined in accordance with Section 15.4.4, and Table 15.4-1 provides additional options for structural systems. Although only Section 12.8 (the equivalent lateral force procedure) is specifically mentioned in Section 15.4.1, Section 15.1.3 provides the analysis procedures that are permitted for nonbuilding structures.

In Table 15.4-1, seismic coefficients, system restrictions, and height limits are specified for a few nonbuilding structures similar to buildings. The values of R , Ω_0 , and C_d ; the detailing requirement references; and the structural system height limits are the same as those in Table 12.2-1 for the same systems, except for ordinary moment frames. In Chapter 12, increased height limits for ordinary moment frame structural systems apply to metal building systems, whereas in Chapter 15 they apply to pipe racks with end plate bolted moment connections. The seismic performance of pipe racks was judged to be similar to that of metal building structures with end plate bolted moment connections, so the height limits were made the same as those specified in previous editions.

Table 15.4-1 also provides lower R values with less restrictive height limits in SDCs D, E, and F based on good performance in past earthquakes. For some options, no seismic detailing is required if very low values of R (and corresponding high seismic design forces) are used. The concept of extending this approach to other structural systems is the subject of future research using the methodology developed in FEMA P-695 (FEMA 2009).

For nonbuilding structures not similar to buildings, the seismic design loads are determined as in Chapter 12 with three exceptions: the fundamental periods are determined in accordance with Section 15.4.4, the minima are those specified in Section 15.4.1(2), and the seismic coefficients are those specified in Table 15.4-2.

Some entries in Table 15.4-2 may seem to be conflicting or confusing. For example, the first major entry is for elevated tanks, vessels, bins, or hoppers. A subset of this entry is for tanks on braced or unbraced legs. This subentry is intended for structures where the supporting columns are integral with the shell (such as an elevated water tank). Tension-only bracing is allowed for such a structure. Where the tank or vessel is supported by buildinglike frames, the frames are to be designed in accordance with all of the restrictions normally applied to building frames. Section 15.3 provides provisions for nonbuilding structures supported by buildinglike frames. Beginning with the 2005 edition of ASCE 7, Table 15.4-2 contained an entry for "Tanks or vessels supported on structural towers similar to buildings." Under certain circumstances, text provided with this table entry conflicted with the requirements of Section 15.3. If the weight of the nonbuilding structure is relatively small compared to the weight of the structure (less than 25% of the weight of the structure) or the nonbuilding structure is rigid, the supported nonbuilding structure can be treated as a nonstructural component and the values of the supporting structure seismic coefficients can be taken from Table 15.4-1. Under these circumstances, the deleted entry was correct. However, if the weight of the supported nonbuilding structure is not small and the nonbuilding structure is flexible (which is generally the case especially when you consider the vertical and rocking flexibility of supporting floor beams), the seismic coefficients are determined as the most conservative.

The accidental torsion requirements of Section 12.8.4.2 were formulated primarily for use in building structures. The primary factors that contribute to accidental torsion are lateral force-resisting systems that are located primarily near the center of the structure rather than the perimeter, disproportionate concentration of inelastic demands in system components, the effects of nonstructural elements, uncertainties in defining the structure's stiffness characteristics, and spatial variation (and rotational components of ground motions) of horizontal input motions applied to long structures. Inherently torsionally resistant systems as defined in Section 15.4.1, Item 5, with R values less than or equal to 3.5 are not expected to have inelastic demands of a level that would require additional consideration of accidental torsion. Additionally, nonbuilding structures rarely contain significant nonstructural elements

that are not accounted for explicitly in the design of these structures and typically have very well-known mass and stiffness characteristics. Nonbuilding structures also rarely, if ever, have their lateral force-resisting systems located at the center of the structure in plan rather than at the perimeter. The requirement that the calculated center of rigidity at each diaphragm is greater than 5% of the plan dimension of the diaphragm in each direction from the calculated center of mass of the diaphragm prevents configurations of lateral force-resisting elements that are inherently susceptible to the effects of torsion from being exempted from the effects of accidental torsion. Spatial variations of ground motions should be considered in the design of structures of considerable length. If there are significant variations between full and empty weights of the structure, the inherent torsion caused by these variations should be considered in the design of the structure. If there is a nonuniform distribution of mass in silos or bins storing bulk materials because of multiple filling or discharge points, multiple hoppers, nonuniform funnel flow, bulk material behavior, or other operational considerations, the inherent torsion caused by these conditions should be considered in the design of the silo or bin.

C15.4.1.1 Importance Factor.

The Importance Factor for a nonbuilding structure is based on the risk category defined in Chapter 1 of the standard or the building code being used in conjunction with the standard. In some cases, reference standards provide a higher Importance Factor, in which case the higher Importance Factor is used.

If the Importance Factor is taken as 1.0 based on a hazard and operability (HAZOP) analysis performed in accordance with Chapter 1, the third paragraph of Section 1.5.3 requires careful consideration; worst-case scenarios (instantaneous release of a vessel or piping system) must be considered. HAZOP risk analysis consultants often do not make such assumptions, so the design professional should review the HAZOP analysis with the HAZOP consultant to confirm that such assumptions have been made to validate adjustment of the Importance Factor. Clients may not be aware that HAZOP consultants do not normally consider the worst-case scenario of instantaneous release but tend to focus on other, more hypothetical, limited-release scenarios, such as those associated with a 2-in.^2 ($1,290\text{ mm}^2$) hole in a tank or vessel.

C15.4.2 Rigid Nonbuilding Structures.

The definition of rigid (having a natural period of less than 0.06 s) was selected judgmentally. Below that period, the energy content of seismic ground motion is generally believed to be very low, and therefore the building response is not likely to be excessively amplified. Also, it is unlikely that any building will have a first mode period as low as 0.06 s, and it is even unusual for a second mode period to be that low. Thus, the likelihood of either resonant behavior or excessive amplification becomes quite small for equipment that has periods below 0.06 s.

The analysis to determine the period of the nonbuilding structure should include the flexibility of the soil subgrade.

C15.4.3 Loads.

As for buildings, the seismic weight must include the range of design operating weight of permanent equipment.

C15.4.4 Fundamental Period.

A significant difference between building structures and nonbuilding structures is that the approximate period formulas and limits of Section 12.8.2.1 may not be used for nonbuilding structures. In lieu of calculating a specific period for a nonbuilding structure for determining seismic lateral forces, it is of course conservative to assume a period of $T = T_s$, which results in the largest lateral design forces. Computing the fundamental period is not considered a significant burden because most commonly used computer analysis programs can perform the required calculations.

C15.4.7 Drift, Deflection, and Structure Separation.

Nonbuilding structure drifts, deflection, and structure separation are calculated using strength design factored load combinations in order to be compatible with the seismic load definition and the definition of the C_d factors. This philosophy is consistent with that of drift, deflections, and structure separation for buildings defined in Chapter 12.

C15.4.8 Site-Specific Response Spectra.

Where site-specific response spectra are required, they should be developed in accordance with Chapter 21 of the standard. If determined for other recurrence intervals, Section 21.1 applies, but Sections 21.2 through 21.4 apply only to risk-targeted maximum considered earthquake (MCE_R) determinations. Where other recurrence intervals are used, it should be demonstrated that the requirements of Chapter 15 also are satisfied.

C15.4.9 Anchors in Concrete or Masonry.

Many nonbuilding structures rely on the ductile behavior of anchor bolts to justify the response modification factor, R , assigned to the structure. Nonbuilding structures typically rely more heavily on anchorage to provide system ductility. The additional requirements of Section 15.4.9 provide additional anchorage strength and ductility to support the response modification factors assigned to these systems. The addition of Section 15.4.9 provides a consistent treatment of anchorage for nonbuilding structures.

C15.4.9.4 ASTM F1554 Anchors.

ASTM F1554 contains a requirement that is not consistent with the anchor requirements found in Chapter 15. Section 6.4 of ASTM F1554 allows the anchor supplier to substitute weldable Grade 55 anchors for Grade 36 anchors without the approval of the registered design professional. Because many nonbuilding structures rely on the ability of the anchors to stretch to justify the response modification factor, R , assigned to the structure, a higher yield anchor cannot be allowed to be substituted for a lower yield anchor without the approval of the registered design professional. Except where anchors are specified and are designed as ductile steel anchors in accordance with ACI 318, Section 17.2.3.4.3(a), or where the design must meet the requirements of Section 15.7.5 or Section 15.7.11.7b, this provision does not prohibit ductility from being provided by another element of the structure. In that case, the ASTM F1554 anchors would be designed for the corresponding forces.

C15.4.10 Requirements for Nonbuilding Structure Foundations on Liquefiable Sites.

Section 12.13.9 allows shallow foundation to be built on liquefiable soils with a number of restrictions. Many nonbuilding structures are sensitive to large foundation settlements. This sensitivity is caused by restraint imposed by interconnecting piping and equipment and the buckling sensitivity of shell structures. Therefore, in order to build these structures on shallow foundations on liquefiable soils, it must be demonstrated that the foundation, nonbuilding structure not similar to buildings, and connecting systems can be designed for the soil strength loss, the anticipated settlements from lateral spreading, and total and differential settlements induced by MCE_G earthquake ground motions.

C15.5 NONBUILDING STRUCTURES SIMILAR TO BUILDINGS

C15.5.1 General.

Although certain nonbuilding structures exhibit behavior similar to that of building structures, their functions and occupancies are different. Section 15.5 of the standard addresses the differences.

C15.5.2 Pipe Racks.

Freestanding pipe racks supported at or below grade with framing systems that are similar to building systems are designed in accordance with Section 12.8 or 12.9 and Section 15.4. Single-column pipe racks that resist lateral loads should be designed as inverted pendulums.

Based on good performance in past earthquakes, Table 15.4-1 sets forth the option of lower R values and less restrictive height limits for structural systems commonly used in pipe racks. The R value versus height limit tradeoff recognizes that the size of some nonbuilding structures is determined by factors other than traditional loadings and results in structures that are much stronger than required for seismic loadings. Therefore, the ductility demand is generally much lower than that for a corresponding building. The intent is to obtain the same structural performance at the increased heights. This option proves to be economical in most situations because of the relative cost of materials and construction labor. The lower R values and increased height limits of Table 15.4-1 apply to nonbuilding structures similar to buildings; they cannot be applied to building structures. Table C15.5-1 illustrates the R values and height limits for a 70-ft (21.3-m) high steel ordinary moment frame (OMF) pipe rack.

Table C15.5-1 Value Selection Example for Steel OMF Pipe Racks

Seismic Design Category		ASCE/SEI 7-10 Table	System	Seismic Detailing Requirements
C	3.5	12.2-1 or 15.4-1	Steel ordinary moment frame (OMF)	AISC 341
C	3	12.2-1	Structural steel systems not specifically detailed for seismic resistance	None
D or E	2.5	15.4-1	Steel OMF with permitted height increase	AISC 341
D, E, or F	1	15.4-1	Steel OMF with unlimited height	AISC 341

C15.5.3.1 Steel Storage Racks.

The two approaches to the design of steel storage racks set forth by the standard are intended to produce comparable results. The specific revisions to the Rack Manufacturers Institute (RMI) specification cited in earlier editions of this standard and the detailed requirements of the ANSI/RMI MH 16.1 specification reflect the recommendations of FEMA 460 (FEMA 2005).

Although the ANSI/RMI MH 16.1 specification reflects the recommendations of FEMA 460 (FEMA 2005), the anchorage provisions of the ANSI/RMI MH 16.1 specification are not in conformance with ASCE/SEI 7. Therefore, specific anchorage requirements were added in Sections 15.5.3.1.1 and 15.5.3.1.2.

These recommendations address the concern that storage racks in warehouse-type retail stores may pose a greater seismic risk to the general public than exists in low-occupancy warehouses or more conventional retail environments. Under normal conditions, retail stores have a far higher occupant load than an ordinary warehouse of a comparable size. Failure of a storage rack system in a retail environment is much more likely to cause personal injury than would a similar failure in a storage warehouse. To provide an appropriate level of additional safety in areas open to the public, an Importance Factor of 1.50 is specified. Storage rack contents, though beyond the scope of the standard, may pose a potentially serious threat to life

should they fall from the shelves in an earthquake. It is recommended that restraints be provided, as shown in Figure C15.5-1, to prevent the contents of rack shelving open to the general public from falling during strong ground shaking.



FIGURE C15.5-1 Merchandise restrained by netting

Source: FEMA 460 Seismic Considerations for Steel Storage Racks.

C15.5.3.2 Steel Cantilevered Storage Racks.

The two approaches to the design of steel cantilevered storage racks set forth by the standard are intended to produce comparable results. The specific development of a new RMI standard to include the detailed requirements of the new ANSI/RMI MH 16.3 (2016) specification, reflect the unique characteristics of this structural storage system, along with the recommendations of FEMA 460, *Seismic Considerations for Steel Storage Racks Located in Areas Accessible to the Public*.

The values of R , C_d , and Ω_0 added to Table 15.4-1 for Steel Cantilever Storage Racks were taken directly from Table 2.7.2.2.3 (1) of ANSI/RMI MH 16.3.

The anchorage provisions of the ANSI/RMI MH 16.3 specification are not in conformance with ASCE/SEI 7. Therefore, specific anchorage requirements were added in Section 15.5.3.2.1.

These recommendations address the concern that steel cantilevered storage racks in warehouse-type retail stores may pose a greater seismic risk to the general public than exists in low-occupancy warehouses or more conventional retail environments. Under normal conditions, retail stores have a far higher occupant load than an ordinary warehouse of a comparable size. Failure of a steel cantilevered storage rack system in a retail environment is much more likely to cause personal injury than would a similar failure in a storage warehouse. To provide an appropriate level of additional safety in areas open to the public, an Importance Factor of 1.50 is specified. Steel cantilevered storage rack contents, though beyond the scope of the standard, may pose a potentially serious threat to life should they fall from the shelves in an earthquake. It is recommended that restraints be provided, as shown in Figure C15.5-1, to prevent the contents of rack shelving open to the general public from falling during strong ground shaking.

All systems in ANSI/MH16.3, Table 2.7.2.2.3(1) are ordinary systems. For all systems in SDC B and C, the values in ANSI/MH16.3 (2016), Table 2.7.2.2.3(1) for R , Ω_0 , and C_d correspond to the values shown in Table 12.2-1 for Steel Systems Not Specifically Detailed for Seismic Resistance, Excluding Cantilever Column Systems. No seismic detailing is required. For hot-rolled steel systems in SDC D, E, and F, the

values in ANSI/MH16.3, Table 2.7.2.2.3(1) for R , Ω_0 , and C_d correspond to the values shown in Table 15.4-1 for ordinary systems with permitted height increase except that no height limits apply. The hot-rolled steel systems are detailed to AISC 341. For cold-formed steel systems in SDC D, E, and F, the values in ANSI/MH16.3 (2016), Table 2.7.2.2.3(1) for R , Ω_0 , and C_d correspond to the values shown in Table 15.4-1 for ordinary systems with unlimited height. Seismic detailing is not required for the cold-formed steel systems.

C15.5.4 Electrical Power-Generating Facilities.

Electrical power plants closely resemble building structures, and their performance in seismic events has been good. For reasons of mechanical performance, lateral drift of the structure must be limited. The lateral bracing system of choice has been the concentrically braced frame. In the past, the height limits on braced frames in particular have been an encumbrance to the design of large power-generating facilities. Based on acceptable past performance, Table 15.4-1 permits the use of ordinary concentrically braced frames with both lower R values and less restrictive height limits. This option is particularly effective for boiler buildings, which generally are 300 ft (91.4 m) or more high. A peculiarity of large boiler buildings is the general practice of suspending the boiler from the roof structures; this practice results in an unusual mass distribution, as discussed in Section C15.1.3.

C15.5.5 Structural Towers for Tanks and Vessels.

The requirements of this section apply to structural towers that are not integral with the supported tank. Elevated water tanks designed in accordance with AWWA D100 are not subject to Section 15.5.5. A structural tower supporting a tank or vessel is considered integral with the supported tank or vessel where the tank or vessel shell acts as a part of the seismic force-resisting system of the supporting tower.

Examples of structural towers that are not integral with the supported tank are shown in Figure C15.5-2. Examples of structural towers that are integral with the supported tank are shown in Figure C15.5-3. Examples of structural towers that are integral with the supported tank include column-supported elevated water tanks designed to AWWA D100 and column-supported liquid and gas spheres designed to ASME BVPC, Section VIII.



FIGURE C15.5-2 Examples of Structural Towers That are Not Integral with the Supported Tank

Source: (left) Courtesy of Chevron; reproduced with permission. (right) Courtesy of CB&I LLC; reproduced with permission.



FIGURE C15.5-3 Examples of Structural Towers That are Integral with the Supported Tank

Source: Courtesy of CB&I LLC; reproduced with permission.

C15.5.6 Piers and Wharves.

Current industry practice recognizes the distinct differences between the two categories of piers and wharves described in the standard. Piers and wharves with public occupancy, described in Section 15.5.6.2, are commonly treated as the “foundation” for buildings or buildinglike structures; design is performed using the standard, likely under the jurisdiction of the local building official. Piers and wharves without occupancy by the general public are often treated differently and are outside the scope of the standard; in many cases, these structures do not fall under the jurisdiction of building officials, and design is performed using other industry-accepted approaches.

Design decisions associated with these structures often reflect economic considerations by both owners and local, regional, or state jurisdictional entities with interest in commercial development. Where building officials have jurisdiction but lack experience analyzing pier and wharf structures, reliance on other industry-accepted design approaches is common.

Where occupancy by the general public is not a consideration, seismic design of structures at major ports and marine terminals often uses a performance-based approach, with criteria and methods that are very different from those used for buildings, as provided in the standard. Design approaches most commonly used are generally consistent with the practices and criteria described in the following documents: Seismic Design Guidelines for Port Structures (2001); Ferritto et al. (1999); Priestley et al. (1996); Werner (1998); Marine Oil Terminal Engineering and Maintenance Standards (2005).

These alternative approaches have been developed over a period of many years by working groups within the industry, and they reflect the historical experience and performance characteristics of these structures, which are very different from those of building structures.

The main emphasis of the performance-based design approach is to provide criteria and methods that depend on the economic importance of a facility. Adherence to the performance criteria in the documents listed does not seek to provide uniform margins of collapse for all structures; their application is expected to provide at least as much inherent life safety as for buildings designed using the standard. The reasons for the higher inherent level of life safety for these structures include the following:

1. These structures have relatively infrequent occupancy, with few working personnel and very low density of personnel. Most of these structures consist primarily of open area, with no enclosed structures that can collapse onto personnel. Small control buildings on marine oil terminals or similar secondary structures are commonly designed in accordance with the local building code.
2. These pier or wharf structures typically are constructed of reinforced concrete, prestressed concrete, or steel and are highly redundant because of the large number of piles supporting a single wharf deck unit. Tests done at the University of California at San Diego for the Port of Los

Angeles have shown that high ductilities (10 or more) can be achieved in the design of these structures using practices currently used in California ports.

3. Container cranes, loading arms, and other major structures or equipment on piers or wharves are specifically designed not to collapse in an earthquake. Typically, additional piles and structural members are incorporated into the wharf or pier specifically to support such items.
4. Experience has shown that seismic “failure” of wharf structures in zones of strong seismicity is indicated not by collapse but by economically irreparable deformations of the piles. The wharf deck generally remains level or slightly tilting but shifts out of position. Earthquake loading on properly maintained marine structures has never induced complete failure that could endanger life safety.
5. The performance-based criteria of the listed documents address reparability of the structure. These criteria are much more stringent than collapse prevention criteria and create a greater margin for life safety.

Lateral load design of these structures in low, or even moderate, seismic regions often is governed by other marine conditions.

C15.6 GENERAL REQUIREMENTS FOR NONBUILDING STRUCTURES NOT SIMILAR TO BUILDINGS

Nonbuilding structures not similar to buildings exhibit behavior markedly different from that of building structures. Most of these types of structures have reference documents that address their unique structural performance and behavior. The ground motion in the standard requires appropriate translation to allow use with industry standards.

C15.6.1 Earth-Retaining Structures.

Section C11.8.3 presents commonly used approaches for the design of nonyielding walls and yielding walls for bending, overturning, and sliding, taking into account the varying soil types, importance, and site seismicity.

C15.6.2 Chimneys and Stacks

C15.6.2.1 General.

The design of stacks and chimneys to resist natural hazards generally is governed by wind design considerations. The exceptions to this general rule involve locations with high seismicity, stacks and chimneys with large elevated masses, and stacks and chimneys with unusual geometries. It is prudent to evaluate the effect of seismic loads in all but those areas with the lowest seismicity. Although not specifically required, it is recommended that the special seismic details required elsewhere in the standard be considered for application to stacks and chimneys.

C15.6.2.2 Concrete Chimneys and Stacks.

Concrete chimneys typically possess low ductility, and their performance is especially critical in the regions around large (breach) openings because of reductions in strength and loss of confinement for vertical reinforcement in the jamb regions around the openings. Earthquake-induced chimney failures have occurred in recent history (in Turkey in 1999) and have been attributed to strength and detailing problems (Kilic and Sozen 2003). Therefore, the R value of 3 traditionally used in ASCE/SEI 7-05 for concrete stacks and chimneys was reduced to 2, and detailing requirements for breach openings were added in the 2010 edition of this standard.

C15.6.2.3 Steel Chimneys and Stacks.

Guyed steel stacks and chimneys generally are lightweight. As a result, the design loads caused by natural hazards generally are governed by wind. On occasion, large flares or other elevated masses located near the top may require in-depth seismic analysis. Although it does not specifically address seismic loading, Chapter 6 of Troitsky (1990) provides a methodology appropriate for resolution of the seismic forces defined in the standard in addition to the requirements found in ASME STS-1.

C15.6.4 Special Hydraulic Structures.

The most common special hydraulic structures are baffle walls and weirs that are used in water treatment and wastewater treatment plants. Because there are openings in the walls, during normal operations the fluid levels are equal on each side of the wall, exerting no net horizontal force. Sloshing during a seismic event can exert large forces on the wall, as illustrated in Figure C15.6-1. The walls can fail unless they are designed properly to resist the dynamic fluid forces.

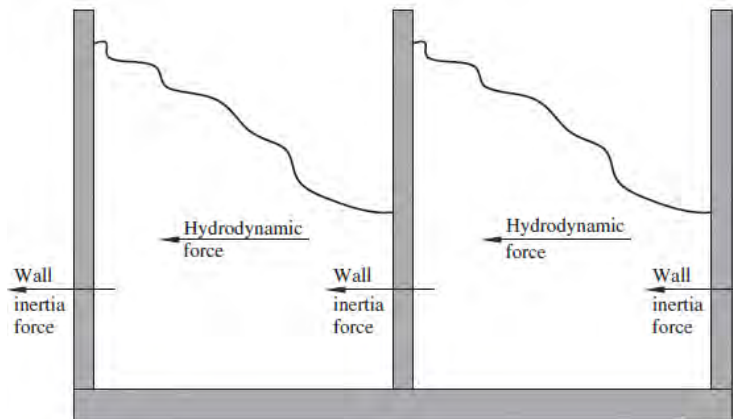

FIGURE C15.6-1 Wall forces

C15.6.5 Secondary Containment Systems.

This section reflects the judgment that designing all impoundment dikes for the MCE_R ground motion when full and sizing all impoundment dikes for the sloshing liquid height is too conservative. Designing an impoundment dike as full for the MCE_R assumes failure of the primary containment and occurrence of a significant aftershock. Such significant aftershocks (of the same magnitude as the MCE_R ground motion) are rare and do not occur in all locations. Although explicit design for aftershocks is not a requirement of the standard, secondary containment must be designed full for an aftershock to protect the general public. The use of two-thirds of the MCE_R ground motion as the magnitude of the design aftershock is supported by Bath's law, according to which the maximum expected aftershock magnitude may be estimated to be 1.2 scale units below the main shock magnitude.

The risk assessment and risk management plan described in Section 1.5.2 are used to determine where the secondary containment must be designed full for the MCE_R . The decision to design secondary containment for this more severe condition should be based on the likelihood of a significant aftershock occurring at the particular site, considering the risk posed to the general public by the release of hazardous material from the secondary containment.

Secondary containment systems must be designed to contain the sloshing liquid height where the release of liquid would place the general public at risk by exposing them to hazardous materials, by scouring of foundations of adjacent structures, or by causing other damage to adjacent structures.

C15.6.5.1 Freeboard.

Eq. (15.6-1) was revised in ASCE 7-10 to return to the more exact theoretical formulation for sloshing liquid height instead of the rounded value introduced in ASCE/SEI 7-05. The rounded value in part accounted for maximum direction of response effects. Because the ground motion definition in ASCE/SEI 7-10 was changed and the maximum direction of response is now directly accounted for, it is no longer necessary to account for these effects by rounding up the theoretical sloshing liquid height factor in Eq. (15.6-1).

C15.6.6 Telecommunication Towers.

Telecommunication towers support small masses, and their design generally is governed by wind forces. Although telecommunication towers have a history of experiencing seismic events without failure or significant damage, seismic design in accordance with the standard is required.

Typically bracing elements bolt directly (without gusset plates) to the tower legs, which consist of pipes or bent plates in a triangular plan configuration.

C15.6.7 Steel Tubular Support Structures for Onshore Wind Turbine Generator Systems.

The most common support structures for large onshore wind turbine generator systems are steel tubular towers. Recommendations for the design of these structures can be found in ASCE/AWEA (2011). ASCE/AWEA (2011) applies to wind turbines that have a rotor-swept area greater than 2,153 ft² (200 m²). These recommendations are to be used in conjunction with seismic lateral forces determined in accordance with Section 15.4. A typical steel tubular support structure for an onshore wind turbine generator system is shown in Figure C15.6-2.



FIGURE C15.6-2 Typical Steel Tubular Support Structure for Onshore Wind Turbine Generator Systems

Source: Courtesy of GE Power; reproduced with permission.

C15.6.8 Ground-Supported Cantilever Walls or Fences.

Ground-supported cantilever walls and fences constructed from masonry, concrete, timber, or a combination of materials, including steel, are common. Such walls are often used as sound barrier walls or to limit access to residential subdivisions. Ground-supported cantilever walls and fences include walls supported by a footing and pier and panel/pilaster and panel wall systems (Figure C15.6-3) as long as these systems are not supported laterally in the out-of-plane direction above grade. An example of a masonry ground-supported cantilever wall is shown in Figure C15.6-4. Many improperly designed ground-supported cantilever walls and fences constructed from masonry or concrete have experienced problems and have failed during seismic events as evidenced in Section 6.3.9.1 of FEMA E-74 (2012), *Reducing the Risks of Nonstructural Earthquake Damage—A Practical Guide*.

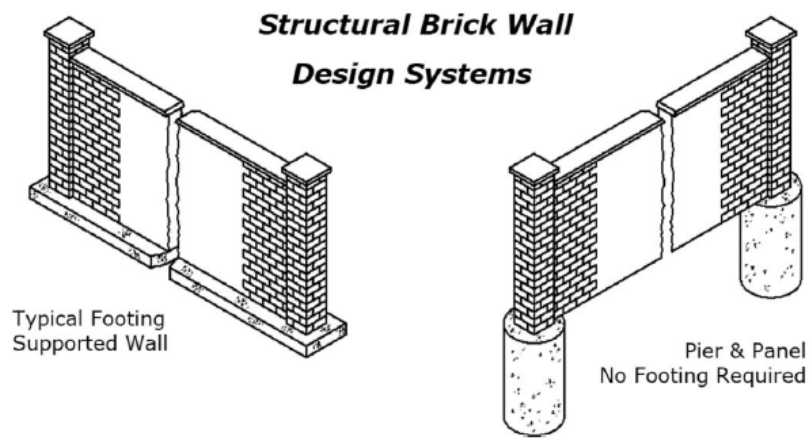

FIGURE C15.6-3 Typical Cantilever Wall Systems Falling under the Requirements of Section 15.6.8.

Source: Courtesy of J.G. Soules; reproduced with permission.



FIGURE C15.6-4 Typical Masonry Ground-Supported Cantilever Wall

The provisions for ground-supported cantilever walls and fences more than 6 ft (1.83 m) high were contained in prior issues of the Uniform Building Code, including the 1997 Uniform Building Code (ICBO 1997). When the International Building Code was developed, the provisions were inadvertently dropped and were not incorporated in ASCE 7. Walls of all heights should be properly designed. The 6-ft (1.83-m) height has been retained from the 1997 Uniform Building Code as the minimum height at which these provisions apply because walls less than 6 ft (1.83 m) high are not deemed to present as significant a risk to life safety.

The seismic design parameters chosen for this system are based on those given in Table 15.4-2 for “all other self-supporting structures, tanks, or vessels not covered above or by reference standards that are not similar to buildings” except that all height limits were changed to no limit (NL), considering that the structure is a cantilever wall. Cantilever walls covered by these provisions can be of any material or combination of materials; therefore, a relatively low value of R was chosen to account for these material combinations. Additionally, pilasters incorporated in many of these wall systems are essentially ordinary cantilever columns. Ordinary cantilever columns in ASCE 7 tend to have low R values irrespective of the material used.

A decision was made by the ASCE 7 Seismic Subcommittee that a ground-supported freestanding wall or fence was a nonbuilding structure not similar to a building and should fall under the provisions of Chapter 15 instead of Chapter 13.

C15.7 TANKS AND VESSELS

C15.7.1 General.

Methods for seismic design of tanks, currently adopted by a number of reference documents, have evolved from earlier analytical work by Jacobsen (1949), Housner (1963), Veletos (1974), Haroun and Housner (1981), and others. The procedures used to design flat-bottom storage tanks and liquid containers are based on the work of Housner (U.S. Department of Energy, 1963) and Wozniak and Mitchell (1978). The reference documents for tanks and vessels have specific requirements to safeguard against catastrophic failure of the primary structure based on observed behavior in seismic events since the 1930s. Other methods of analysis, using flexible shell models, have been proposed but at present are beyond the scope of the standard.

The industry-accepted design methods use three basic steps:

1. Dynamic modeling of the structure and its contents. When a liquid-filled tank is subjected to ground acceleration, the lower portion of the contained liquid, identified as the impulsive component of mass, W_i , acts as if it were a solid mass rigidly attached to the tank wall. As this mass accelerates, it exerts a horizontal force, P_i , on the wall; this force is directly proportional to the maximum acceleration of the tank base. This force is superimposed on the inertia force of the accelerating wall itself, P_s . Under the influence of the same ground acceleration, the upper portion of the contained liquid responds as if it were a solid mass flexibly attached to the tank wall. This portion, which oscillates at its own natural frequency, is identified as the convective component, W_c , and exerts a horizontal force, P_c , on the wall. The convective component oscillations are characterized by sloshing whereby the liquid surface rises above the static level on one side of the tank and drops below that level on the other side.
2. Determination of the period of vibration, T_i , of the tank structure and the impulsive component and determination of the natural period of oscillation (sloshing), T_c , of the convective component.
3. Selection of the design response spectrum. The response spectrum may be site specific, or it may be constructed on the basis of seismic coefficients given in national codes and standards. Once

the design response spectrum is constructed, the spectral accelerations corresponding to T_i and T_c are obtained and are used to calculate the dynamic forces P_i , P_s , and P_c .

Detailed guidelines for the seismic design of circular tanks, incorporating these concepts to varying degrees, have been the province of at least four industry reference documents: AWWA D100 for welded steel tanks (since 1964); API 650 for petroleum storage tanks; AWWA D110 for prestressed, wire-wrapped tanks (since 1986); and AWWA D115 for prestressed concrete tanks stressed with tendons (since 1995). In addition, API 650 and API 620 contain provisions for petroleum, petrochemical, and cryogenic storage tanks. The detail and rigor of analysis prescribed in these documents have evolved from a semistatic approach in the early editions to a more rigorous approach at present, reflecting the need to include the dynamic properties of these structures.

The requirements in Section 15.7 are intended to link the latest procedures for determining design-level seismic loads with the allowable stress design procedures based on the methods in the standard. These requirements, which in many cases identify specific substitutions to be made in the design equations of the reference documents, will assist users of the standard in making consistent interpretations.

ACI has published ACI 350.3-06 (2006), *Seismic Design of Liquid-Containing Concrete Structures*. This document, which addresses all types of concrete tanks (prestressed and nonprestressed, circular, and rectilinear), has provisions that are unfortunately not consistent with the seismic criteria of ASCE/SEI 7. However, the document, when combined with the modifications required in Section 15.7.7.3, serves as both a practical “how-to” loading reference and a guide to supplement application of ACI 318, Chapter 18.

C15.7.2 Design Basis.

In the case of the seismic design of nonbuilding structures, standardization requires adjustments to industry reference documents to minimize existing inconsistencies among them, while recognizing that structures designed and built over the years in accordance with these documents have performed well in earthquakes of varying severity. Of the inconsistencies among reference documents, the ones most important to seismic design relate to the base shear equation. The traditional base shear takes the following form:

$$V = \frac{ZIS}{R_w} CW \quad (\text{C15.7-1})$$

An examination of those terms as used in the different references reveals the following:

1. Z, S : The seismic zone coefficient, Z , has been rather consistent among all the documents because it usually has been obtained from the seismic zone designations and maps in the model building codes. However, the soil profile coefficient, S , does vary from one document to another. In some documents, these two terms are combined.
2. I : The Importance Factor, I , has varied from one document to another, but this variation is unavoidable and understandable because of the multitude of uses and degrees of importance of tanks and vessels.
3. C : The coefficient C represents the dynamic amplification factor that defines the shape of the design response spectrum for any given ground acceleration. Because C is primarily a function of the frequency of vibration, inconsistencies in its derivation from one document to another stem from at least two sources: differences in the equations for the determination of the natural frequency of vibration, and differences in the equation for the coefficient itself. (For example, for the shell/impulsive liquid component of lateral force, the steel tank documents use a constant design spectral acceleration [constant C] that is independent of the “impulsive” period, T .) In addition, the value of C varies depending on the damping ratio assumed for the vibrating structure (usually between 2% and 7% of critical).

4. Where a site-specific response spectrum is available, calculation of the coefficient C is not necessary except in the case of the convective component (coefficient C_c), which is assumed to oscillate with 0.5% of critical damping and whose period of oscillation is usually long (greater than 2.5 s). Because site-specific spectra are usually constructed for high damping values (3% to 7% of critical) and because the site-specific spectral profile may not be well-defined in the long-period range, an equation for C_c applicable to a 0.5% damping ratio is necessary to calculate the convective component of the seismic force.
5. R_w : The response modification factor, R_w , is perhaps the most difficult to quantify, for a number of reasons. Although R_w is a compound coefficient that is supposed to reflect the ductility, energy-dissipating capacity, and redundancy of the structure, it is also influenced by serviceability considerations, particularly in the case of liquid-containing structures.

In the standard, the base shear equation for most structures has been reduced to $V = C_s W$, where the seismic response coefficient, C_s , replaces the product ZSC / R_w . C_s is determined from the design spectral response acceleration parameters S_{DS} and S_{D1} (at short periods and at a period of 1, respectively), which in turn are obtained from the mapped MCE_R spectral accelerations S_s and S_1 . As in the case of the prevailing industry reference documents, where a site-specific response spectrum is available, C_s is replaced by the actual values of that spectrum.

The standard contains several bridging equations, each designed to allow proper application of the design criteria of a particular reference document in the context of the standard. These bridging equations associated with particular types of liquid-containing structures and the corresponding reference documents are discussed below. Calculation of the periods of vibration of the impulsive and convective components is in accordance with the reference documents, and the detailed resistance and allowable stresses for structural elements of each industry structure are unchanged, except where new information has led to additional requirements.

It is expected that the bridging equations of Section 15.7.7.3 will be eliminated as the relevant reference documents are updated to conform to the standard. The bridging equations previously provided for AWWA D100 and API 650 already have been eliminated as a result of updates of these documents.

Tanks and vessels are sensitive to vertical ground motions. Traditionally, the approach has been to apply a vertical seismic coefficient equal to $0.2S_{DS}$ to the design. This design approach came from the process used to design buildings and may underestimate the vertical response of the tank and its contents. For noncylindrical tanks, the increase in the hydrostatic pressure caused by vertical excitation has taken the form of $0.4S_{av}$, where S_{av} is determined in accordance with Section 15.7.2 and Section 11.9. This pressure is combined directly with the hydrodynamic loads induced from lateral ground motions. The result is equal to 100% horizontal plus 40% vertical. The response of cylindrical tanks to vertical motions is well known and documented in various papers. Unless otherwise specified in a reference document, the vertical period T_v , may be determined by

$$T_v = 2\pi \sqrt{\frac{\gamma_L R H_L^2}{g t E}} \quad (\text{C15.7-2})$$

where

γ_L = Unit weight of stored liquid;

R = Tank radius to the inside of the wall;

- H_L = liquid height inside the tank;
 g = acceleration caused by gravity in consistent units;
 t = average shell thickness; and
 E = modulus of elasticity of shell.

Eq. (C15.7-2) comes from ACI 350.3 (2006) and is based on a rigid response of the liquid to vertical ground motions. Additional documents, such as Section 7.7.1 of ASCE's *Guidelines for the Seismic Design of Oil and Gas Pipeline Systems* (1984) provide solutions to determine the response of a flexible tank to vertical ground motions. The response of the structure itself is set equal to 0.4 times the peak of the vertical response spectra. Using the peak of the vertical response spectra recognizes the vertical stiffness of the tank walls. This load is combined directly with loads produced from lateral ground motions. The result is equal to 100% horizontal plus 40% vertical. It should also be noted that R has been added to Eq. (15.7-1). R is included in the calculation of hoop stress because the response of the tank shell caused by the added hoop tension from vertical ground motions is no different than the response of the tank shell caused by the added hoop tension from horizontal ground motions. ACI 350.3 has used this philosophy for many years.

C15.7.3 Strength and Ductility.

As is the case for building structures, ductility and redundancy in the lateral support systems for tanks and vessels are desirable and necessary for good seismic performance. Tanks and vessels are not highly redundant structural systems, and therefore ductile materials and well-designed connection details are needed to increase the capacity of the vessel to absorb more energy without failure. The critical performance of many tanks and vessels is governed by shell stability requirements rather than by yielding of the structural elements. For example, contrary to building structures, ductile stretching of anchor bolts is a desirable energy absorption component where tanks and vessels are anchored. The performance of cross-braced towers is highly dependent on the ability of the horizontal compression struts and connection details to develop fully the tension yielding in the rods. In such cases, it is also important to preclude both premature failure in the threaded portion of the connection and failure of the connection of the rod to the column before yielding of the rod.

The changes made to Section 15.7.3(a) are intended to ensure that anchors and anchor attachments are designed such that the anchor yields (stretches) before the anchor attachment to the structure fails. The changes also clarify that the anchor rod embedment requirements are to be based on the requirements of Section 15.7.5 and not Section 15.7.3(a).

C15.7.4 Flexibility of Piping Attachments.

Poor performance of piping connections (tank leakage and damage) caused by seismic deformations is a primary weakness observed in seismic events. Although commonly used piping connections can impart mechanical loads to the tank shell, proper design in seismic areas results in only negligible mechanical loads on tank connections subject to the displacements shown in Table 15.7-1. API 650 treats the values shown in Table 15.7-1 as allowable stress-based values and therefore requires that these values be multiplied by 1.4 where strength-based capacity values are required for design.

The displacements shown in Table 15.7-1 are based on movements observed during past seismic events. The vertical tank movements listed are caused by stretch of the mechanical anchors or steel tendons (in the case of a concrete tank) for mechanically anchored tanks or the deflection caused by bending of the bottom of self-anchored tanks. The horizontal movements listed are caused by the deformation of the tank at the base.

In addition, interconnected equipment, walkways, and bridging between multiple tanks must be designed to resist the loads and accommodate the displacements imposed by seismic forces. Unless connected tanks and vessels are founded on a common rigid foundation, the calculated differential movements must be assumed to be out of phase.

C15.7.5 Anchorage.

Many steel tanks can be designed without anchors by using annular plate detailing in accordance with reference documents. Where tanks must be anchored because of overturning potential, proper anchorage design provides both a shell attachment and an embedment detail that allows the bolt to yield without tearing the shell or pulling the bolt out of the foundation. Properly designed anchored tanks have greater reserve strength to resist seismic overload than do unanchored tanks.

To ensure that the bolt yields (stretches) before failure of the anchor embedment, the anchor embedment must be designed in accordance with ACI 318, Eq. (17.4.1.2), and must be provided with a minimum gauge length of eight bolt diameters. Gauge length is the length of the bolt that is allowed to stretch. It may include part of the embedment length into the concrete that is not bonded to the bolt. A representation of gauge length is shown in Figure C15.7-1.

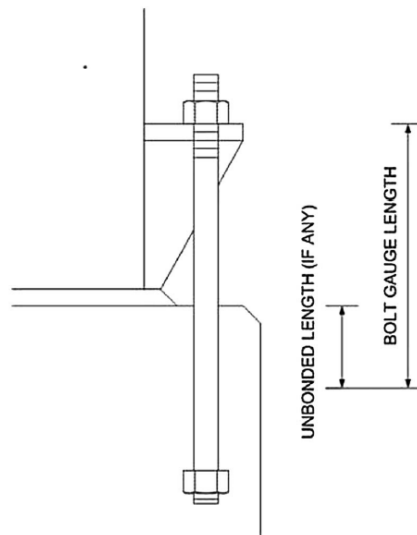

FIGURE C15.7-1 Bolt gauge length

It is also important that the bolt not be significantly oversized to ensure that the bolt stretches. The prohibition on using the load combinations with overstrength of Section 12.4.3 is intended to accomplish this goal.

Where anchor bolts and attachments are misaligned such that the anchor nut or washer does not bear evenly on the attachment, additional bending stresses in threaded areas may cause premature failure before anchor yielding.

C15.7.6 Ground-Supported Storage Tanks for Liquids

C15.7.6.1 General.

The response of ground storage tanks to earthquakes is well documented by Housner (1963), Wozniak and Mitchell (1978), Velesztos (1974), and others. Unlike building structures, the structural response of these tanks is influenced strongly by the fluid–structure interaction. Fluid–structure interaction forces are categorized as sloshing (convective) and rigid (impulsive) forces. The proportion of these forces depends on the geometry (height-to-diameter ratio) of the tank. API 650, API 620, AWWA D100-11, AWWA D110, AWWA D115, and ACI 350.3 provide the data necessary to determine the relative masses and moments for each of these contributions.

The standard requires that these structures be designed in accordance with the prevailing reference documents, except that the height of the sloshing wave, δ_s , must be calculated using Eq. (15.7-13). API 650 and AWWA D100-11 include this requirement in their latest editions.

Eqs. (15.7-10) and (15.7-11) provide the spectral acceleration of the sloshing liquid for the constant-velocity and constant-displacement regions of the response spectrum, respectively. The 1.5 factor in these equations is an adjustment for 0.5% damping. An exception in the use of Eq. (15.7-11) was added for the 2010 edition of this standard. The mapped values of T_L were judged to be unnecessarily conservative by the ASCE 7 Seismic Subcommittee in light of actual site-specific studies carried out since the introduction of the T_L requirements of ASCE/SEI 7-05. These studies indicate that the mapped values of T_L appear to be very conservative based on observations during recent large earthquakes, especially the 2010 M_w 8.8 Chilean earthquake, where the large amplifications at very long periods (6–10 s) were not evident either in the ground motion records or in the behavior of long-period structures (particularly sloshing in tanks). Because a revision of the T_L maps is a time-consuming task that was not possible during the 2010 update cycle, an exception was added to allow the use of site-specific values that are less than the mapped values with a floor of 4 s or one-half the mapped value of T_L . The exception was added under Section 15.7.6 because, for nonbuilding structures, the overly conservative values for T_L are primarily an issue for tanks and vessels. Discussion of the site-specific procedures can be found in the Commentary for Chapter 22.

Small-diameter tanks and vessels are more susceptible to overturning and vertical buckling. As a general rule, a greater ratio of H/D produces lower resistance to vertical buckling. Where H/D is greater than 2, overturning approaches “rigid mass” behavior (the sloshing mass is small). Large-diameter tanks may be governed by additional hydrodynamic hoop stresses in the middle regions of the shell.

The impulsive period (the natural period of the tank components and the impulsive component of the liquid) is typically in the 0.25–0.6 s range. Many methods are available for calculating the impulsive period. The Veletsos flexible-shell method is commonly used by many tank designers. For example, see Veletsos (1974) and Malhotra et al. (2000).

C15.7.6.1.1 Distribution of Hydrodynamic and Inertia Forces.

Most of the reference documents for tanks define reaction loads at the base of the shell–foundation interface, without indicating the distribution of loads on the shell as a function of height. ACI 350.3 specifies the vertical and horizontal distribution of such loads.

The overturning moment at the base of the shell in the industry reference documents is only the portion of the moment that is transferred to the shell. The total overturning moment also includes the variation in bottom pressure, which is an important consideration for design of pile caps, slabs, or other support elements that must resist the total overturning moment. Wozniak and Mitchell (1978) and U.S. Department of Energy TID-7024 (1963) provide additional information.

C15.7.6.1.2 Sloshing.

In past earthquakes, sloshing contents in ground storage tanks have caused both leakage and noncatastrophic damage to the roof and internal components. Even this limited damage and the associated costs and inconvenience can be significantly mitigated where the following items are considered:

1. Effective masses and hydrodynamic forces in the container;
2. Impulsive and pressure loads at
 - a. The sloshing zone (that is, the upper shell and edge of the roof system);
 - b. The internal supports (such as roof support columns and tray supports); and
 - c. The internal equipment (such as distribution rings, access tubes, pump wells, and risers);
 and
3. Freeboard (which depends on the sloshing wave height).

When no freeboard is required, a minimum freeboard of $0.7\delta_s$ is recommended for economic considerations. Freeboard is always required for tanks assigned to Risk Category IV.

Tanks and vessels storing biologically or environmentally benign materials typically do not require freeboard to protect the public health and safety. However, providing freeboard in areas of frequent seismic occurrence for vessels normally operated at or near top capacity may lessen damage (and the cost of subsequent repairs) to the roof and upper container. The exception to the minimum required freeboard per Table 15.7-3 for open-top tanks was added because it is rare for damage to occur that would impair the functionality of the facility when water or municipal wastewater overtops an open-top tank, provided that measures have been taken to intercept and properly handle the resulting overflow.

The sloshing liquid height specified in Section 15.7.6.1.2 is based on the design earthquake defined in the standard. For economic reasons, freeboard for tanks assigned to Risk Category I, II, or III may be calculated using a fixed value of T_L equal to 4 s (as indicated in Section 15.7.6.1.2, c) but using the appropriate Importance Factor taken from Table 1.5-2. Because of life-safety and operational functionality concerns, freeboard for tanks assigned to Risk Category IV must be based on the mapped value of T_L . Because use of the mapped value of T_L results in the theoretical maximum value of freeboard, the calculation of freeboard in the case of Risk Category IV tanks is based on an Importance Factor equal to 1.0 (as indicated in Section 15.7.6.1.2 b).

If the freeboard provided is less than the computed sloshing height, δ_s , the sloshing liquid impinges on the roof in the vicinity of the roof-to-wall joint, subjecting it to a hydrodynamic force. This force may be approximated by considering the sloshing wave as a hypothetical static liquid column that has a height, δ_s . The pressure exerted at any point along the roof at a distance y_s above the at-rest surface of the stored liquid may be assumed to be equal to the hydrostatic pressure exerted by the hypothetical liquid column at a distance $\delta_s - y_s$ from the top of that column. A better approximation of the pressure exerted on the roof is found in Malhotra (2005, 2006).

Another effect of a less-than-full freeboard is that the restricted convective (sloshing) mass “converts” into an impulsive mass, thus increasing the impulsive forces. This effect should be taken into account in the tank design. A method for converting the restricted convective mass into an impulsive mass is found in Malhotra (2005, 2006). It is recommended that sufficient freeboard to accommodate the full sloshing height be provided wherever possible.

Eq. (15.7-13) was revised to use the theoretical formulation for sloshing wave height instead of the rounded value introduced in ASCE/SEI 7-05. The rounded value of Eq. (15.6-1) increased the required freeboard by approximately 19%, thereby significantly increasing the cost of both secondary containment and large-diameter, ground-supported storage tanks. See Section C15.6.5.1 for additional commentary on freeboard.

C15.7.6.1.4 Internal Elements.

Wozniak and Mitchell (1978) provide a recognized analysis method for determining the lateral loads on internal components caused by sloshing liquid.

C15.7.6.1.5 Sliding Resistance.

Historically, steel ground-supported tanks full of product have not slid off foundations. A few unanchored, empty tanks or bulk storage tanks without steel bottoms have moved laterally during earthquake ground shaking. In most cases, these tanks may be returned to their proper locations. Resistance to sliding is obtained from the frictional resistance between the steel bottom and the sand cushion on which bottoms are placed. Because tank bottoms usually are crowned upward toward the tank center and are constructed of overlapping, fillet-welded, individual steel plates (resulting in a rough bottom), it is reasonably conservative to take the ultimate coefficient of friction on concrete as 0.70 (AISC 1986), and therefore a value of $\tan 30^\circ$

(= 0.577) for sand is used in design. The value of 30° represents the internal angle of friction of sand and is conservatively used in design. The vertical weight of the tank and contents, as reduced by the component of vertical acceleration, provides the net vertical load. An orthogonal combination of vertical and horizontal seismic forces, following the procedure in Section 12.5.3, may be used. In recent years, a significant issue has been the prevention of subsurface pollution caused by tank bottom corrosion and leakage. To prevent this problem, liners are often used with the tank foundation. When some of these liners are used, sliding of the tank and/or foundation caused by the seismic base shear may be an issue. If the liner is completely contained within a concrete ring-wall foundation, the liner's surface is not the critical plane to check for sliding. If the liner is placed within an earthen foundation or is placed above or completely below a concrete foundation, it is imperative that sliding be evaluated. It is recommended that the sliding resistance factor of safety be at least 1.5.

C15.7.6.1.6 Local Shear Transfer.

The transfer of seismic shear from the roof to the shell and from the shell to the base is accomplished by a combination of membrane shear and radial shear in the wall of the tank. For steel tanks, the radial (out-of-plane) seismic shear is very small and usually is neglected; thus, the shear is assumed to be resisted totally by membrane (in-plane) shear. For concrete walls and shells, which have a greater radial shear stiffness, the shear transfer may be shared. The ACI 350.3-06 (2006) commentary provides further discussion.

C15.7.6.1.7 Pressure Stability.

Internal pressure may increase the critical buckling capacity of a shell. Provision to include pressure stability in determining the buckling resistance of the shell for overturning loads is included in AWWA D100-11 (2011). Recent testing on conical and cylindrical shells with internal pressure yielded a design methodology for resisting permanent loads in addition to temporary wind and seismic loads (Miller et al. 1997).

C15.7.6.1.8 Shell Support.

Anchored steel tanks should be shimmed and grouted to provide proper support for the shell and to reduce impact on the anchor bolts under reversible loads. The high bearing pressures on the toe of the tank shell may cause inelastic deformations in compressible material (such as fiberboard), creating a gap between the anchor and the attachment. As the load reverses, the bolt is no longer snug and an impact of the attachment on the anchor can occur. Grout is a structural element and should be installed and inspected as an important part of the vertical and lateral force-resisting system.

C15.7.6.1.9 Repair, Alteration, or Reconstruction.

During their service life, storage tanks are frequently repaired, modified, or relocated. Repairs often are related to corrosion, improper operation, or overload from wind or seismic events. Modifications are made for changes in service, updates to safety equipment for changing regulations, or installation of additional process piping connections. It is imperative that these repairs and modifications be designed and implemented properly to maintain the structural integrity of the tank or vessel for seismic loads and the design operating loads.

The petroleum steel tank industry has developed specific guidelines in API 653 that are statutory requirements in some states. It is recommended that the provisions of API 653 also be applied to other liquid storage tanks (e.g., water, wastewater, and chemical) as it relates to repairs, modifications, or relocation that affect the pressure boundary or lateral force-resisting system of the tank or vessel.

C15.7.7 Water Storage and Water Treatment Tanks and Vessels.

The AWWA design requirements for ground-supported steel water storage structures use allowable stress design procedures that conform to the requirements of the standard.

C15.7.7.1 Welded Steel.

AWWA D100 refers to ASCE 7-05 and repeats the ASCE 7-05 seismic design ground motion maps within the body of the document. A requirement is added in this section to point the user to the ground motions in the current version of ASCE 7. The clause in AWWA D100, Section 13.5.4.4, “unless otherwise specified” in the context of the determination of seismic freeboard can result in seismic freeboard below that required by ASCE 7 and is therefore disallowed.

C15.7.7.2 Bolted Steel.

A clarification on the ground motions to use in design is added and restrictions are added on the use of Type 6 tanks in AWWA D103 (2009). AWWA D103 refers to ASCE 7-05 and repeats the ASCE 7-05 ground motion maps within the body of the document. Therefore, a clarifying statement is added to point the user to the seismic design ground motions in the current version of ASCE 7. A Type 6 tank is a concrete-bottom bolted steel shell tank with an embedded steel base setting ring. Type 6 tanks are considered to be mechanically anchored. There are no requirements for the anchorage design or bottom design (other than ACI 318) in AWWA D103. For the tank to be considered mechanically anchored, the tank bottom cannot uplift. In this case, the tank bottom is the foundation. If the bottom/foundation uplifts, the tank is now a self-anchored tank and the additional shell compression that develops must be taken into account in the design. That is why J in equation 14–32 of AWWA D103 (2009) is limited to 0.785.

C15.7.7.3 Reinforced and Prestressed Concrete.

A review of ACI 350.3 (2006), *Seismic Design of Liquid-Containing Concrete Structures and Commentary*, revealed that this document is not in general agreement with the seismic provisions of ASCE/SEI 7-10.

This section was clarified to note that the Importance Factor, I , and the response modification factor, R , are to be specified by ASCE/SEI 7 and not the reference document. The descriptions used in ACI 350.3 to determine the applicable values of the Importance Factor and response modification factor do not match those used in ASCE/SEI 7.

It was noted that the ground motions for determining the convective (sloshing) seismic forces specified in ACI 350.3 were not the same and are actually lower than those specified by ASCE/SEI 7. ACI 350.3 essentially redefines the long-period transition period, T_L . This alternate transition period allows large-diameter tanks to have significantly lower convective forces and lower seismic freeboard than those permitted by the provisions of ASCE/SEI 7. Therefore, Section 15.7.7.3 was revised to require that the convective acceleration be determined according to the procedure found in Section 15.7.6.1.

C15.7.8 Petrochemical and Industrial Tanks and Vessels Storing Liquids**C15.7.8.1 Welded Steel.**

The American Petroleum Institute (API) uses an allowable stress design procedure that conforms to the requirements of the standard.

The most common damage to tanks observed during past earthquakes includes the following:

1. Buckling of the tank shell near the base because of excessive axial membrane forces. This buckling damage is usually evident as “elephant foot” buckles a short distance above the base or as diamond-shaped buckles in the lower ring. Buckling of the upper ring also has been observed.
2. Damage to the roof caused by impingement on the underside of the roof of sloshing liquid with insufficient freeboard.
3. Failure of piping or other attachments that are overly restrained.
4. Foundation failures.

Other than the above damage, the seismic performance of floating roofs during earthquakes has generally been good, with damage usually confined to the rim seals, gauge poles, and ladders. However, floating roofs have sunk in some earthquakes because of lack of adequate freeboard or the proper buoyancy and strength required by API 650. Similarly, the performance of open-top tanks with top wind girder stiffeners designed per API 650 has been generally good.

C15.7.8.2 Bolted Steel.

Bolted steel tanks are often used for temporary functions. Where use is temporary, it may be acceptable to the jurisdictional authority to design bolted steel tanks for no seismic loads or for reduced seismic loads based on a reduced return period. For such reduced loads based on reduced exposure time, the owner should include a signed removal contract with the fixed removal date as part of the submittal to the authority having jurisdiction.

C15.7.9 Ground-Supported Storage Tanks for Granular Materials

C15.7.9.1 General.

The response of a ground-supported storage tank storing granular materials to a seismic event is highly dependent on its height-to-diameter (H/D) ratio and the characteristics of the stored product. The effects of intergranular friction are described in more detail in Section C15.7.9.3.1 (increased lateral pressure), C15.7.9.3.2 (effective mass), and C15.7.9.3.3 (effective density).

Long-term increases in shell hoop tension because of temperature changes after the product has been compacted also must be included in the analysis of the shell; Anderson (1966) provides a suitable method.

C15.7.9.2 Lateral Force Determination.

Seismic forces acting on ground-supported liquid storage tanks are divided between impulsive and convective (sloshing) components. However, in a ground-supported storage tank for granular materials, all seismic forces are of the impulsive type and relate to the period of the storage tank itself. Because of the relatively short period of a tank shell, the response is normally in the constant acceleration region of the response spectrum, which relates to S_{DS} . Therefore, the seismic base shear is calculated as follows:

$$V = \frac{S_{DS}}{\left(\frac{R}{I}\right)} W_{\text{effective}} \quad (\text{C15.7-3})$$

where V , S_{DS} , I , and R have been previously defined, and $W_{\text{effective}}$ is the gross weight of the stored product multiplied by an effective mass factor and an effective density factor, as described in Sections C15.7.9.3.2 and C15.7.9.3.3, plus the dead weight of the tank. Unless substantiated by testing, it is recommended that the product of the effective mass factor and the effective density factor be taken as no less than 0.5 because of the limited test data and the highly variable properties of the stored product.

C15.7.9.3 Force Distribution to Shell and Foundation

C15.7.9.3.1 Increased Lateral Pressure.

In a ground-supported tank storing granular materials, increased lateral pressures develop as a result of rigid body forces that are proportional to ground acceleration. Information concerning design for such pressure is scarce. Trahair et al. (1983) describe both a simple, conservative method and a difficult, analytical method using failure wedges based on the Mononobe–Okabe modifications of the classical Coulomb method.

C15.7.9.3.2 Effective Mass.

For ground-supported tanks storing granular materials, much of the lateral seismic load can be transferred directly into the foundation, via intergranular shear, before it can reach the tank shell. The effective mass that loads the tank shell is highly dependent on the H/D ratio of the tank and the characteristics of the stored product. Quantitative information concerning this effect is scarce, but Trahair et al. (1983) describe a simple, conservative method to determine the effective mass. That method presents reductions in effective mass, which may be significant, for H/D ratios less than 2. This effect is absent for elevated tanks.

C15.7.9.3.3 Effective Density.

Granular material stored in tanks (both ground-supported and elevated) does not behave as a solid mass. Energy loss through intergranular movement and grain-to-grain friction in the stored material effectively reduces the mass subject to horizontal acceleration. This effect may be quantified by an effective density factor less than 1.0.

Based on Chandrasekaran and Jain (1968) and on shake table tests reported in Chandrasekaran et al. (1968), ACI 313 (1997) recommends an effective density factor of not less than 0.8 for most granular materials. According to Chandrasekaran and Jain (1968), an effective density factor of 0.9 is more appropriate for materials with high moduli of elasticity, such as aggregates and metal ores.

C15.7.9.3.4 Lateral Sliding.

Most ground-supported steel storage tanks for granular materials rest on a base ring and do not have a steel bottom. To resist seismic base shear, a partial bottom or annular plate is used in combination with anchor bolts or a curb angle. An annular plate can be used alone to resist the seismic base shear through friction between the plate and the foundation, in which case the friction limits of Section 15.7.6.1.5 apply. The curb angle detail serves to keep the base of the shell round while allowing it to move and flex under seismic load. Various base details are shown in Figure 13 of Kaups and Lieb (1985).

C15.7.9.3.5 Combined Anchorage Systems.

This section is intended to apply to combined anchorage systems that share loads based on their relative stiffnesses, and not to systems where sliding is resisted completely by one system (such as a steel annular plate) and overturning is resisted completely by another system (such as anchor bolts).

C15.7.10 Elevated Tanks and Vessels for Liquids and Granular Materials**C15.7.10.1 General.**

The three basic lateral load-resisting systems for elevated water tanks are defined by their support structure:

1. Multilegged braced steel tanks (trussed towers, as shown in Figure C15.1-1);
2. Small-diameter, single-pedestal steel tank (cantilever column, as shown in Figure C15.7-2); and
3. Large-diameter, single-pedestal tanks of steel or concrete construction (load-bearing shear walls, as shown in Figure C15.7-3).



FIGURE C15.7-2 Small-diameter, single-pedestal steel tank

Source: Courtesy of CB&I LLC; reproduced with permission.

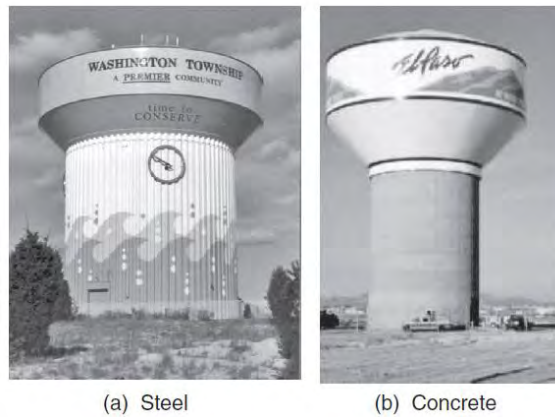

(a) Steel

(b) Concrete

FIGURE C15.7-3 Large-diameter, single-pedestal tank
Source: Courtesy of CB&I LLC; reproduced with permission.

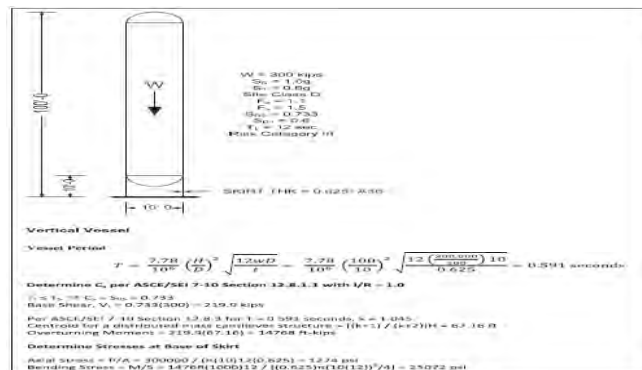

FIGURE C15.7-4 Example Problem Using ASME BPVC (2007), Section VIII, Division 2, 2008 Addenda, Paragraph 4.4

Input Data for ASME Section VIII, Div. 2 Buckling Checks (Paragraph 4.4)		
Input Values		
Course =	Skirt	
t = thickness of vessel section =	0.625	in.
H _T = top elevation of course =	120	in.
H _B = bottom elevation of course =	0	in.
D _O = outer diameter of vessel section =	120	in.
E _y = material modulus of elasticity =	29,000,000	psi
S _y = material yield strength =	36,000	psi
P _{ext} = external pressure =	0.000	psi
f _a = axial comp membrane stress from axial load =	1,274	psi
f _b = axial comp membrane stress from bending =	25,072	psi
V = net section shear force =	219,900	lbs
V _{phi} = applied shear force angle =	90	deg.
C _m = coefficient =	1	0.85, 1, or 0.6 – 0.4(M ₁ /M ₂)
K _u = effective length factor =	2.1	Free-Fixed
L _u = maximum unbraced length =	1,200	in.
L = design length vessel section for external pressure =	120	in.
L = design length vessel section for axial compression =	120	in.
FS = Input Factor of Safety =	1.0	
Calculated Values		
R _o = outer radius of shell section =	60	in.
R = radius to center of shell =	59.6875	in.
R _m = vessel mean radius =	59.6875	in.
r = radius of gyration of cyl = (1/4)(D _o ² + D _i ²) ^{0.5} =	42.2	in.
A = Cross sectional area of cylinder =	234.4	in ²
f _o = axial compressive membrane stress = P _{ext} πD _i ² /4A =	0.0	psi
4.4.12 Combined Loadings and Allowable Compressive Stresses (continued)		
b) Axial Compressive Stress Acting Alone - The allowable axial compressive membrane stress of a cylinder subject to an axial compressive load acting alone, F _{xa} , is computed by following equations.		
1) For lambda_c ≤ 0.15 (Local Buckling)		
F _{xa} = min [F _{xa1} , F _{xa2}]		(4.4.61)
F _{xa1} = S _y / FS	for D _o /t ≤ 135	(4.4.62)
F _{xa1} = 466 S _y / [(331 + D _o /t) FS]	for 135 < D _o /t < 600	(4.4.63)
F _{xa1} = 0.5 S _y / FS	for 135 < D _o /t < 600	(4.4.64)
F _{xa2} = F _{xe} / FS		(4.4.65)
where: F _{xe} = C _x E _y t/D _o		(4.4.66)
C _x = min[409 c / [389 + D _o /t], 0.9]	for D _o /t < 1247	(4.4.67)
C _x = 0.25 c	for 1247 ≤ D _o /t ≤ 2000	(4.4.68)
c = 2.64	for M _x ≤ 1.5	(4.4.69)
c = 3.13 / M _x ^{0.42}	for 1.5 < M _x < 15	(4.4.70)
c = 1.0	for M _x ≥ 15	(4.4.71)

FIGURE C15.7-4 (Continued) Example Problem Using ASME BPVC (2007), Section VIII, Division 2, 2008 Addenda, Paragraph 4.4

4.4.12 Combined Loadings and Allowable Compressive Stresses (continued)

$$M_x = L/(R_0 t)^{1/2} \quad (4.4.124)$$

where L is the design length of a vessel section between lines of support

$$D_o/t = 192.00 \quad 135 < D_o/t < 600$$

$$M_x = L/(R_0 t)^{1/2} = 19.60 > 15 \quad c = 1.0000$$

$$D_o/t < 1247 \quad C_x = \min [409 c / [389 + D_o/t], 0.9] = 0.7039587 \quad (4.4.67)$$

$$F_{xe} = C_x E_y t / D_o = 106,327 \text{ psi} \quad (4.4.66)$$

Calculate F_{xa1} Calculate F_{xa2}

$$F_{ic} = 466 S_y / [(331 + D_o/t)] = 32,076 \text{ psi} \quad F_{ic} = 106,327 \text{ psi}$$

Use Input FS = 1.0 Use Input FS = 1.0

$$F_{xa1} = 466 S_y / [(331 + D_o/t)FS] = 32,076 \text{ psi} \quad F_{xa2} = F_{xe}/FS = 106,327 \text{ psi} \quad (4.4.65)$$

Calculate F_{xa}

$$F_{xa} = \min [F_{xa1}, F_{xa2}] = 32,076 \text{ psi} \quad (4.4.61)$$

$$\lambda_{dc} = (K) (L_u) / [(\pi)(r_g)] [(F_{xa}) (FS) / E]^{0.5} = 0.6321 \quad 0.15 < \lambda_{dc} < 1.147$$

2) For $\lambda_{dc} > 0.15$ and $K L_u / r_g < 200$ (Column Buckling)

$$F_{ca} = F_{xa} (1 - 0.74 (\lambda_{dc} - 0.15))^{0.3} \quad 0.15 < \lambda_{dc} < 1.147 \quad (4.4.72)$$

$$F_{ca} = 0.88 F_{xa} / (\lambda_{dc})^2 \quad \lambda_{dc} \geq 1.147 \quad (4.4.73)$$

$K L_u / r_g = 59.7 < 200$

$\lambda_{dc} > 0.15$ and $K L_u / r_g < 200$ therefore:

$$F_{ca} = F_{xa} (1 - 0.74 (\lambda_{dc} - 0.15))^{0.3} = 28,100 \text{ psi}$$

c) Compressive Bending Stress - The allowable axial compressive membrane stress of a cylindrical shell subject to a bending moment acting across the full circular cross section F_{ba} , is computed using the following equations.

$$F_{ba} = F_{xa} \quad \text{for } 135 \leq D_o / t \leq 2000 \quad (4.4.74)$$

$$F_{ba} = 466 S_y / [(331 + D_o / t) FS] \quad \text{for } 100 < D_o / t < 135 \quad (4.4.75)$$

$$F_{ba} = 1.081 S_y / FS \quad \text{for } D_o / t < 100 \text{ and } \gamma > 0.11 \quad (4.4.76)$$

$$F_{ba} = (1.4 - 2.9 \gamma) S_y / FS \quad \text{for } D_o / t < 100 \text{ and } \gamma < 0.11 \quad (4.4.77)$$

where: $\gamma = S_y D_o / E_y t$ (4.4.78)

$$D_o / t = 192$$

$$\gamma = S_y D_o / E_y t = 0.2383 \quad F_{ic} = F_{xa}$$

$$F_{ic} = 32,076 \text{ psi}$$

$$D_o / t = 192 > 135 \text{ (see Sect. 3.1.1)} \quad \text{Use Input FS} = 1.0$$

$$F_{ba} = F_{xa} = 32,076 \text{ psi}$$

FIGURE C15.7-4 (Continued) Example Problem Using ASME BPVC (2007), Section VIII, Division 2, 2008 Addenda, Paragraph 4.4

d) Shear Stress - The allowable shear stress of a cylindrical shell, F_{va} , is computed using the following equations.

$$F_{va} = n_v F_{ve} / FS \quad (4.4.79)$$

$$\text{where: } F_{ve} = a_v C_v E t / D_o \quad (4.4.80)$$

$$C_v = 4.454 \quad \text{for } M_x < 1.5 \quad (4.4.81)$$

$$C_v = (9.64 / M_x^2) (1 + 0.0239 M_x^3)^{1/2} \quad \text{for } 1.5 < M_x < 26 \quad (4.4.82)$$

$$C_v = 1.492 / (M_x)^{1/2} \quad \text{for } 26 < M_x < 4.347 D_o / t \quad (4.4.83)$$

$$C_v = 0.716 (t / D_o)^{1/2} \quad \text{for } M_x > 4.347 D_o / t \quad (4.4.84)$$

$$a_v = 0.8 \quad \text{for } D_o / t < 500 \quad (4.4.85)$$

$$a_v = 1.389 - 0.218 \log_{10} (D_o / t) \quad \text{for } D_o / t > 500 \quad (4.4.86)$$

$$n_v = 1.0 \quad \text{for } F_{ve} / S_y < 0.48 \quad (4.4.87)$$

$$n_v = 0.43 S_y / F_{ve} + 0.1 \quad \text{for } 0.48 < F_{ve} / S_y < 1.7 \quad (4.4.88)$$

$$n_v = 0.6 S_y / F_{ve} \quad \text{for } F_{ve} / S_y > 1.7 \quad (4.4.89)$$

$$D_o / t = 192$$

$$M_x = L / (R_o t)^{0.5} = 19.596$$

$$1.5 < M_x < 26 \quad C_v = (9.64 / M_x^2) (1 + 0.0239 M_x^3)^{0.5} = 0.3376$$

$$D_o / t < 500 \quad a_v = 0.8000$$

$$F_{ve} = a_v C_v E t / D_o = 40,793 \text{ psi}$$

$$F_{ve} / S_y = 1.13 \quad 0.48 < F_{ve} / S_y < 1.7$$

$$n_v = 0.43 S_y / F_{ve} + 0.1 = 0.4795$$

$$F_{ic} = 19,559 \text{ psi}$$

$$\text{Use Input FS} = 1.000$$

$$F_{va} = n_v F_{ve} / FS = 19,559 \text{ psi}$$

4.4.12 Combined Loadings and Allowable Compressive Stresses (continued)

Axial Compressive Stress, Compressive Bending Stress, and Shear - the allowable compressive stress for the combination of uniform axial compression, axial compression due to bending, and shear in the absence of hoop compression.

$$\text{Let } K_s = 1 - (f_v / F_{va})^2 \quad (4.4.105)$$

For $0.15 < \lambda_{dc} < 1.2$

$$\lambda_{dc} = 0.63 \quad (\text{Section 3.2}) \quad 0.15 < \lambda_{dc} < 1.2 \quad \text{OK}$$

$$f_a / (K_s F_{ca}) + (8 / 9) (\delta) f_b / (K_s F_{ba}) < 1.0 \quad f_a / (K_s F_{ca}) > 0.2 \quad (4.4.112)$$

$$f_a / (2 K_s F_{ca}) + (\delta) f_b / (K_s F_{ba}) < 1.0 \quad f_a / (K_s F_{ca}) < 0.2 \quad (4.4.113)$$

$$K_s = 1 - (f_v / F_{va})^2 = 0.9977$$

$$F_c = (\pi)^2 E / [K_s L_u / r]^2 = 80,287 \text{ psi}$$

$$\delta = C_m / [1 - f_a FS / F_c] = 1.0161$$

$$f_a / (K_s F_{ca}) = 0.045442959 < 0.2$$

$$f_a / (2 K_s F_{ca}) + (\delta) f_b / (K_s F_{ba}) = 0.82 < 1.0 \quad \text{OK!}$$

FIGURE C15.7-4 (Continued) Example Problem Using ASME BPVC (2007), Section VIII, Division 2, 2008 Addenda, Paragraph 4.4

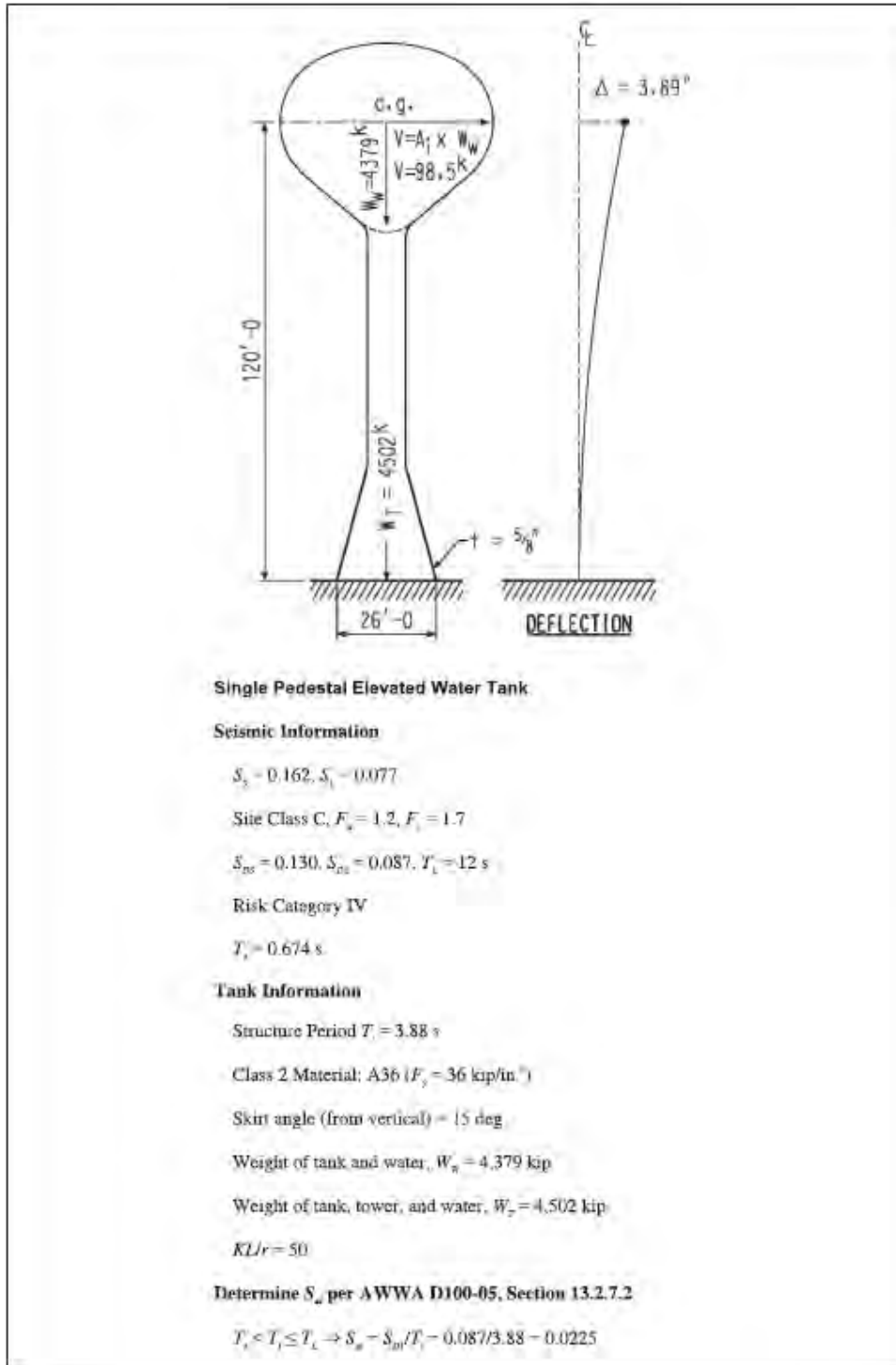

FIGURE C15.7-5 Example Problem Using AWWA D100-05, Section 13.4.3.4

Determine Critical Buckling Acceleration ($I/1.4 R_c = 1$)

Per Section 13.4.3.4, $A_1 = S_w$ for critical buckling check (A_1 in AWWA D100-05 is the same as C_s in ASCE/SEI 7-10)

$$A_1 = 0.0225$$

Lateral Displacement Caused by S_w ($P-\Delta$)

The final deflected position of the water centroid is an iterative process and must account for the additional moment applied to the structure because of the $P-\Delta$ effect. The deflection from the critical buckling deflection is equal to 3.89 in.

Check Skirt at Base of Tower

Seismic overturning moment at base of tower without $P-\Delta = 11,928$ ft-kip (includes mass of tower).

Seismic overturning moment at base of tower with $P-\Delta = 11,928$ ft-kip + $4,379$ kip \times 3.89 in./ 12 in. per ft

$$= 13,348 \text{ ft-kip}$$

Area of skirt = $\pi(26 \times 12)(0.625) = 612.6 \text{ in.}^2$

Section modulus of skirt = $\pi(26 \times 12)^2/4 \times 0.625 = 47,784 \text{ in.}^3$

Skirt stress caused by axial load = $4,502(1,000)/(612.6 \times \cos 15) = 7,608 \text{ lb/in.}^2$

Skirt stress caused by moment = $13,348(12)(1000)/(47,784 \times \cos 15) = 3,470 \text{ lb/in.}^2$

Determine Critical Buckling Stress

$$R = 13 \times 12/\cos 15 = 161.5 \text{ in.}$$

$$t/R = 0.625/161.5 = 0.0039$$

For Class 2 material, $KL/r = 50$, and $t/R = 0.0039$, determine allowable axial compressive stress, F_a , from Table 13 of AWWA D100-05.

$$F_a = 9,882 \text{ lb/in.}^2$$

Per AWWA D100-05, Section 13.4.3.4,

Critical buckling stress = $2F_a = 19,764 \text{ lb/in.}^2$

For Class 2 material and $t/R = 0.0039$, determine allowable bending compressive stress, F_b , from Table 11 of AWWA D100-05.

$$F_b = F_t = 10,380 \text{ lb/in.}^2$$

Per AWWA D100-05, Section 13.4.3.4,

Critical bending stress = $2F_b = 20,760 \text{ lb/in.}^2$

Check unity per AWWA D100-05, Section 3.3.1:

$$7,608/19,764 + 3,470/20,760 = 0.552 \leq 1.0 \text{ OK}$$

FIGURE C15.7-5 (Continued) Example Problem Using AWWA D100-05, Section 13.4.3.4

Unbraced multilegged tanks are uncommon. These types of tanks differ in their behavior, redundancy, and resistance to overload. Multilegged and small-diameter pedestal tanks have longer fundamental periods (typically greater than 2 s) than the shear wall type tanks (typically less than 2 s). The lateral load failure mechanisms usually are brace failure for multilegged tanks, compression buckling for small-diameter steel tanks, compression or shear buckling for large-diameter steel tanks, and shear failure for large-diameter

concrete tanks. Connection, welding, and reinforcement details require careful attention to mobilize the full strength of these structures. To provide a greater margin of safety, R factors used with elevated tanks typically are less than those for other comparable lateral load-resisting systems.

C15.7.10.4 Transfer of Lateral Forces into Support Tower.

The vertical loads and shears transferred at the base of a tank or vessel supported by grillage or beams typically vary around the base because of the relative stiffness of the supports, settlements, and variations in construction. Such variations must be considered in the design for vertical and horizontal loads.

C15.7.10.5 Evaluation of Structures Sensitive to Buckling Failure.

Nonbuilding structures that are designed with limited structural redundancy for lateral loads may be susceptible to total failure when loaded beyond the design loads. This phenomenon is particularly true for shell-type structures that exhibit unstable postbuckling behavior, such as tanks and vessels supported on shell skirts or pedestals. Evaluation for this critical condition ensures stability of the nonbuilding structure for governing design loads.

The design spectral response acceleration, S_a , used in this evaluation includes site factors. The I/R coefficient is taken as 1.0 for this critical check. The structural capacity of the shell is taken as the critical buckling strength (that is, the factor of safety is 1.0). Vertical and orthogonal combinations need not be considered for this evaluation because the probability of peak values occurring simultaneously is very low.

The intent of Section 15.7.10.5 and Table 15.4-2 is that skirt-supported vessels must be checked for seismic loads based on $I_e/R=1.0$ if the structure falls in Risk Category IV or if an R value of 3.0 is used in the design of the vessel. For the purposes of this section, a skirt is a thin-walled steel cylinder or cone used to support the vessel in compression. Skirt-supported vessels fail in buckling, which is not a ductile failure mode. Therefore, a more conservative design approach is required. The $I_e/R=1.0$ check typically governs the design of the skirt over using loads determined with an R factor of 3 in a moderate to high area of seismic activity. The only benefit of using an R factor of 3 in this case is in the design of the foundation. The foundation is not required to be designed for the $I_e/R=1.0$ load. Section 15.7.10.5, item b, states that resistance of the structure shall be defined as the critical buckling resistance of the element for the $I_e/R=1.0$ load. This stipulation means that the support skirt can be designed based on critical buckling (factor of safety of 1.0). The critical buckling strength of a skirt can be determined using a number of published sources. The two most common methods for determining the critical buckling strength of a skirt are the ASME BVPC (2007), Section VIII, Division 2, 2008 Addenda, Paragraph 4.4, using a factor of safety of 1.0 and AWWA D100-05 (2006a), Section 13.4.3.4. To use these methods, the radius, length, and thickness of the skirt; modulus of elasticity of the steel; and yield strength of the steel are required. These methods take into account both local buckling and slenderness effects of the skirt. Under no circumstance should the theoretical buckling strength of a cylinder, found in many engineering mechanics texts, be used to determine the critical buckling strength of the skirt. The theoretical value, based on a perfect cylinder, does not take into account imperfections built into real skirts. The theoretical buckling value is several times greater than the actual value measured in tests. The buckling values found in the suggested references above are based on actual tests.

Examples of applying the ASME BVPC (2007), Section VIII, Division 2, 2008 Addenda, Paragraph 4.4, and AWWA D100-05 (2006a), Section 13.4.3.4, buckling rules are shown in Figs. C15.7-4 and C15.7-5.

C15.7.10.7 Concrete Pedestal (Composite) Tanks.

A composite elevated water storage tank is composed of a welded steel tank for watertight containment, a single-pedestal concrete support structure, a foundation, and accessories. The lateral load-resisting system is a load-bearing concrete shear wall. ACI 371R (1998), referenced in previous editions of ASCE 7, has

been replaced with AWWA D107 (2010). Because AWWA D107-10 is based on the seismic design ground motions from ASCE 7-05, a requirement was added in Section 15.7.10.7 to require the use of the seismic design ground motions from Section 11.4.

C15.7.11 Boilers and Pressure Vessels.

The support system for boilers and pressure vessels must be designed for the seismic forces and displacements presented in the standard. Such design must include consideration of the support, the attachment of the support to the vessel (even if “integral”), and the body of the vessel itself, which is subject to local stresses imposed by the support connection.

C15.7.12 Liquid and Gas Spheres.

The commentary in Section C15.7.11 also applies to liquid and gas spheres.

C15.7.13 Refrigerated Gas Liquid Storage Tanks and Vessels.

Even though some refrigerated storage tanks and vessels, such as those storing liquefied natural gas, are required to be designed for ground motions and performance goals in excess of those found in the standard, all such structures must also meet the requirements of this standard as a minimum. All welded steel refrigerated storage tanks and vessels must be designed in accordance with the requirements of the standard and the requirements of API 620.

C15.7.14 Horizontal, Saddle-Supported Vessels for Liquid or Vapor Storage.

Past practice has been to assume that a horizontal, saddle-supported vessel (including its contents) behaves as a rigid structure (with natural period, T , less than 0.06 s). For this situation, seismic forces would be determined using the requirements of Section 15.4.2. For large horizontal, saddle-supported vessels (length-to-diameter ratio of 6 or more), this assumption can be unconservative, so Section 15.7.14.3 requires that the natural period be determined assuming the vessel to be a simply supported beam.

C15.8 CONSENSUS STANDARDS AND OTHER REFERENCED DOCUMENTS

Chapter 15 of this standard makes extensive use of reference documents in the design of nonbuilding structures for seismic forces; see Chapter 23. The documents referenced in Chapter 15 are industry documents commonly used to design specific types of nonbuilding structures. The vast majority of these reference documents contain seismic provisions that are based on the seismic ground motions of the 1997 Uniform Building Code (ICBO 1997) or earlier editions of the UBC. To use these reference documents, Chapter 15 modifies the seismic force provisions of these reference documents through the use of “bridging equations.” The standard only modifies industry documents that specify seismic demand and capacity. The bridging equations are intended to be used directly with the other provisions of the specific reference documents. Unlike the other provisions of the standard, if the reference documents are written in terms of allowable stress design, then the bridging equations are shown in allowable stress design format. In addition, the detailing requirements referenced in Tables 15.4-1 and Table 15.4-2 are expected to be followed, as well as the general requirements found in Section 15.4.1. The usage of reference documents in conjunction with the requirements of Section 15.4.1 are summarized in Table C15.8-1.

Table C15.8-1 Usage of Reference Documents in Conjunction with Section 15.4.1

Subject	Requirement
R , Ω_0 , and C_d values, detailing requirements, and height limits	Use values and limits in Tables 12.2-1, 15.4-1, or 15.4-2 as appropriate. Values from the reference document are not to be used.
Minimum base shear	Use the appropriate value from Eq. (15.4-1) or (15.4-2) for nonbuilding structures not similar to buildings. For structures containing liquids, gases, and granular solids supported at the base, the minimum seismic force cannot be less than that required by the reference document.
Importance Factor	Use the value from Section 15.4.1.1 based on Risk Category. Importance Factors from the reference document are not to be used unless they are greater than those provided in the standard.
Vertical distribution of lateral load	Use requirements of Section 12.8.3 or Section 12.9 or the applicable reference document.
Seismic provisions of reference documents	The seismic force provisions of reference documents may be used only if they have the same basis as Section 11.4 and the resulting values for total lateral force and total overturning moment are no less than 80% of the values obtained from the standard.
Load combinations	Load combinations specified in Section 2.3 (LRFD) or Section 15 (includes ASD load combinations of Section 2.4) must be used.

Currently, only four reference documents have been revised to meet the seismic requirements of the standard. AWWA D100, API 620, API 650, and ANSI/RMI MH 16.1 have been adopted by reference in the standard without modification, except that height limits are imposed on “elevated tanks on symmetrically braced legs (not similar to buildings)” in AWWA D100, and the anchorage requirements of Section 15.4.9 are imposed on steel storage racks in ANSI/RMI MH 16.1. Three of these reference documents apply to welded steel liquid storage tanks.

REFERENCES

- American Concrete Institute (ACI). (1997). “Standard practice for the design and construction of concrete silos and stacking tubes for storing granular materials,” *ACI 313*. Farmington Hills, MI.
- ACI. (1998). “Guide to the analysis, design, and construction of concrete-pedestal water towers,” *ACI 371R*. Farmington Hills, MI.
- ACI. (2006). “Seismic design of liquid-containing concrete structures,” *ACI 350.3-06*. Farmington Hills, MI.
- ACI. (2014). “Building code requirements for structural concrete and commentary,” *ACI 318*. Farmington Hills, MI.
- American Institute of Steel Construction (AISC). (1986). *Load and resistance factor design specification for structural steel buildings*, Chicago.

- AISC. (2016). “Seismic provisions for structural steel buildings,” *AISC 341*, Chicago.
- Anderson, P. F. (1966). “Temperature stresses in steel grain storage tanks.” *Civil Eng.* 36(1), 74.
- ASCE. (1984). “Guidelines for the seismic design of oil and gas pipeline systems.” ASCE, Reston, VA.
- ASCE/American Wind Energy Association (ASCE/AWEA). (2011). *Recommended practice for large land-based wind turbine support structures*. RP2011, ASCE, Reston, VA.
- ASCE/SEI. (1995). *Minimum design loads for buildings and other structures, 7-05, including Supplement 2*, ASCE, Reston, VA.
- ASCE/SEI. (2010). *Minimum design loads for buildings and other structures, 7-10, including Supplement 2*, ASCE, Reston, VA.
- American Society of Mechanical Engineers (ASME). (2007). *Boiler and pressure vessel code (BPVC)*, New York.
- ASME. (2011). “Steel stacks,” *ASME STS-1*, New York.
- ASTM International. (ASTM). (2015). “Standard specification for anchor bolts, steel, 36, 55, and 105-ksi yield strength,” *ASTM F1554*, West Conshohocken, PA.
- American Water Works Association (AWWA). (2005). “Welded steel tanks for water storage,” *AWWA D100*, Denver.
- AWWA. (2006a). “Welded steel tanks for water storage,” *AWWA D100-05*, American Water Works Association, Denver.
- AWWA. (2006b). “Tendon-prestressed concrete water tanks,” *American Water Works Association D115*, Denver.
- AWWA. (2011). “Welded steel tanks for water storage,” *American Water Works Association D100*, Denver.
- AWWA. (2009). “Factory-coated bolted steel tanks for water storage,” *American Water Works Association D103*, Denver.
- AWWA. (2010). “Composite elevated tanks for water storage,” *American Water Works Association D107*, Denver.
- AWWA. (2013). “Wire- and strandwound circular prestressed concrete water tanks,” *AWWA D110*, Denver.
- Chandrasekaran, A. R., and Jain, P. C. (1968). “Effective live load of storage materials under dynamic conditions.” *Ind. Concrete J.* 42(9), 364–365.
- Chandrasekaran, A. R., Saini, S. S., and Jhamb, I. C. (1968). “Live load effects on dynamic behavior of structures.” *J. Inst. Eng.*, 48, 850–859.
- Federal Emergency Management Agency (FEMA). (2005). “Seismic considerations for steel storage racks located in areas accessible to the public,” *FEMA 460*. Building Seismic Safety Council, National Institute of Building Sciences, Washington, DC.
- FEMA. (2009). “Quantification of Building Seismic Performance Factors,” *FEMA P695*, Applied Technology Council, Redwood City, CA.
- FEMA. (2012). “Reducing the risks of nonstructural earthquake damage—A practical guide.” *FEMA E-74*, Applied Technology Council, Redwood City, CA.

- Ferritto, J., Dickenson, S., Priestley, N., Werner, S., Taylor, C., and Burke, D., et al. (1999). "Seismic criteria for California marine oil terminals," Vols. 1 and 2, *Technical Report TR-2103-SHR*, Naval Facilities Engineering Service Center, Port Hueneme, CA.
- Hadjian, A.H. (1986). "On the decoupling of secondary systems for seismic analysis," *J. Pressure Vessel Technology* 108(1), 78-85 (Feb 01) doi:10.1115/1.3264755
- International Conference of Building Officials (ICBO). (1997). *Uniform building code*, Whittier, CA.
- Kaups, T., and Lieb, J. M. (1985). *A practical guide for the design of quality bulk storage bins and silos*, Chicago Bridge & Iron, Plainfield, IL.
- Kilic, S., and Sozen, M. (2003). "Evaluation of effect of August 17, 1999, Marmara earthquake on two tall reinforced concrete chimneys." *ACI Struct. J.*, 100(3), 357–364.
- Malhotra, P. K. (2005). "Sloshing loads in liquid-storage tanks with insufficient freeboard." *Earthq. Spectra*, 21(4), 1185–1192.
- Malhotra, P. K. (2006). "Earthquake induced sloshing in cone and dome roof tanks with insufficient freeboard." *J. Struct. Eng. Intl., IABSE*, 16(3), 222–225.
- Malhotra, P. K., Wenk, T., and Wieland, M. (2000). "Simple procedure for seismic analysis of liquid-storage tanks." *J. Struct. Eng. Intl, IABSE*, 10(3), 197–201.
- Marine oil terminal engineering and maintenance standards . (2005). Title 24, Part 2, California Building Code, Chapter 31F.
- Miller, C. D., Meier, S. W., and Czaska, W. J. (1997). *Effects of internal pressure on axial compressive strength of cylinders and cones*. Paper presented at the Structural Stability Research Council Annual Technical Meeting, June.
- Priestley, M. J. N., Siebel, F., and Calvi, G. M. (1996). *Seismic design and retrofit of bridges*, New York.
- Rack Manufacturers Institute (RMI). (2012). "Specification for the design, testing, and utilization of industrial steel storage racks," *ANSI/RMI MH 16.1*, Charlotte, NC.
- RMI. (2016). "Specification for the design, testing, and utilization of industrial steel cantilevered storage racks," *ANSI/RMI MH 16.3*, Charlotte, NC.
- Seismic design guidelines for port structures . (2001). Working Group No. 34 of the Maritime Navigation Commission
- Trahair, M. S., Abel, A., Ansourian, P., Irvine, H. M., and Rotter, J. M. (1983). *Structural design of steel bins for bulk solids* . Australian Institute of Steel Construction, Sydney.
- Troitsky, M. S. (1990). *Tubular steel structures—Theory and design* . The James F. Lincoln Arc Welding Foundation, Mentor, OH.
- U.S. Department of Energy. (1963). "Nuclear reactors and earthquakes." *TID-7024*, U.S. Atomic Energy Commission, Washington, DC.
- Veletsos, A. S. (1974). "Seismic effects in flexible liquid-storage tanks." *In Proc. 5th World Conference on Earthquake Engineering, Rome*, 630–639.
- Werner, S. D., ed. (1998). *Seismic guidelines for ports*, Monograph No. 12, ASCE, Reston, VA.
- Wey, E. H., & Mejia, F. (2019). *Factors triggering combined analysis of coupled industrial structures subjected to seismic loading*. Proceedings of the 2019 Structures Congress[pending].

Wozniak, R. S., and Mitchell, W. W. (1978). *Basis of seismic design provisions for welded steel oil storage tanks*. Presented at the Session on Advances in Storage Tank Design, American Petroleum Institute, Refining, 43rd Midyear Meeting, Toronto, May 9.

OTHER REFERENCES (NOT CITED)

American Concrete Institute (ACI). (2008), “Code requirements for reinforced concrete chimneys and commentary,” *ACI 307*. Farmington Hills, MI.

American Petroleum Institute (API). (2014a). “Design and construction of large, welded, low pressure storage tanks, 12th Ed. Addendum 1,” *API 620*, Washington, DC.

API. (2014b). “Welded steel tanks for oil storage, 12th Ed., Addendum 1,” *API 650*, Washington, DC.

API. (2014c). “Tank, inspection, repair, alteration, and reconstruction, 5th Ed.,” *API 653*, Washington, DC.

API. (2014d). “Specification for bolted tanks for storage of production liquids, 16th Ed.,” *API 12B*, Washington, DC.

ASCE. (1997). *Design of secondary containment in petrochemical facilities*, Reston, VA.

ASCE. (2011). *Guidelines for seismic evaluation and design of petrochemical facilities, 2nd Ed.*, Reston, VA.

Drake, R. M., and Walter, R. J. (2010). “Design of structural steel pipe racks,” *AISC Eng. J.*, 4th Quarter, 241–251.

International Conference of Building Officials (ICBO). (1988). *Uniform building code*, Whittier, CA.

National Fire Protection Association (NFPA). (2013). “Standard for the production, storage, and handling of liquefied natural gas (LNG),” *NFPA 59A*, Quincy, MA.

Soules, J. G., *The seismic provisions of the 2006 IBC – Nonbuilding structure criteria*, Proc. 8th National Conference on Earthquake Engineering, San Francisco, April 18, 2006.

COMMENTARY TO CHAPTER 16, SEISMIC RESPONSE HISTORY PROCEDURES

C16.1 GENERAL REQUIREMENTS

C16.1.1 Scope.

Response history analysis is a form of dynamic analysis in which response of the structure to a suite of ground motions is evaluated through numerical integration of the equations of motions. In nonlinear response history analysis, the structure's stiffness matrix is modified throughout the analysis to account for the changes in element stiffness associated with hysteretic behavior and P-delta effects. When nonlinear response history analysis is performed, the R , C_d , and Ω_0 coefficients considered in linear procedures are not applied because the nonlinear analysis directly accounts for the effects represented by these coefficients.

Nonlinear response history analysis is permitted to be performed as part of the design of any structure and is specifically required to be performed for the design of certain structures incorporating seismic isolation or energy dissipation systems. Nonlinear response history analysis is also frequently used for the design of structures that use alternative structural systems or do not fully comply with the prescriptive requirements of the standard in one or more ways. Before this edition, ASCE 7 specified that nonlinear response history analyses be performed using ground motions scaled to the design earthquake level and that design acceptance checks be performed to ensure that mean element actions do not exceed two-thirds of the deformations at which loss of gravity-load-carrying capacity would occur. In this edition of ASCE 7, a complete reformulation of these requirements was undertaken to require analysis at the Risk-Targeted Maximum Considered Earthquake (MCE_R) level and also to be more consistent with the target reliabilities indicated in Section 1.3.1.3.

The target collapse reliabilities given in Table 1.3-2 are defined such that, when a building is subjected to MCE_R ground motion, not greater than a 10% probability of collapse exists for Risk Category I and II structures. For Risk Category III and IV structures, these maximum collapse probabilities are reduced to 5% and 2.5%, respectively.

There are additional performance expectations for Risk Category III and IV structures that go beyond the collapse safety performance goals (e.g., limited damage and postearthquake functionality for lower ground motion levels). These enhanced performance goals are addressed in this chapter by enforcing an $I_e > 1.0$ in the linear design step (which is consistent with the approach taken in the other design methods of Chapter 12) and also by considering in acceptance checks specified in Section 16.4.

It is conceptually desirable to create a Chapter 16 response history analysis (RHA) design process that explicitly evaluates the collapse probability and ensures that the performance goal is fulfilled. However, explicit evaluation of collapse safety is a difficult task requiring (a) a structural model that is able to directly simulate the collapse behavior, (b) use of numerous nonlinear response history analyses, and (c) proper treatment of many types of uncertainties. This process is excessively complex and lengthy for practical use in design. Therefore, Chapter 16 maintains the simpler approach of *implicitly* demonstrating adequate performance through a prescribed set of analysis rules and acceptance criteria. Even so, this implicit approach does not preclude the use of more advanced procedures that explicitly demonstrate that a design fulfills the collapse safety goals. Such more advanced procedures are permitted by Section 1.3.1.3 of this standard. An example of an advanced explicit procedure is the building-specific collapse assessment methodology in Appendix F of FEMA P-695 (FEMA 2009b).

C16.1.2. Linear Analysis.

As a precondition to performing nonlinear response history analysis, a linear analysis in accordance with the requirements of Chapter 12 is required. Any of the linear procedures allowed in Chapter 12 may be used. The purpose of this requirement is to ensure that structures designed using nonlinear response history analyses meet the minimum strength and other criteria of Chapter 12, with a few exceptions. In particular, when performing the Chapter 12 evaluations it is permitted to take the value of Ω_0 as 1.0 because it is felt that values of demand obtained from the nonlinear procedure is a more accurate representation of the maximum forces that will be delivered to critical elements, considering structural overstrength, than does the application of the judgmentally derived factors specified in Chapter 12. Similarly, it is permitted to use a value of 1.0 for the redundancy factor, ρ , because it is felt that the inherent nonlinear evaluation of response to MCE_R shaking required by this chapter provides improved reliability relative to the linear procedures of Chapter 12. For Risk Category I, II, and III structures, it is permitted to neglect the evaluation of story drift when using the linear procedure because it is felt that the drift evaluation performed using the nonlinear procedure provides a more accurate assessment of the structure's tolerance to earthquake-induced drift. However, linear drift evaluation is required for Risk Category IV structures because it is felt that this level of drift control is important to attaining the enhanced performance desired for such structures.

As with other simplifications permitted in the linear analysis required under this section, it is also permitted to use a value of 1.0 for the torsional amplification, A_x , when performing a nonlinear analysis if accidental torsion is explicitly modeled in the nonlinear analysis. Although this does simplify the linear analysis somewhat, designers should be aware that the resulting structure may be more susceptible to torsional instability when performing the nonlinear analysis. Therefore, some designers may find it expedient to use a value of A_x consistent with the linear procedures as a means of providing a higher likelihood that the nonlinear analysis will result in acceptable outcomes.

C16.1.3 Vertical Response Analysis.

Most structures are not sensitive to the effects of response to vertical ground shaking, and there is little evidence of the failure of structures in earthquakes resulting from vertical response. However, some nonbuilding structures and building structures with long spans, cantilevers, prestressed construction, or vertical discontinuities in their gravity-load-resisting systems can experience significant vertical earthquake response that can cause failures. The linear procedures of Chapter 12 account for these effects in an approximate manner through use of the $0.2S_{DS}D$ term in the load combinations. When nonlinear response history analysis is performed for structures with sensitivity to vertical response, direct simulation of this response is more appropriate than use of the approximate linear procedures. However, in order to properly capture vertical response to earthquake shaking, it is necessary to accurately model the stiffness and distribution of mass in the vertical load system, including the flexibility of columns and horizontal framing. This effort can considerably increase the complexity of analytical models. Rather than requiring this extra effort in all cases where vertical response can be significant, this chapter continues to rely on the approximate approach embedded in Chapter 12 for most cases. However, where the vertical load path is discontinuous and where vertical response analysis is required by Chapter 15, Chapter 16 does require explicit modeling and analysis of vertical response. Since in many cases the elements sensitive to vertical earthquake response are not part of the seismic force-resisting system, it is often possible to decouple the vertical and lateral response analyses, using separate models for each.

Appropriate accounting for the effects of vertical response to ground shaking requires that horizontal framing systems, including floor and roof systems, be modeled with distributed masses and sufficient vertical degrees of freedom to capture their out-of-plane dynamic characteristics. This increased fidelity in modeling of the structure's vertical response characteristics will significantly increase the size and complexity of models. As a result, the chapter requires direct simulation of vertical response only for certain

structures sensitive to those effects and relies on the procedures of Chapter 12 to safeguard the vertical response of other structures.

C16.1.4 Documentation.

By its nature, most calculations performed using nonlinear response history analysis are contained within the input and output of computer software used to perform the analysis. This section requires documentation, beyond the computer input and output, of the basic assumptions, approaches, and conclusions so that thoughtful review may be performed by others including peer reviewers and the authority having jurisdiction. This section requires submittal and review of some of these data before the analyses are performed in order to ensure that the engineer performing the analysis/design and the reviewers are in agreement before substantive work is performed.

C16.2 GROUND MOTIONS

C16.2.1 Target Response Spectrum.

The target response spectrum used for nonlinear dynamic analysis is the maximum direction MCE_R spectrum determined in accordance with Chapter 11 or Chapter 21. Typical spectra determined in accordance with those procedures are derived from uniform hazard spectra (UHSs) and modified to provide a uniform risk spectrum (URS), or alternatively, a deterministic MCE spectrum. UHSs have been used as the target spectra in design practice since the 1980s. The UHS is created for a given hazard level by enveloping the results of seismic hazard analysis for each period (for a given probability of exceedance). Accordingly, it is generally a conservative target spectrum if used for ground motion selection and scaling, especially for large and rare ground motions, unless the structure exhibits only elastic first-mode response. This inherent conservatism comes from the fact that the spectral values at each period are not likely to all occur in a single ground motion. This limitation of the UHS has been noted for many years (e.g., Bommer et al. 2000; Naem and Lew 1995; Reiter 1990). The same conservatism exists for the URS and deterministic MCE spectra that serves as the basis for Method 1.

Method 2 uses the conditional mean spectrum (CMS), an alternative to the URS that can be used as a target for ground motion selection in nonlinear response history analysis (e.g., Baker and Cornell 2006; Baker 2011; Al Atik and Abrahamson 2010).

To address the conservatism inherent in analyses using URSs as a target for ground motion selection and scaling, the CMS instead conditions the spectrum calculation on a spectral acceleration at a single period and then computes the mean (or distribution of) spectral acceleration values at other periods. This conditional calculation ensures that the resulting spectrum is reasonably likely to occur and that ground motions selected to match the spectrum have an appropriate spectral shape consistent with naturally occurring ground motions at the site of interest. The calculation is no more difficult than the calculation of a URS and is arguably more appropriate for use as a ground motion selection target in risk assessment applications. The spectrum calculation requires disaggregation information, making it a site-specific calculation that cannot be generalized to other sites. It is also period-specific, in that the conditional response spectrum is conditioned on a spectral acceleration value at a specified period. The shape of the conditional spectrum also changes as the spectral amplitude changes (even when the site and period are fixed). Figure C16.2-1 provides examples of CMSs for an example site in Palo Alto, California, anchored at four different candidate periods. The UHS for this example site is also provided for comparison.

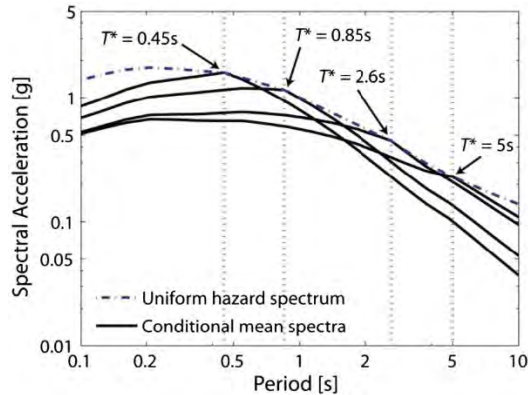

FIGURE C16.2-1 Example Conditional Mean Spectra for a Palo Alto Site Anchored for 2% in 50-Year Motion at $T^* = 0.45s$, $0.85s$, $2.6s$, and $5s$

Source: NIST 2011

As previously discussed, the URS is a conservative target spectrum for ground motion selection, and the use of CMS target spectra is more appropriate for representing anticipated MCE_R ground motions at a specified period. A basic CMS-type approach was used in the analytical procedures of the FEMA P-695 (FEMA 2009b) project, the results of which provided the initial basis for establishing the 10% probability of collapse goal shown in Table 1.3-2. Therefore, the use of CMS target spectra in the Chapter 16 RHA design procedure is also internally consistent with how the collapse probability goals of Table 1.3-2 were developed.

The URS (or deterministic MCE) target spectrum is retained in Section 16.2.1.1 (as a simpler and more conservative option) as the specified target spectrum, and the CMS is permitted as an alternate in Section 16.2.1.2. Whereas CMS appropriately captures the earthquake energy and structural response at a particular period resulting from a particular scenario earthquake, it is not capable of capturing the MCE_R level response associated with other scenarios that are component to the MCE_R spectrum. Therefore, when using CMS, it may be necessary to use several conditioning periods and associated targets to develop conditional mean spectra in order to fully capture the structure's response to different earthquake scenarios. The recommended procedure includes the following steps for creating the site-specific scenario response spectra.

1. Select those periods that correspond to periods of vibration that significantly contribute to the building's inelastic dynamic response. This selection includes a period near the fundamental period of the building, or perhaps a slightly extended period to account for inelastic period lengthening (e.g., $1.5T_1$). In buildings where the fundamental response periods in each of two orthogonal axes is significantly different, a conditioning period associated with each direction is needed. It also likely requires periods near the translational second-mode periods. When selecting these significant periods of response, the elastic periods of response should be considered (according to the level of mass participation for each of these periods), and the amount of first-mode period elongation caused by inelastic response effects should also be considered.
2. For each period selected above, create a scenario spectrum that matches or exceeds the MCE_R value at that period. When developing the scenario spectrum, (a) perform site-specific disaggregation to identify earthquake events likely to result in MCE_R ground shaking, and then (b) develop the scenario spectrum to capture one or more spectral shapes for dominant magnitude and distance combinations revealed by the disaggregation.

3. Enforce that the envelope of the scenario spectra not be less than 75% of the MCE_R spectrum (from Method I) for any period within the period range of interest (as defined in Section 16.2.3.1).

After the target spectra are created, each target response spectrum is then used in the remainder of the response history analyses process and the building must be shown to meet the acceptance criteria for each of the scenarios.

The primary purpose of the 75% floor value is to provide a basis for determining how many target spectra are needed for analysis. For small period ranges, fewer targets are needed, and more target spectra are needed for buildings where a wider range of periods are important to the structural response (e.g., taller buildings). When creating the target spectra, some spectral values can also be artificially increased to meet the requirements of this 75% floor. A secondary reason for the 75% floor is to enforce a reasonable lower bound. The specific 75% threshold value was determined using several examples; the intention is that this 75% floor requirement will be fulfilled through the use of two target spectra in most cases. From the perspective of collapse risk, the requirement of being within 75% of the MCE_R at all periods may introduce some conservatism, but the requirement adds robustness to the procedure by ensuring that the structure is subjected to ground motions with near- MCE_R -level intensities at all potentially relevant periods. Additionally, this requirement ensures that demands unrelated to collapse safety, such as higher mode-sensitive force demands, can be reasonably determined from the procedure.

C16.2.2 Ground Motion Selection.

Before this edition of ASCE 7, Chapter 16 required a minimum of three ground motions for nonlinear response history analysis. If three ground motions were used, the procedures required evaluation of structural adequacy using the maximum results obtained from any of the ground motions. If seven or more motions were used, mean results could be used for evaluation. Neither three nor seven motions are sufficient to accurately characterize either mean response or the record-to-record variability in response. In the 2016 edition of the standard, the minimum number of motions was increased to 11. The requirement for this larger number of motions was not based on detailed statistical analyses, but rather was judgmentally selected to balance the competing objectives of more reliable estimates of mean structural responses (through use of more motions) against computational effort (reduced by using fewer motions). An advantage of using this larger number of motions is that if unacceptable response is found for more than one of the 11 motions, this does indicate a significant probability that the structure will fail to meet the 10% target collapse reliability for Risk Category I and II structures of Section 1.3.1.3. This advantage is considered in the development of acceptance criteria discussed in Section C16.4.

All real ground motions include three orthogonal components. For most structures, it is only necessary to consider response to horizontal components of ground shaking. However, consideration of vertical components is necessary for structures defined as sensitive to vertical earthquake effects.

Section 11.4.1 defines near-fault sites as sites located within 9.3 mi (15 km) of the surface projection of faults capable of producing earthquakes of magnitude 7.0 or greater and within 6.2 mi (10 km) of the surface projection of faults capable of producing earthquakes of magnitude 6.0 or greater, where the faults must meet minimum annual slip rate criteria. Such near-fault sites have a reasonable probability of experiencing ground motions strongly influenced by rupture directivity effects. These effects can include pulse-type ground motions (e.g., Shahi et al. 2011) observable in velocity histories and polarization of ground motions such that the maximum direction of response tends to be in the direction normal to the fault strike. The issue of pulse-type ground motions affects the manner by which individual ground motions are selected for the site and applied to the structure.

Selection of Ground Motions for Sites That Are Not Near-Fault. The traditional approach has been to select (and/or simulate) ground motions that have magnitudes, fault distances, source mechanisms, and site soil

conditions that are roughly similar to those likely to cause the ground motion intensity level of interest (e.g., Stewart et al. 2002) and not to consider the spectral shape in the ground motion selection. In many cases, the response spectrum is the property of a ground motion most correlated with the structural response (Bozorgnia et al. 2009) and should be considered when selecting ground motions. When spectral shape is considered in the ground motion selection, the allowable range of magnitudes, distances, and site conditions can be relaxed so that a sufficient number of ground motions with appropriate spectral shapes are available.

The selection of recorded motions typically occurs in two steps, as explained in the following illustration. Step 1 involves preselecting the ground motion records in the database (e.g., Anchenta et al. 2015) that have reasonable source mechanisms, magnitude, site soil conditions, range of usable frequencies, and site-to-source distance. In completing this preselection, it is permissible to use relatively liberal ranges because Step 2 can involve selecting motions that provide good matches to a target spectrum of interest (and matching to a target spectrum tends to implicitly account for many of the above issues). Step 2 in the selection process is to select the final set of motions from those preselected in Step 1.

In the first step, the following criteria should be used to filter out ground motions that should not be considered as candidates in the final selection process:

- **Source Mechanism:** Ground motions from differing tectonic regimes (e.g., subduction versus active crustal regions) often have substantially differing spectral shapes and durations, so recordings from appropriate tectonic regimes should be used whenever possible.
- **Magnitude:** Earthquake magnitude is related to the duration of ground shaking, so using ground motions from earthquakes with appropriate magnitudes should already have approximately the appropriate durations. Earthquake magnitude is also related to the shape of the resulting ground motion's response spectrum, though spectral shape is considered explicitly in Step 2 of the process, and so this is not a critical factor when identifying ground motions from appropriate magnitude earthquakes.
- **Site Soil Conditions:** Site soil conditions (Site Class) exert a large influence on ground motions but are already reflected in the spectral shape used in Step 2. For Step 1, reasonable limits on site soil conditions should be imposed but should not be too restrictive as to unnecessarily limit the number of candidate motions.
- **Usable Frequency of the Ground Motion:** Only processed ground motion records should be considered for RHA. Processed motions have a usable frequency range; in active regions, the most critical parameter is the lowest usable frequency. It is important to verify that the usable frequencies of the record (after filtering) accommodate the range of frequencies important to the building response; this frequency (or period) range is discussed in this next section on scaling.
- **Period/Frequency Sampling:** Ground motion recordings are discretized representations of continuous functions. The sampling rate for the recorded data can vary from as little as 0.001 seconds to as much as 0.02 seconds depending on the recording instrument and processing. If the sampling rate is too coarse, important characteristics of the motion, particularly in the high-frequency range, can be lost. On the other hand, the finer the sampling rate, the longer the analysis will take. Particularly for structures with significant response at periods less than 0.1 second, caution should be used to ensure that the sampling rate is sufficiently fine to capture the motion's important characteristics. As a general guideline, discretization should include at least 100 points per decade of significant response. Thus, for a structure with significant response at a period of 0.1 second, time steps should not be greater than 0.001 second.
- **Site-to-Source Distance:** The distance is a lower priority parameter to consider when selecting ground motions. Studies investigating this property have all found that response history analyses performed using ground motions from different site-to-source distances but otherwise equivalent properties produce practically equivalent demands on structures.

Once the preselection process has been completed, Step 2 is undertaken to select the final set of ground motions according to the following criteria:

- **Spectral Shape:** The shape of the response spectrum is a primary consideration when selecting ground motions.
- **Scale Factor:** It is also traditional to select motions such that the necessary scale factor is limited; an allowable scale factor limit of approximately 0.25 to 4 is not uncommon.
- **Maximum Motions from a Single Event:** Many also think it important to limit the number of motions from a single seismic event, such that the ground motion set is not unduly influenced by the single event. This criterion is deemed less important than limiting the scale factor, but imposing a limit of only three or four motions from a single event would not be unreasonable for most cases.

Further discussion of ground motion selection is available in NIST GCR 11-917-15 (NIST 2011), *Selecting and Scaling Earthquake Ground Motions for Performing Response-History Analyses*.

Near-fault sites have a probability of experiencing pulse-type ground motions. This probability is not unity, so only a certain fraction of selected ground motions should exhibit pulslike characteristics, while the remainder can be nonpulse records selected according to the standard process described above. The probability of experiencing pulslike characteristics is dependent principally on (1) distance of site from fault; (2) fault type (e.g., strike slip or reverse); and (3) location of hypocenter relative to site, such that rupture occurs toward or away from the site.

Criteria (1) and (2) are available from conventional disaggregation of probabilistic seismic hazard analysis. Criterion (3) can be computed as well in principal but is not generally provided in a conventional hazard analysis. However, for the long ground motion return periods associated with MCE_R spectra, it is conservative and reasonable to assume that the fault rupture is toward the site for the purposes of evaluating pulse probabilities. Empirical relations for evaluating pulse probabilities in consideration of these criteria are given in NIST GCR 11-917-15 (2011) and in Shahi et al. (2011).

Once the pulse probability is identified, the proper percentage of pulslike records should be enforced in the ground motion selection. For example, if the pulse probability is 30% and 11 records are to be used, then 3 or 4 records in the set should exhibit pulslike characteristics in at least one of the horizontal components. The PEER Ground Motion Database can be used to identify records with pulse-type characteristics. The other criteria described in the previous section should also be considered to identify pulslike records that are appropriate for a given target spectrum and set of disaggregation results.

C16.2.3 Ground Motion Modification.

Two procedures for modifying ground motions for compatibility with the target spectrum are available: amplitude scaling and spectral matching. Amplitude scaling consists of applying a single scaling factor to the entire ground motion record such that the variation of earthquake energy with structural period found in the original record is preserved. Amplitude scaling preserves record-to-record variability; however, individual ground motions that are amplitude scaled can significantly exceed the response input of the target spectrum at some periods, which can tend to overstate the importance of higher mode response in some structures. In spectral matching techniques, shaking amplitudes are modified by differing amounts at differing periods, and in some cases additional wavelets of energy are added to or subtracted from the motions, such that the response spectrum of the modified motion closely resembles the target spectrum. Some spectral matching techniques are incapable of preserving important characteristics of velocity pulses in motions and should not be used for near-fault sites where these effects are important. Spectral matching does not generally preserve the record-to-record response variability observed when evaluating a structure for unmodified motions, but it can capture the mean response well, particularly if nonlinear response is moderate.

Vertical response spectra of earthquake records are typically significantly different than the horizontal spectra. Therefore, regardless of whether amplitude scaling or spectral matching is used, separate scaling of horizontal and vertical effects is required.

C16.2.3.1 Period Range for Scaling or Matching.

The period range for scaling of ground motions is selected such that the ground motions accurately represent the MCE_R hazard at the structure's fundamental response periods, periods somewhat longer than this to account for period lengthening effects associated with nonlinear response and shorter periods associated with a higher mode response. Before the 2016 edition of the standard, ground motions were required to be scaled between periods of $0.2T$ and $1.5T$. The lower bound was selected to capture higher mode response, and the upper bound, period elongation effects. In the 2016 edition, nonlinear response history analyses are performed at the MCE_R ground motion level. Greater inelastic response is anticipated at this level as compared to the design spectrum, so the upper bound period has accordingly been raised from $1.5T$ to $2.0T$, where T is redefined as the *maximum* fundamental period of the building (i.e., the maximum of the fundamental periods in both translational directions and the fundamental torsional period). This increase in the upper bound period is also based on recent research, which has shown that the $1.5T$ limit is too low for assessing ductile frame buildings subjected to MCE_R motions (Haselton and Baker 2006).

For the lower bound period, the $0.2T$ requirement is now supplemented with an additional requirement that the lower bound also should capture the periods needed for 90% mass participation in both directions of the building. This change is made to ensure that when used for tall buildings and other long-period structures, the ground motions are appropriate to capture response in higher modes that have significant response.

In many cases, the substructure is included in the structural model, and this inclusion substantially affects the mass participation characteristics of the system. Unless the foundation system is being explicitly designed using the results of the response history analyses, the above 90% modal mass requirement pertains only to the superstructure behavior; the period range does not need to include the very short periods associated with the subgrade behavior.

C16.2.3.2 Amplitude Scaling.

This procedure is similar to those found in earlier editions of the standard, but with the following changes:

1. Scaling is based directly on the maximum direction spectrum, rather than the square root of the sum of the squares spectrum. This change was made for consistency with the MCE_R ground motion now being explicitly defined as a maximum direction motion.
2. The approach of enforcing that the average spectrum “does not fall below” the target spectrum is replaced with requirements that (a) the average spectrum “matches the target spectrum” and (b) the average spectrum does not fall below 90% of the target spectrum for any period within the period range of interest. This change was made to remove the conservatism associated with the average spectrum being required to *exceed* the target spectrum at *every* period within the period range.

The scaling procedure requires that a maximum direction response spectrum be constructed for each ground motion. For some ground motion databases, this response spectrum definition is already precomputed and publicly available (e.g., for the Ancheta 2012). The procedure basically entails computing the maximum acceleration response to each ground motion pair for a series of simple structures that have a single mass. This procedure is repeated for structures of different periods, allowing construction of the spectrum. A number of software tools can automatically compute this spectrum for a given time–history pair.

Figure C16.2-2 shows an example of the scaling process for an example site and structure. This Figure shows how the average of the maximum direction spectra meets the target spectrum (a) and shows more detail for a single Loma Prieta motion in the scaled ground motion set (b).

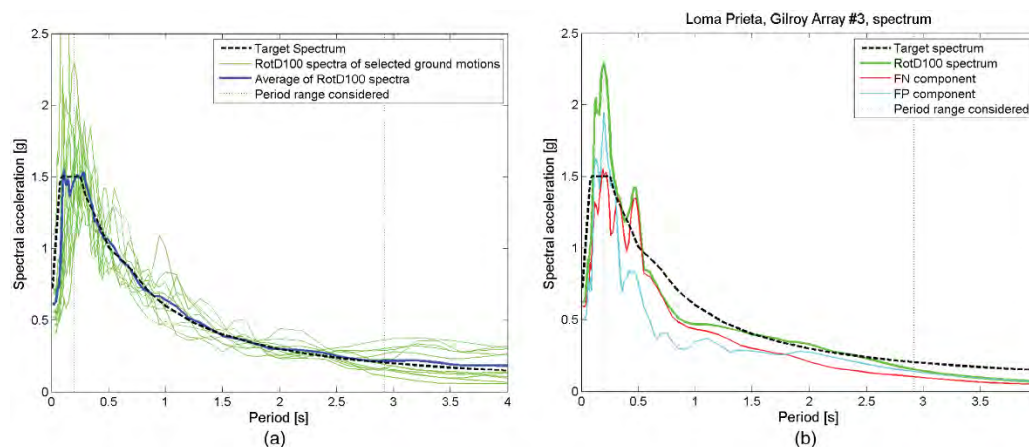

FIGURE C16.2-2 Ground Motion Scaling for an Example Site and Structure, Showing (a) the Ground Motion Spectra for All 11 Motions and (b) an Example for the Loma Prieta, Gilroy Array #3 Motion

C16.2.3.3 Spectral Matching.

Spectral matching of ground motions is defined as the modification of a real recorded earthquake ground motion in some manner such that its response spectrum matches a desired target spectrum across a period range of interest. There are several spectral matching procedures in use, as described in the NIST GCR 11-917-15 report (NIST 2011). The recommendations in this report should be followed regarding appropriate spectral matching techniques to be applied.

This section requires that when spectral matching is applied, the average of the maximum direction spectra of the matched motions must exceed the target spectrum over the period range of interest; this is intentionally a more stringent requirement, as compared to the requirement for scaled unmatched motions, because the spectral matching removes variability in the ground motion spectra and also has the potential to predict lower mean response (e.g., Luco and Bazzurro 2007; Grant and Diaferia 2012).

The specific technique used to perform spectral matching is not prescribed. It is possible to match both components of motion to a single target spectrum or to match the individual components to different spectra, as long as the average maximum direction spectra for the matched records meets the specified criteria.

Spectral matching is not allowed for near-fault sites, unless the pulse characteristics of the ground motions are retained after the matching process has been completed. This is based on the concern that, when common spectral matching methods are used, the pulse characteristics of the motions may not be appropriately retained.

C16.2.4 Application of Ground Motions to the Structural Model.

This section explains the guidelines for ground motion application for both non-near-fault and near-fault sites.

Sites That Are Not Near-Fault. In this standard, the maximum direction spectral acceleration is used to describe the ground motion intensity. This spectral acceleration definition causes a perceived directional dependence to the ground motion. However, the direction in which the maximum spectral acceleration occurs is random at distances beyond 5 km (3.1 mi) from the fault (Huang et al. 2008), does not necessarily align with a principal direction of the building, and is variable from period to period. Accordingly, for the

analysis to result in an unbiased prediction of structural response, the ground motions should be applied to the structure in a random orientation to avoid causing a biased prediction of structural response. True random orientation is difficult to achieve. Instead, the standard specifies that the average of the spectra applied in each direction should be similar to each other, such that unintentional bias in the application of motion, with one building axis experiencing greater demand than the other, is avoided.

Near-Fault Sites. Some recorded ground motions obtained from instruments located near zones of fault rupture have exhibited motion of significantly different character in one direction than the other. When this effect, known as directionality, occurs, it is common for the component of motion perpendicular to the fault to be stronger than that parallel to the fault and also for the fault-normal component to exhibit large velocity pulses. Sites located close to faults and that can experience motion having these characteristics are termed near-fault in this standard. For such sites, the fault-normal and fault-parallel components of recorded ground motions should be maintained and applied to the corresponding orientations of the structure.

It is important to note that not all near-fault records exhibit these characteristics and also that when records do have these characteristics the direction of maximum motion is not always aligned perpendicular to the fault strike. If appropriate selection of records is performed, some of the records used in the analysis should have these characteristics and some not. For those records that do exhibit directionality, the direction of strong shaking is generally aligned at varying azimuths, as occurred in the original recordings. It is also important to note that because ground motions have considerable variability in their characteristics, it is specifically not intended that buildings be designed weaker in the fault-parallel direction than in the fault-normal direction.

C16.3 MODELING AND ANALYSIS

C16.3.1 Modeling.

Nonlinear response history analysis offers several advantages over linear response history analysis, including the ability to model a wide variety of nonlinear material behaviors, geometric nonlinearities (including P-delta and large displacement effects), gap opening and contact behavior, and nonlinear viscous damping, and to identify the likely spatial and temporal distributions of inelasticity. Nonlinear response history analysis has several disadvantages, including increased effort to develop the analytical model, increased time to perform the analysis (which is often complicated by difficulties in obtaining converged solutions), sensitivity of computed response to system parameters, large amounts of analysis results to evaluate, and the inapplicability of superposition to combine live, dead, and seismic load effects.

While computation of collapse probability is not necessary, it is important to note that mathematical models used in the analysis should have the capability to determine if collapse occurs when the structure is subjected to MCE_R level ground motions. The ability to predict collapse is important because the global acceptance criteria in Section 16.4.1.1 allow collapse (or unacceptable response) to occur for only one of the 11 ground motions for Risk Category I and II buildings and allows no such responses for Risk Category III and IV buildings. Development of models with the ability to predict collapse requires attributes such as cyclic loss of strength and stiffness, low cycle fatigue failure, and geometric nonlinearity.

Although analytical models used to perform linear analysis in accordance with Chapter 12 typically do not include representation of elements other than those that compose the intended lateral-force-resisting system, the gravity-load-carrying system and some nonstructural components can add significant stiffness and strength. Because the goal of nonlinear response history analysis is to accurately predict the building's probable performance, it is important to include such elements in the analytical model and also to verify that the behavior of these elements will be acceptable. This inclusion may mean that contribution of stiffness and strength from elements considered as nonparticipating elements in other portions of this standard should be included in the response history analysis model. Since structures designed using nonlinear response history analysis must also be evaluated using linear analyses, this analysis ensures that the strength of the

intended seismic force-resisting system is not reduced relative to that of structures designed using only the linear procedures.

Expected material properties are used in the analysis model, attempting to characterize the expected performance as closely as possible. It is suggested that expected properties be selected considering actual test data for the proposed elements. Where test data are not readily available, the designer may consider estimates as found in ASCE 41 and the PEER TBI Guidelines (Bozorgnia et al. 2009). Guidance on important considerations in modeling may also be found in *Nonlinear Structural Analysis for Seismic Design*, NIST GCR 10-917-5 (NIST 2010).

Two-dimensional structural models may be useful for initial studies and for checking some specific issues in a structure; however, the final structural model used to confirm the structural performance should be three-dimensional.

For certain structures, the response under both horizontal and vertical ground motions should be considered. NIST GCR 11-917-15 (NIST 2011) provides some guidance to designers considering the application of vertical ground motions. To properly capture the nonlinear dynamic response of structures where vertical dynamic response may have a significant influence on structural performance, it is necessary to include vertical mass in the mathematical model. Typically the vertical mass must be distributed across the floor and roof plates to properly capture vertical response modes. Additional degrees of freedom (e.g., nodes at quarter points along the span of a beam) need to be added to capture this effect, or horizontal elements need to be modeled with consistent mass. Numerical convergence problems caused by large oscillatory vertical accelerations have been noted (NIST 2012) where base rotations caused by wall cracking in fiber wall models are the primary source of vertical excitation. See also the Commentary on Chapter 22.

Consideration of the additional vertical load of $(0.2S_{DS}) * D$, per Section 12.4.2, is inappropriate for response history analysis. Response history analyses are desired to reflect actual building response to the largest extent possible. Applying an artificial vertical load to the analysis model before application of a ground motion results in an offset in the yield point of elements carrying gravity load because of the initial artificial stress. Similarly, applying an artificial vertical load to the model at the conclusion of a response history analysis is not indicative of actual building response. If vertical ground motions are expected to significantly affect response, application of vertical shaking to the analysis model is recommended. It should be noted that vertical response often occurs at higher frequencies than lateral response, and hence, a finer analysis time-step might be required when vertical motions are included.

For structures composed of planar seismic force-resisting elements connected by floor and roof diaphragms, the diaphragms should be modeled as semirigid in plane, particularly where the vertical elements of the seismic force-resisting system are of different types (such as moment frames and walls). Biaxial bending and axial force interaction should be considered for corner columns, nonrectangular walls, and other similar elements.

Nonlinear response history analysis is load path dependent, with the results depending on combined gravity and lateral load effects. The MCE shaking and design gravity load combinations required in ASCE 7 have a low probability of occurring simultaneously. Therefore, the gravity load should instead be a realistic estimate of the expected loading on a typical day in the life of the structure. In this chapter, two gravity load cases are used. One includes an expected live loading characterizing probable live loading at the time of the Maximum Considered Earthquake shaking, and the other, no live load. The case without live load is required to be considered only for those structures where live load constitutes an appreciable amount of the total gravity loading. In those cases, structural response modes can be significantly different, depending on whether the live load is present. The dead load used in this analysis should be determined in a manner consistent with the determination of seismic mass. When used, the live load is reduced from the nominal design live load to reflect both the low probability of the full design live load occurring simultaneously throughout the building and the low probability that the design live load and Maximum Considered Earthquake shaking will occur simultaneously.

The reduced live load values, of $0.8L_0$ for live loads that exceed $100 \text{ lb} / \text{ft}^2$ ($4.79 \text{ kN} / \text{m}^2$) and $0.4L_0$ for all other live loads, were simply taken as the maximum reduction allowable in Sections 4.7.2 and 4.7.3.

Gravity loads are to be applied to the nonlinear model first and then ground shaking simulations applied. The initial application of gravity load is critical to the analysis, so member stresses and displacements caused by ground shaking are appropriately added to the initially stressed and displaced structure.

C16.3.3 P-Delta Effects.

P-delta effects should be realistically included, regardless of the value of the elastic story stability coefficient $\theta = P\Delta I_e / (Vh)$. The elastic story stability coefficient is not a reliable indicator of the importance of P-delta during large inelastic deformations. This problem is especially important for dynamic analyses with large inelastic deformations because significant ratcheting can occur. During these types of analyses, when the global stiffness starts to deteriorate and the tangent stiffness of story shear to story drift approaches zero or becomes negative, P-delta effects can cause significant ratcheting (which is a precursor to dynamic instability) of the displacement response in one direction. The full reversal of drifts is no longer observed, and the structural integrity is compromised. To ascertain the full effect of P-delta effects for a given system, a comparison of static pushover curves from a P-delta model and non-P-delta model can be compared.

When including P-delta effects, it is important to capture not only the second-order behavior associated with lateral displacements but also with global torsion about the vertical axis of the system. Additionally, the gravity load used in modeling P-delta effects must include 100% of the gravity load in the structure. For these reasons, the use of a single “leaning column,” where much of a structure’s vertical weight is lumped at a single vertical coordinate, is discouraged, and instead, the structure’s vertical load should be distributed throughout the structure in a realistic manner, either through direct modeling of the gravity system or by appropriately distributed “leaning columns.”

In some structures, in addition to considering P-delta effects associated with global structural deformation, it is also important to consider local P-delta effects associated with the local deformation of members. This is particularly important for slender elements subject to buckling.

C16.3.4 Torsion.

Inherent torsion is actual torsion caused by differences in the location of the center of mass and center of rigidity throughout the height of the structure. Accidental torsion effects per Section 12.8.4.2 are artificial effects that attempt to account for actual variations in load and material strengths during building operation that differ from modeling assumptions. Some examples of this difference would be nonuniformity of the actual mass in the building, unaccounted for openings in the diaphragm, torsional foundation input motion caused by the ground motion being out of phase at various points along the base, the lateral stiffness of the gravity framing, variation in material strength and stiffness caused by typical construction tolerances, and incidental stiffness contribution by the nonstructural elements.

When the provision for accidental torsion was first introduced, it was to address buildings that have no inherent torsion but are sensitive to torsional excitation. Common examples of this type of configuration are cruciform core or I-shaped core buildings. In reality, many things can cause such a building to exhibit some torsional response. None of the aforementioned items are typically included in the analysis model; therefore, the accidental torsion approach was introduced to ensure that the structure has some minimum level of resistance to incidental twisting under seismic excitation.

The accidental torsion also serves as an additional check to provide more confidence in the torsional stability of the structure. During the initial proportioning of the structure using linear analysis (per Section 16.1.1), accidental torsion is required to be enforced in accordance with Section 12.8.4.2. When there is no inherent torsion in the building, accidental torsion is a crucial step in the design process because this

artificial offset in the center of mass is a simple way to force a minimum level of twisting to occur in the building. The accidental torsion step (i.e., the required 5% force offsets) is also important when checking for plan irregularities in symmetric and possibly torsionally flexible buildings. Where there is already inherent torsion in the building, additional accidental torsion is not generally a crucial requirement (though still required, in accordance with Section 12.8.4.2) because the building model will naturally twist during analysis, and no additional artificial torsion is required for this twisting to occur. However, for buildings exhibiting either torsional or extreme torsional irregularities, inclusion of accidental torsion in the nonlinear analysis is required by this standard to assist in identification of potential nonlinear torsional instability.

C16.3.5 Damping.

Viscous damping can be represented by combined mass and stiffness (Rayleigh) damping. To ensure that the viscous damping does not exceed the target level in the primary response modes, the damping is typically set at the target level for two periods, one above the fundamental period and one below the highest mode frequency of significance. For very tall buildings, the second and even third modes can have significant contributions to response; in this case, the lower multiple on T_1 may need to be reduced to avoid excessive damping in these modes.

Viscous damping may alternatively be represented by modal damping, which allows for the explicit specification of the target damping in each mode.

Various studies have shown that the system damping may vary with time as the structure yields, and in some cases, damping well above the target levels can temporarily exist. Zareian and Medina (2010) provide recommendations for implementation of damping in such a way that the level of viscous damping remains relatively constant throughout the response.

The level of structural damping caused by component-level hysteresis can vary significantly based on the degree of inelastic action. Typically, hysteretic damping provides a damping contribution less than or equal to 2.5% of critical.

Damping and/or energy dissipation caused by supplemental damping and energy dissipation elements should be explicitly accounted for with component-level models and not included in the overall viscous damping term.

C16.3.6 Explicit Foundation Modeling.

The PEER TBI guidelines (Bozorgnia et al. 2009) and NIST GCR 12-917-21 (NIST 2012) both recommend inclusion of subterranean building levels in the mathematical model of the structure. The modeling of the surrounding soil has several possible levels of sophistication, two of which are depicted below in (b) and (c) of Figure C16.3-1, which are considered most practical for current practice. For an MCE_R -level assessment, which is the basis for the Chapter 16 RHA procedure, the rigid bathtub model is preferred by PEER TBI (Bozorgnia et al. 2009) and NIST (2012) (Figure C16.3-1c). This model includes soil springs and dashpots, and identical horizontal ground motions are input at each level of the basement. Such a modeling approach, where the soil is modeled in the form of springs and/or dashpots (or similar methods) placed around the foundation, is encouraged but is not required. When spring and dashpot elements are included in the structural model, horizontal input ground motions are applied to the ends of the horizontal soil elements rather than being applied to the foundation directly. A simpler but less accurate model is to exclude the soil springs and dashpots from the numerical model and apply the horizontal ground motions at the bottom level of the basement (Figure C16.3-1b), which is fixed at the base. Either the fixed-base (Figure C16.3-1b) or bathtub (Figure C16.3-1c) approaches are allowed, but the bathtub approach is encouraged because it is more accurate.

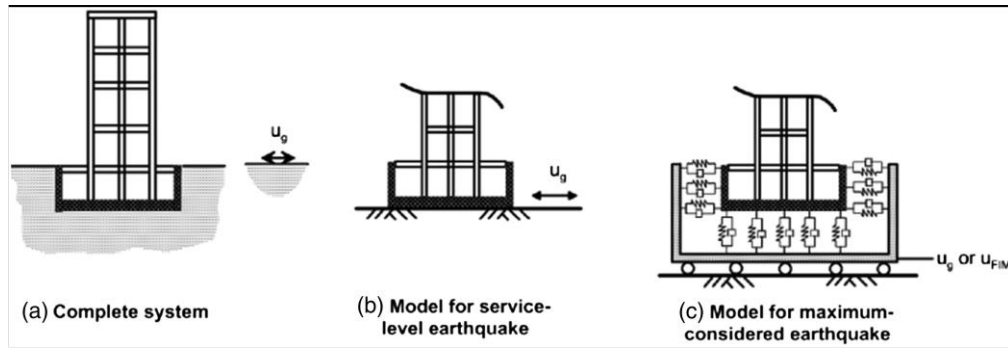

FIGURE C16.3-1 Illustration of the Method of Inputting Ground Motions into the Base of the Structural Model

Source: NIST 2011.

For the input motions, the PEER TBI (Bozorgnia et al. 2009) guidelines allow the use of either the free-field motion, which is the motion defined in Section 16.2.2, or a foundation input motion modified for kinematic interaction effects. Guidelines for modeling kinematic interaction are contained in NIST (2012).

More sophisticated procedures for soil–structure interaction modeling, including the effects of multisupport excitation, can also be applied in RHA. Such analyses should follow the guidelines presented in NIST (2012).

Approximate procedures for the evaluation of foundation springs are provided in Chapter 19 of this standard.

C16.4.1 Global Acceptance Criteria

C16.4.1.1 Unacceptable Response.

This section summarizes the criteria for determining unacceptable response and how the criteria were developed. It must be made clear that these unacceptable response acceptance criteria are not the primary acceptance criteria that ensure adequate collapse safety of the building; the primary acceptance criteria are the story drift criteria and the element-level criteria discussed later in Section C16.4. The unacceptable response acceptance criteria were developed to be a secondary protection to supplement the primary criteria. Unacceptable responses result in instabilities and loss of gravity load support. Consequently, if it can be shown that after a deformation controlled element reaches its (collapse prevention) limit, the model is able to redistribute demands to other elements, this would not constitute unacceptable response. The acceptance criteria were intentionally structured in this manner because there is high variability in unacceptable response (as described in this section) and the other primary acceptance criteria are much more stable and reliable (because they are based on mean values of 11 motions rather than the extreme response of 11 motions).

When performing nonlinear analysis for a limited suite of ground motions, the observance of a single unacceptable response (or, conversely, the observance of no unacceptable responses) is statistically insignificant. That is, it is reasonably probable that no collapses will be observed in a small suite of analyses, even if the structure has a greater than 10% chance of collapse at MCE_R shaking levels. It is also possible that a structure with less than a 10% chance of collapse at MCE_R shaking levels will still produce an unacceptable response for one ground motion in a small suite. In order for statistics on the number of unacceptable responses in a suite of analyses to produce meaningful indication of collapse probability, a very large suite of analyses must be performed. Furthermore, the observance or nonobservance of an unacceptable response depends heavily on how the ground motions were selected and scaled (or spectrally matched) to meet the target spectrum.

Since the observance or nonobservance of an unacceptable response is not statistically meaningful, the standard does not rely heavily on the prohibition of unacceptable responses in the attempt to “prove” adequate collapse safety. The many other acceptance criteria of Section 16.4 are relied upon to implicitly ensure adequate collapse safety of the building. If one desired to expand the unacceptable response acceptance criteria to provide true meaningful collapse safety information about the building, a more complex statistical inference approach would need to be used. This is discussed further below.

The statistical insignificance of unacceptable response in a small suite of analyses leaves a large open question about how to interpret the meaning of such responses when they occur. Even though occurrence of a single unacceptable response is statistically meaningless, the occurrence of many unacceptable responses (e.g., 5 of 11) does indicate that the collapse probability is significantly in excess of 10%. Additionally, a conscientious structural designer is concerned about such occurrence, and the occurrences of unacceptable responses may provide the designer with some insight into possible vulnerabilities in the structural design.

Some engineers presume that the acceptance criteria related to *average* response effectively disallow any unacceptable responses (because you cannot average in an infinite response), while others presume that *average* can also be interpreted as *median*, which could allow almost half of the ground motions to cause unacceptable response.

The statistics presented below are provided to help better interpret the meaning of observance of a collapse or other type of unacceptable response in a suite of analyses. These simple statistics are based on predicting the occurrence of collapse (or other unacceptable response) using a binomial distribution, based on the following assumptions:

- The building’s collapse probability is exactly 10% at the MCE_R level.
- Collapse probability is lognormally distributed and has a dispersion (lognormal standard deviation) of 0.6. This value includes all sources of uncertainty and variability (e.g., record-to-record variability, modeling uncertainty). The value of 0.6 is the same value used in creating the risk-consistent hazard maps for ASCE 7-10 (FEMA 2009a) and is consistent with the values used in FEMA P-695 (FEMA 2009b).
- The record-to-record variability ranges from 0.25 to 0.40. This is the variability in the collapse capacity that would be expected from the analytical model. This value is highly dependent on the details of the ground motion selection and scaling; values of 0.35 to 0.45 are expected for motions that are not fit tightly to the target spectrum, and values of 0.2 to 0.3 are expected for spectrally matched motions (FEMA 2009b).

Figure C16.4-1 shows collapse fragility curves for a hypothetical building that has a 10% collapse probability conditioned on MCE_R motion ($P[C|MCE_R]=10\%$) with an assumed record-to-record collapse uncertainty of 0.40 and a total collapse uncertainty of 0.60. The Figure shows that the median collapse capacity must be a factor of 2.16 above the MCE_R ground motion level, that the probability of collapse is 10% at the MCE_R when the full variability is included (as required), but that the probability of collapse is only 2.7% at the MCE_R when only the record-to-record variability is included. This 2.7% collapse probability is what would be expected from the structural model that is used in the RHA assessment procedure.

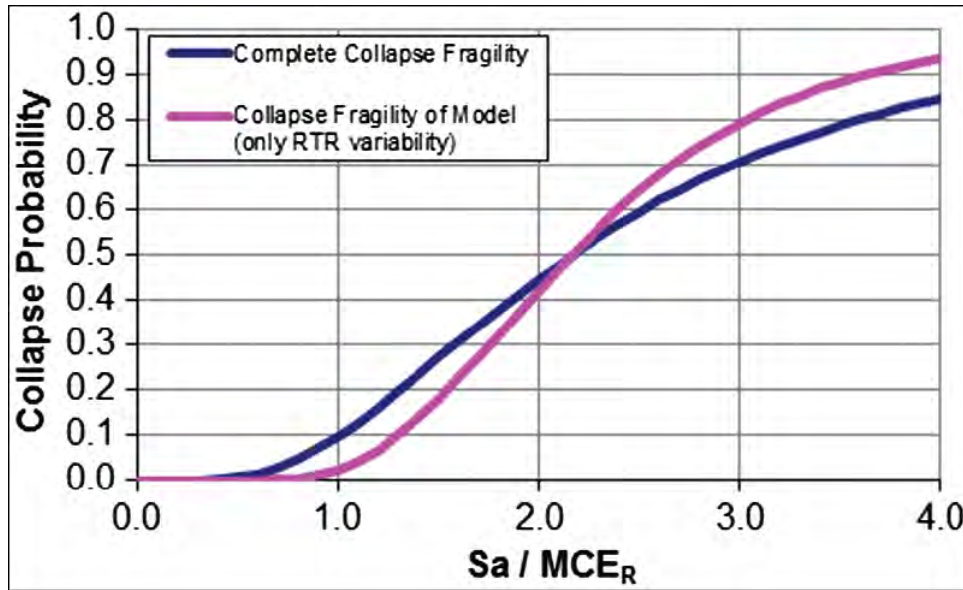

FIGURE C16.4-1 Collapse Fragilities for a Building with $P[C | MCE_R] = 10\%$ and $\beta_{COL,RTR} = 0.40$

Table C16.4-1 shows the probability of observing n collapses in a suite of 11 ground motions for a structure that has different values of $P[C | MCE_R]$.

Table C16.4-1 Likelihood of Observing Collapses in 11 Analyses, Given Various MCE_R Collapse Probabilities and a Record-to-Record Uncertainty of 0.4

Number of Collapses	Likelihood for Various $P[C MCE_R]$ Values				
	0.05	0.10	0.15	0.20	0.30
0 of 11	0.93	0.74	0.51	0.30	0.07
1 of 11	0.07	0.23	0.36	0.38	0.21
2 of 11	0	0.03	0.11	0.22	0.29
3 of 11	0	0	0.02	0.08	0.24
4 of 11	0	0	0	0.02	0.13
5 of 11	0	0	0	0	0.05

Table C16.4-1 shows that for a building meeting the $P[C | MCE_R] = 10\%$ performance goal, there is a 74% chance of observing no collapses, a 23% chance of observing one collapse, a 3% chance of observing two collapses, and virtually no chance of observing more than two collapses. In comparison, for a building with $P[C | MCE_R] = 20\%$, there is a 30% chance of observing no collapses, a 38% chance of observing one collapse, a 22% chance of observing two collapses, and a 10% chance of observing more than two collapses.

This table illustrates that

- Even if no collapses are observed in a set of 11 records, this does not, in any way, prove that the $P[C | MCE_R] = 10\%$ performance goal has been met. For example, even for a building with $P[C | MCE_R] = 20\%$, there is still a 30% chance that no collapses will be observed in the analysis. Therefore, the other noncollapse acceptance criteria (e.g., criteria for drifts and element demands) must be relied upon to enforce the 10% collapse probability goal.
- If the $P[C | MCE_R] = 10\%$ performance goal is met, it is highly unlikely (only a 3% chance) that two collapses will be observed in the set of 11 records. Therefore, an acceptance criterion that prohibits two collapses is reasonable.

The collapse likelihoods show in Table C16.4-1 are based on a relatively large record-to-record variability value of 0.40. Table C16.4-2 illustrates similar statistics for the case when the record-to-record variability is suppressed in ground motion selection and scaling, such as occurs with spectral matching. This table shows that, for a building meeting the $P[C | MCE_R] = 10\%$ performance goal and with record-to-record variability taken as 0.25, the likelihood of observing a collapse response is very low. This is why no unacceptable responses are permitted in the suite of analyses when spectral matching is used.

Table C16.4-2 Likelihood of Observing Collapses in 11 Analyses, Given Various MCE_R Collapse Probabilities and a Record-to-Record Uncertainty of 0.25

Number of Collapses	Likelihood for Various $P[C MCE_R]$ Values				
	0.05	0.10	0.15	0.20	0.30
0 of 11	1.00	0.99	0.93	0.79	0.30
1 of 11	0	0.01	0.07	0.19	0.38
2 of 11	0	0	0	0.02	0.22
3 of 11	0	0	0	0	0.08
4 of 11	0	0	0	0	0.02
5 of 11	0	0	0	0	0

For Risk Category I and II structures, if more than 11 ground motions are used for analysis, then additional unacceptable responses may be permissible. Two unacceptable responses would be permissible if 20 or more motions are used, and three unacceptable responses are permissible when 30 or more motions are used. For Risk Category III and IV structures, the collapse probability goals are 6% and 3%, respectively, at the MCE_R level. When the above computations are redone using these lower collapse probability targets, this shows that the acceptance criteria should require that no motions of the 11 produce an unacceptable response for these categories.

Typically, mean building response values (story drifts, element deformations, and forces) are used in acceptance evaluations, where the “mean” is the simple statistical average for the response parameter of interest. When an unacceptable response occurs, it is not possible to compute a mean value of the building

response values because one of the 11 response quantities is undefined. In this case, rather than the mean, the standard requires use of the counted median response multiplied by 1.2 but not less than the mean response from the remaining motions.

To compute the median value, the unacceptable response is assumed as larger than the other responses and then, assuming that 11 analyses were performed, the counted median value is taken to be the 6th largest value from the set of 11 responses. The 1.2 factor is based on a reasonable ratio of mean to median values for a lognormal distribution ($\beta = 0.4$ results in mean / median = 1.08, $\beta = 0.5$ results in mean / median = 1.13, $\beta = 0.6$ results in mean / median = 1.20, and $\beta = 0.7$ results in mean / median = 1.28).

The requirement to also check the mean of the remaining 10 response results is simply an added safeguard to ensure that the $1.2 \times$ median value does not underpredict the mean response values that should be used when checking the acceptance criteria.

Although currently the purpose of this acceptance criterion is not to quantify the structure's collapse probability under MCE_R ground motions, the acceptance criterion can be recast to do so in future provisions. The collapse probability can be inferred from analysis results and compared to the target value (e.g., 10% for structures in Risk Category I or II). In this alternate light, existing statistical inference theory can be used to determine the number of acceptable responses, and the number of ground motions required to conclude that the proposed design may have an acceptable collapse probability.

As was done in the previous section, analysis results can be thought of as following a binomial distribution. Based on this distribution, one could use the observed counts of collapsed and noncollapsed responses (indicated by unacceptable and acceptable responses) to estimate the collapse probability of the proposed design in a manner that accounts for the uncertainty in the estimated collapse probability. This uncertainty depends on the total number of ground motions. If few ground motions are used, there is a large uncertainty in the collapse probability. If many ground motions are used, there is a small uncertainty. For example, compare a set of 11 ground motions with 1 unacceptable response to a set of 110 ground motions with 10 unacceptable responses. Both sets have a most likely unacceptable response probability of 9.1%. The design with 1 unacceptable and 10 acceptable responses has only a 34% chance that its unacceptable response probability is 10% or less. The design with 10 unacceptable and 100 acceptable responses has a 56% chance that its unacceptable response probability is 10% or less.

In the current acceptance criterion, the choice to require 11 ground motions follows from the need to have confidence in the average values of the resulting element-level and story-level responses (Section C16.2.3.1). These element-level and story-level responses are then used to *implicitly* demonstrate adequate collapse safety. If future provisions seek to *explicitly* ensure that the proposed design has an acceptable collapse probability, then this unacceptable response acceptance criterion should be revised using statistical inference theory to establish the number of required ground motions and the maximum number of unacceptable responses, as well as the element- and story-level response limits.

C16.4.1.2 Story Drift.

The limit on mean story drift was developed to be consistent with the linear design procedures of this standard. To this end, the basic Table 12.12-1 story drift limits are the following:

- Increased by a factor of 1.5, to reflect the analysis being completed at the MCE_R ground motion level rather than at two-thirds of the MCE_R level, and
- Increased by another factor of 1.25, to reflect an average ratio of R/C_d .

These two above increases are the basis for the requirement that the mean story drift be limited to 1.9 (which was rounded to 2.0) of the standard Table 12.12-1 limits.

The masonry-specific drift limits of Table 12.12-1 are not enforced in this section because the component-level acceptance criteria of Section 16.4.2 are expected to result in equivalent performance (i.e., a masonry building designed in accordance with Chapter 16 is expected to have similar performance to a masonry building designed using linear analysis methods and the more stringent drift limits of Table 12.12-1).

The standard does not require checks on residual drift. Residual drifts are an indicator of incipient dynamic instability, and a prudent engineer checks for this instability. Limiting residual drifts is an important consideration for postearthquake operability and for limiting financial losses, but such performance goals are not included in the scope of the ASCE 7 standard. For Risk Category I and II buildings, the ASCE 7 standard is primarily meant to ensure the protection of life safety. Additionally, residual drifts can be extremely difficult to predict reliably with available structural analysis tools.

C16.4.2 Element-Level Acceptance Criteria.

The element-level acceptance criteria require classification of each element action as either force-controlled or deformation-controlled, similar to the procedures of ASCE 41. Note that this is done for each *element action*, rather than for each *element*. For example, for a single column element, the flexural behavior may be classified as a deformation-controlled action, whereas the axial behavior may be classified as a force-controlled action.

Deformation-controlled actions are those that have reliable inelastic deformation capacity. Force-controlled actions pertain to brittle modes where inelastic deformation capacity cannot be ensured. Based on how the acceptance criteria are structured, any element action that is modeled elastically must be classified as being force-controlled.

Some examples of force-controlled actions are

- Shear in reinforced concrete (other than diagonally reinforced coupling beams).
- Axial compression in columns.
- Punching shear in slab-column joints without shear reinforcing.
- Connections that are not explicitly designed for the strength of the connected component, such as some braces in braced frames.
- Displacement of elements resting on a supporting element without rigid connection (such as slide bearings).
- Axial forces in diaphragm collectors.

Some examples of deformation-controlled actions are

- Shear in diagonally reinforced coupling beams.
- Flexure in reinforced concrete columns and walls.
- Axial yielding in buckling restrained braces.
- Flexure in special moment frames.

Section 16.4.2 further requires categorization of component actions as critical, ordinary, or noncritical based on the consequence of their exceeding strength or deformation limits. Because of the differences in consequence, the acceptance criteria are developed differently for each of the above classifications of component actions. An element's criticality is judged based on the extent of collapse that may occur, given the element's failure, and also a judgment as to whether the effect of the element's failure on seismic resistance is substantive. An element's failure could be judged to have substantial effect on the structure's seismic resistance if analysis of a model of the building without the element present predicts unacceptable performance, while analysis with the element present does not.

Limits placed on response quantities are correlated to building performance and structural reliability. In order for compliance with these limits to meaningfully characterize overall performance and reliability, grouping of certain component actions for design purposes may be appropriate. For example, while

symmetrical design forces may be obtained for symmetrical structures using equivalent lateral force and modal response spectrum analysis procedures, there is no guarantee that component actions in response history analysis of symmetrical models will be the same—or even similar—for identical components arranged symmetrically. Engineering judgment should be applied to the design to maintain symmetry by using the greater demands (that is, the demands on the more heavily loaded component determined using the appropriate factor on its mean demand) for the design of both components. For this purpose, using the mean demands of the pair of components would not be appropriate because this method would reduce the demand used for design of the more heavily loaded component.

Though this point is perhaps trivial in the case of true symmetry, it is also a concern in nonsymmetrical structures. For these buildings, it may be appropriate to group structural components that are highly similar either in geometric placement or purpose. The demands determined using the suite mean (the mean response over all ground motions within a suite) may be very different for individual components within this grouping. This is a result both of the averaging process and the limited explicit consideration of ground motion to structure orientation in the provisions. Although the analysis may indicate that only a portion of the grouped components do not meet the provisions, the engineer ought to consider whether such nonconformance should also suggest redesign in other similar elements. Thus response history analysis places a higher burden on the judgment of the engineer to determine the appropriate methods for extracting meaningful response quantities for design purposes.

C16.4.2.1 Force-Controlled Actions.

The acceptance criteria for force-controlled actions follow the framework established by the PEER TBI guidelines (Bozorgnia et al. 2009), shown in Eq. (C16.4-1):

$$\lambda F_u \leq \phi F_{n,e} \quad (\text{C16.4-1})$$

where λ is a calibration parameter, F_u is the mean demand for the response parameter of interest, ϕ is the strength reduction factor from a material standard, and $F_{n,e}$ is the nominal strength computed from a material standard considering expected material properties.

To determine appropriate values of λ , we begin with the collapse probability goals of Table 1.3-2 (for Risk Categories I and II) for MCE_R motions. These collapse probability goals include a 10% chance of a total or partial structural collapse and a 25% chance of a failure that could result in endangerment of individual lives. For the assessment of collapse, we then make the somewhat conservative assumption that the failure of a single critical force-controlled component would result in a total or partial structural collapse of the building.

Focusing first on the goal of a 10% chance of a total or partial structural collapse, we assume that the component force demand and component capacity both follow a lognormal distribution and that the estimate of $F_{n,e}$ represents the true expected strength of the component. We then calibrate the λ value required to achieve the 10% collapse probability goal. This value is depicted in Figure C16.4-2, which shows the lognormal distributions of component capacity and component demand.

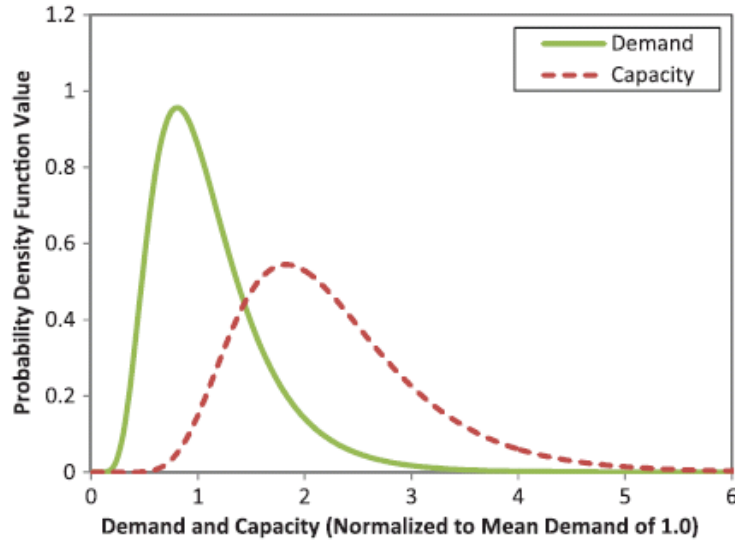

FIGURE C16.4-2 Illustration of Component Capacity and Demand Lognormal Distributions (Normalized to a Mean Capacity of 1.0); the Mean Component Capacity Is Calibrated to Achieve $P[C | MCE_R] = 10\%$

The calibration process is highly dependent on the uncertainties in component demand and capacity. Table C16.4-3a shows typical uncertainties in force *demand* for analyses at the MCE_R ground motion level for both the general case and the case where the response parameter is limited by a well-defined yield mechanism. Table C16.4-3b shows typical uncertainty values for the component *capacity*. The values are based on reference materials, as well as the collective experience and professional judgment of the development team.

Table C16.4-3a Assumed Variability and Uncertainty Values for Component Force Demand

Demand Dispersion (β_D)		Variabilities and Uncertainties in the Force Demand
General	Well-Defined Mechanism	
0.40	0.20	Record-to-record variability (for MCE_R ground motions)
0.20	0.20	Uncertainty from estimating force demands using structural model
0.13	0.06	Variability from estimating force demands from mean of only 11 ground motions
0.46	0.29	$\beta_{D-Total}$

Table C16.4-3b Assumed Variability and Uncertainty Values for Component Force Capacity

Capacity Dispersion (β_C)		Variabilities and Uncertainties in the Final As-Built Capacity of the Component
General	Well-Defined Mechanism	
0.30	0.30	Typical variability in strength equation for $F_{n,e}$ (from available data)
0.10	0.10	Typical uncertainty in strength equation for $F_{n,e}$ (extrapolation beyond available data)
0.20	0.20	Uncertainty in as-built strength because of construction quality and possible errors
0.37	0.37	$\beta_{C\text{-Total}}$

In the calibration process, the λ and φ values both directly affect the required component strength. Therefore, the calibration is completed to determine the required value of λ/φ needed to fulfill the 10% collapse safety objective. This calibration is done by assuming a value of λ/φ , convolving the lognormal distributions of demand and capacity and iteratively determining the capacity required to meet the 10% collapse safety objective by adjusting λ/φ .

Table C16.4-4 reports the final λ/φ values that come from such integration.

Table C16.4-4 Required Ratios of λ/φ to Achieve the 10% Collapse Probability Objective

Dispersion	Required Ratios of λ/φ
General	2.1
Well-Defined Mechanism	1.9

It should be clearly stated that this approach of calibrating the λ/φ ratio means that the final acceptance criterion is independent of the φ value specified by a material standard. If it is desirable for the acceptance criteria to be partially dependent on the value of φ , then the uncertainty factors of Table C16.4-3b would need to be made dependent on the φ value in some manner.

Since the Table C16.4-4 values are similar, for simplicity the acceptance criterion is based on $\lambda/\varphi = 2.0$ for all cases, and a separate case for the existence of a well-defined mechanism is not included. Additionally, the strength term is defined slightly differently. For Risk Categories III and IV, this full calculation was redone using the lower collapse probability goals of 6% and 3%, respectively, and it was found that scaling the force demands by I_e sufficiently achieves these lower collapse probability goals.

This statistical calculation was then repeated for the goal of 25% chance of a failure that could result in endangerment of individual lives. This resulted in a required ratio of 1.5 for such force-controlled failure modes; deemed as “ordinary.”

Force-controlled actions are deemed noncritical if the failure does not result in structural collapse or any meaningful endangerment to individual lives; this occurs in situations where gravity forces can reliably redistribute to an alternate load path and no failure will ensue. For noncritical force-controlled components, the acceptance criteria allow the use of $\lambda = 1.0$.

Where an industry standard does not define expected strength, expected (or mean) strength, F_e , is computed as follows. First, a standard strength-prediction equation is used from a material standard, using a strength reduction factor, ϕ , of 1.0; the expected material properties are also used in place of nominal material properties. In some cases, this estimate of strength ($F_{n,e}$) may still be conservative in comparison with the mean expected strength shown by experimental tests (F_e) caused by inherent conservatism in the strength equations adopted by the materials standards. If such conservatism exists, the $F_{n,e}$ value may be multiplied by a “component reserve strength factor” greater than 1.0 to produce the estimate of the mean expected strength (F_e). This process is illustrated in Figure C16.4-3, which shows the $F_e / F_{n,e}$ ratios for the shear strengths from test data of reinforced concrete shear walls (Wallace et al. 2013). This Figure shows that the ratio of $F_e / F_{n,e}$ depends on the flexural ductility of the shear wall, demonstrating that $F_e = 1.0 F_{n,e}$ is appropriate for the shear strength in the zone of high flexural damage and $F_e = 1.5 F_{n,e}$ may be appropriate in zones with no flexural damage.

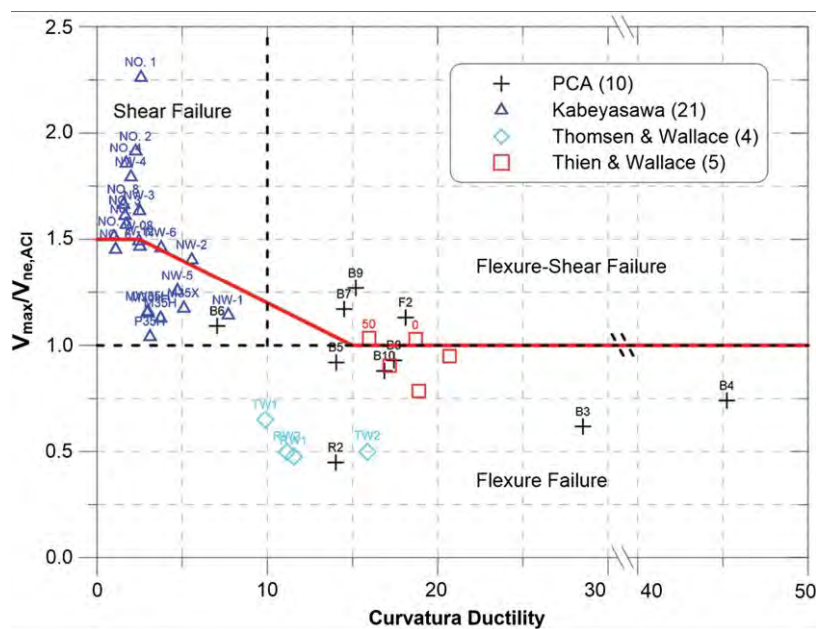

FIGURE C16.4-3 Expected Shear Strengths (in Terms of $F_e / F_{n,e}$) for Reinforced Concrete Shear Walls When Subjected to Various Levels of Flexural Ductility

Source: Courtesy of John Wallace.

For purposes of comparison, Eq. (C16.4-1) is comparable to the PEER TBI acceptance criteria (Bozorgnia et al. 2009) for the case that $\phi = 0.75$ and $F_e = 1.0 F_{n,e}$.

The exception allows for use of the capacity design philosophy for force-controlled components that are “protected” by inelastic fuses, such that the force delivered to the force-controlled component is limited by the strength of the inelastic fuse.

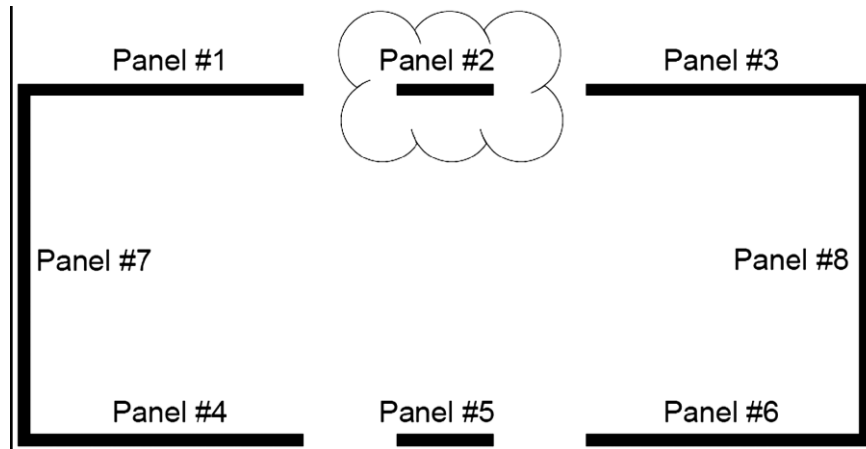

FIGURE C16.4-5 Plan View of Sample Building Showing Components of a Reinforced Concrete Core Shear Wall

The following are some examples of force-controlled actions that are deemed to be critical actions:

- Steel Moment Frames (SMF):
 - Axial compression forces in columns caused by combined gravity and overturning forces
 - Combined axial force, bending moments, and shear in column splices
 - Tension in column base connections (unless modeled inelastically, in which case it would be a deformation-controlled component)
- Steel Braced Frames (BRBF - Buckling Restrained Braced Frame, SCBF - Special Concentrically Braced Frames):
 - Axial compression forces in columns caused by combined gravity and overturning forces
 - Combined axial force, bending moments, and shear in column splices
 - Tension in brace and beam connections
 - Column base connections (unless modeled inelastically)
- Concrete Moment Frames:
 - Axial compression forces in columns caused by combined gravity and overturning forces
 - Shear force in columns and beams
- Concrete or Masonry Shear Walls:
 - Shear in concrete shear wall, in cases when there is limited ability for the shear force to transfer to adjacent wall panels. For cases of isolated shear walls (i.e., wall #1 in Figure C16.4-4), the shear force in this isolated wall is deemed as a critical action. In contrast, the shear force in a one-wall pier that is in a group of wall piers (e.g., panel #2 of Figure C16.4-5) need not be deemed a critical action (especially when determining whether an analysis is deemed to represent an unacceptable response). For this case of a group of wall piers, it may be appropriate to consider the sum of the wall shears to be the critical action (e.g., the sum of wall shears in panels #1, #2, and #3 of Fig C16.4-5).
 - Axial (plus flexural) compression in concrete shear wall (for most cases)
 - Axial compression in outrigger columns
 - Axial (plus flexural) tension in outrigger column splices
- Other Types of Components:
 - Shear forces in piles and pile cap connections (unless modeled inelastically)
 - Shear forces in shallow foundations (unless modeled inelastically)

- Punching shear in slabs without shear reinforcing (unless modeled inelastically)
- Diaphragms that transfer a substantial amount of force (from more than one story)
- Elements supporting discontinuous frames and walls

The following are some examples of force-controlled actions that are deemed to be ordinary actions:

- Steel Moment Frames (SMF):
 - Shear force in beams and columns
 - Column base connections (unless modeled inelastically)
 - Welded or bolted joints (as distinct from the inelastic action of the overall connection) between moment frame beams and columns
- Steel Braced Frames (BRBF, SCBF):
 - Axial tension forces in columns caused by overturning forces (unless modeled inelastically)
- Concrete Moment Frames:
 - Splices in longitudinal beam and column reinforcement
- Concrete or Masonry Shear Walls:
 - An ordinary classification would only apply in special cases where failure would not cause widespread collapse and would cause minimal reduction in the building seismic resistance.
- Other Types of Components:
 - Axial forces in diaphragm collectors (unless modeled inelastically)
 - Shear and chord forces in diaphragms (unless modeled inelastically)
 - Pile axial forces

The following are some examples of force-controlled actions that could be deemed noncritical actions:

- Any component where the failure would not result in either collapse or substantive loss of the seismic resistance of the structure.

C16.4.2.2 Deformation-Controlled Actions.

While substantive data exist to indicate the capacity of force-controlled actions, there are relatively few laboratory data to indicate the deformation at which a deformation-controlled element action reaches a level where loss of vertical load-carrying capacity occurs. There are a number of reasons for this, including the following: (1) the deformation at which such loss occurs can be very large and beyond the practical testing capability of typical laboratory equipment; (2) many researchers have tested such components with the aim of quantifying useful capacity for elements of a seismic force-resisting system and have terminated testing after substantial degradation in strength has occurred, even though actual failure has not yet been experienced; and (3) testing of gravity-load-bearing elements to failure can be dangerous and destructive of test equipment. Therefore, lacking a comprehensive database on the reliable collapse capacity of different deformation-controlled element actions, the standard defaults to acceptance criteria contained in ASCE 41. However, the standard does present alternative criteria, which directly use the expected deformation at which loss of vertical load-carrying capacity occurs, in the recognition that use of such values is more consistent with the collapse goals of Section C1.3.1 and also in the hopes that data on the deformation capacity of elements will eventually be available for use.

To determine appropriate inelastic deformation limits for this alternative procedure, a process similar to that used for force-controlled actions is used. Table C16.4-5a shows the assumed uncertainties in deformation demand for structural analyses for MCE_R ground motions. Table C16.4-5b similarly shows assumed uncertainties in the component deformation capacity at the point that loss in vertical load-carrying capacity occurs. These β_C values are larger than the comparable values for force-controlled components because the uncertainty is quite large when trying to quantify the deformation at which loss of vertical load-carrying capacity occurs.

Table C16.4-5a Assumed Variability and Uncertainty Values for Component Deformation Demand

Demand Dispersion (β_D)	Variabilities and Uncertainties in the Deformation Demand
0.40	Record-to-record variability (for MCE_R ground motions)
0.20	Uncertainty from estimating deformation demands using structural model
0.13	Variability from estimating deformation demands from mean of only 11 ground motions
0.46	$\beta_{D\text{-Total}}$

Table C16.4-5b Assumed Variability and Uncertainty Values for Component Deformation Capacity

Capacity Dispersion (β_C)	Variabilities and Uncertainties in the Final As-Built Deformation Capacity of the Component
0.60	Typical variability in prediction equation for deformation capacity (from available data)
0.20	Typical uncertainty in prediction equation for deformation capacity (extrapolation beyond data)
0.20	Uncertainty in as-built deformation capacity because of construction quality and errors
0.66	$\beta_{C\text{-Total}}$

The results of integration show that the mean deformation capacity must be a factor of 3.2 larger than the mean deformation demand in order to meet the 10% collapse safety objective (for total or partial structural collapse) for MCE_R ground motions. Using the inverse of this value leads to a requirement that the mean deformation demand be limited to less than 0.3 of the mean deformation capacity.

This 0.3 limit is quite conservative and assumes that immediate collapse results when the deformation capacity is exceeded in a single component. Such immediate collapse may occur in some uncommon cases where no alternative load path exists; however, in most cases, there is at least one alternative load path and the gravity loads will redistribute and delay the occurrence of vertical collapse. Note that the use of a 0.3 ratio in the acceptance criterion assumes that there is a 100% probability of building collapse when the deformation capacity is exceeded in a single component; the use of a 0.5 ratio instead implies a 40% probability of building collapse when the deformation capacity is exceeded in a single component. These are the acceptance criteria used for critical deformation-controlled actions.

This statistical calculation was then redone for the goal of a 25% chance of a failure that would result in endangerment of individual lives. The results of integration show that the mean deformation capacity must be a factor of 2.0 larger than the mean deformation demand in order to meet the 25% goal for MCE_R ground

motions; using the inverse of this value, this leads to a requirement that the mean deformation demand be limited to less than 0.5 of the mean deformation capacity.

For noncritical deformation-controlled actions, by definition, the failure of such a component would not result in any collapse and also would not result in substantive loss in the seismic strength of the structure. Accordingly, for such a case, the inelastic deformation is not limited by the Section 16.4.2.2 acceptance criterion (because there is no meaningful consequence of failure for such component), but the inelastic deformation of such component is still limited by the unacceptable response criterion of Section 16.4.1.1 (i.e., the component must be adequately modeled up to the deformation levels that the component experiences in the structural simulation).

The following are some examples of deformation-controlled actions that are deemed to be critical actions:

- Steel Moment Frames (SMF)
 - Hinge rotations in beams and columns leading to significant strength/stiffness degradation
 - Deformations of nonductile gravity beam-to-column connections
- Steel Braced Frames (BRBF, SCBF)
 - Axial deformations (tension/compression) in braces
 - Hinge rotations in beams and columns leading to significant strength/stiffness degradation
 - Deformations of nonductile gravity beam-to-column connections
- Concrete Moment Frames:
 - Hinge rotations in beams and columns leading to significant strength/stiffness degradation
 - Deformations of nonductile slab–column connections in reinforced concrete gravity systems
- Concrete Shear Walls:
 - Tensile strains in longitudinal wall reinforcement
 - Compression strains in longitudinal wall reinforcement and concrete
 - Flexural hinging or shear yielding of coupling beams
 - Deformations of nonductile slab–column or slab–wall connections in reinforced concrete gravity systems

Other Types of Components:

- Soil uplift and bearing deformations in shallow foundations (when modeled inelastically)
- Tensile pullout deformations or compression bearing deformations of pile foundations (when modeled inelastically)

The following are some examples of deformation-controlled actions that are deemed to be ordinary actions:

- Steel Moment Frames (SMF):
 - Deformations of ductile gravity beam-to-column connections
- Steel Braced Frames (BRBF, SCBF, or nonconforming braced frames):
 - Deformations of ductile gravity beam-to-column connections
- Concrete Moment Frames:
 - Deformations of ductile slab–column connections in reinforced concrete gravity systems
- Concrete Shear Walls:
 - Deformations of ductile slab–column or slab–wall connections in reinforced concrete gravity systems

The following are some examples of deformation-controlled actions that could be deemed noncritical actions:

- Deformations in a coupling beam in a shear wall system, in the case that the failure of the coupling beam neither results in any collapse nor substantive loss to seismic resistance.

C16.4.2.3 Elements of the Gravity Force-Resisting System.

The basic deformation-compatibility requirement of ASCE 7-10, Section 12.12.5 is imposed for gravity-system components, which are not part of the established seismic force-resisting system, using the deformation demands predicted from response history analysis under MCE_R -level ground motions, as opposed to evaluation under linear analysis.

If an analyst wanted to further investigate the performance of the gravity system (which is not required), the most direct and complete approach (but also the most time-consuming) would be to directly model the gravity system components as part of the structural model and then impose the same acceptance criteria used for the components of the seismic force-resisting system. An alternative approach (which is more common) would be to model the gravity system in a simplified manner and verify that the earthquake-imposed force demands do not control over the other load combinations and/or to verify that the mean gravity system deformations do not exceed the deformation limits for deformation-controlled components.

REFERENCES

- Al Atik, L., and Abrahamson, N. (2010). “An improved method for nonstationary spectral matching.” *Earthq. Spectra* 26(3), 601–617.
- Ancheta, T. D., Darragh, R. B., Stewart, J. P., Seyhan, E., Silva, W. J., Chious, B. S. J., et al. (2012). *PEER NGA-West 2 database*. Pacific Earthquake Engineering Research Center, Berkeley, CA.
- Baker, J. W. (2011). “Conditional mean spectrum: Tool for ground motion selection.” *J. Struct. Eng.*, 137(3), 322–331. [http://dx.doi.org/10.1061/\(ASCE\)ST.1943-541X.0000215](http://dx.doi.org/10.1061/(ASCE)ST.1943-541X.0000215).
- Baker, J. W., and Cornell, C. A. (2006). “Correlation of response spectral values for multi-component ground motions.” *Bull. Seismol. Soc. Am.* 96(1), 215–227.
- Bommer, J. J., Scott, S. G., and Sarma, S. K. (2000). “Hazard-consistent earthquake scenarios.” *Soil Dyn. Earthq. Eng.* 19(4), 219–231.
- Bozorgnia, Y., Crouse, C. B., Hamburger, R. O., Klemencic, R., Krawinkler, H., Malley, J. O., et al. (2009). *Guidelines for performance-based seismic design of tall buildings*, Pacific Earthquake Engineering Research Center, Berkeley, CA.
- Federal Emergency Management Agency (FEMA). (2009a). “NEHRP recommended provisions for seismic regulation for buildings and other structures,” *FEMA P-753*, FEMA, Washington, DC.
- FEMA. (2009b). “Quantification of building seismic performance factors,” *FEMA P-695*, FEMA, Washington, DC.
- Grant, D. N., and Diaferia, R. (2012). “Assessing adequacy of spectrum-matched ground motions for response history analysis,” *Earthq. Eng. Struct. Dyn.* 42(9), 1265–1280. <http://dx.doi.org/10.1002/eqe.2270>.
- Haroun, M. A., and Housner, G. W. (1981). “Seismic design of liquid storage tanks.” *J. Techn. Coun.* . ASCE, New York 107(1), 191–207.
- Housner, G. W. (1963). “The dynamic behavior of water tanks.” *Bull. Seismol. Soc. Am.* 53(2), 381–387.
- Huang, Y. N., Whittaker, A. S., and Luco, N. (2008). “Maximum spectral demands in the near fault region,” *Earthq. Spectra*, 24, 319–341.
- Jacobsen, L. S. (1949). “Impulsive hydrodynamics of fluid inside a cylindrical tank and of fluid surrounding a cylindrical pier.” *Bull. Seismol. Soc. Am.* 39(3), 189–203.

- Luco, N., and Bazzurro, P. (2007). “Does amplitude scaling of ground motion records result in biased nonlinear structural drift responses?” *Earthq. Eng. Struct. Dyn.* 36, 1813–1835.
- Naeim, F., and Lew, M. (1995). “On the use of design spectrum compatible time histories.” *Earthq. Spectra* 11(1), 111–127.
- National Institute of Standards and Technology (NIST). (2011). “Selecting and scaling earthquake ground motions for performing response-history analyses.” *GCR 11-917-15*. NEHRP Consultants Joint Venture, NIST, Gaithersburg, MD.
- NIST. (2012). “Soil-structure interaction for building structures,” *GCR 12-917-21*. NEHRP Consultants Joint Venture, NIST, Gaithersburg, MD.
- NIST. (2010). “Nonlinear structural analysis for seismic design.” *NIST GCR 10-917-5*, NIST, Gaithersburg, MD.
- NIST (National Institute of Standards, and Technology). (2011). “Selecting and scaling earthquake ground motions for performing response-history analyses,” *NIST GCR 11-917-15*, NIST, Gaithersburg, MD.
- Reiter, L. (1990). *Earthquake hazard analysis: Issues and insights*. Columbia University Press, New York.
- Schnabel, P. B. , Lysmer, J., and Seed, H. B. (1972). “SHAKE—A computer program for earthquake response analysis of horizontally layered sites.” *Report EERC 72-12* , Earthquake Engineering Research Center, University of California, Berkeley, CA.
- Shahi, S. K., Ling, T., Baker, J. W., and Jayaram, N. (2011). *New ground motion selection procedures and selected motions for the PEER transportation research program* , Pacific Earthquake Engineering Research Center, Berkeley, CA.
- Stewart, J. P., Chiou, S. J., Bray, J. D., Graves, R. W., Sommerville, P. G., and Abrahamson, N. A. (2002). “Ground motion evaluation procedures for performance-based design.” *J. Soil Dyn. Earthq. Eng.* , 22, 9–12.
- Wallace, J. W., Segura, C., and Tran, T. (2013). *Shear design of structural walls*, Proc., 10th International Conference on Urban Earthquake Engineering, Tokyo Institute of Technology, Tokyo.
- Zareian, F., and Medina, R. (2010). “A practical method for proper modeling of structural damping in I nelastic plane structural systems,” *J. Comput. Struct.* 88(1–2), 45–53.

OTHER REFERENCES (NOT CITED)

- ASCE. (2014). *Seismic evaluation and retrofit of existing buildings*. ASCE/SEI Standard 41-13, ASCE, Reston, VA.
- Haselton, C. B., and Deierlein, G. G. (2007). *Assessing seismic collapse safety of modern reinforced concrete frame buildings* , PEER Report 2007/08, Pacific Earthquake Engineering Research Center, University of California, Berkeley, CA.

COMMENTARY TO CHAPTER 17, SEISMIC DESIGN REQUIREMENTS FOR SEISMICALLY ISOLATED STRUCTURES

C17.1 GENERAL

Seismic isolation, also referred to as base isolation because of its common use at the base of building structures, is a design method used to substantially decouple the response of a structure from potentially damaging horizontal components of earthquake motions. This decoupling can result in response that is significantly reduced from that of a conventional, fixed-base building.

The significant damage to buildings and infrastructure following large earthquakes over the last three decades has led to the rapid growth of seismic isolation technology and the development of specific guidelines for the design and construction of seismically isolated buildings and bridges in the United States, as well as standardized testing procedures of isolation devices.

Design requirements for seismically isolated building structures were first codified in the United States as an appendix to the 1991 Uniform Building Code, based on “General Requirements for the Design and Construction of Seismic-Isolated Structures” developed by the State Seismology Committee of the Structural Engineers Association of California. In the intervening years, those provisions have developed along two parallel tracks into the design requirements in Chapter 17 of the ASCE/SEI 7 standard and the rehabilitation requirements in Section 9.2 of ASCE/SEI 41 (2007), *Seismic Rehabilitation of Existing Buildings*. The design and analysis methods of both standards are similar, but ASCE/SEI 41 allows more relaxed design requirements for the superstructure of rehabilitated buildings. The basic concepts and design principles of seismic isolation of highway bridge structures were developed in parallel and first codified in the United States in the 1990 AASHTO provisions *Guide Specifications for Seismic Isolation Design*. The subsequent version of this code (AASHTO 1999) provides a systematic approach to determining bounding limits for analysis and design of isolator mechanical properties.

The present edition of the ASCE/SEI 7, Chapter 17, provisions contains significant modifications with respect to superseded versions, intended to facilitate the design and implementation process of seismic isolation, thus promoting the expanded use of the technology. Rather than addressing a specific method of seismic isolation, the standard provides general design requirements applicable to a wide range of seismic isolation systems. Because the design requirements are general, testing of isolation-system hardware is required to confirm the engineering parameters used in the design and to verify the overall adequacy of the isolation system. Use of isolation systems whose adequacy is not proved by testing is prohibited. In general, acceptable systems (a) maintain horizontal and vertical stability when subjected to design displacements, (b) have an inherent restoring force defined as increasing resistance with increasing displacement, (c) do not degrade significantly under repeated cyclic load, and (d) have quantifiable engineering parameters (such as force-deflection characteristics and damping).

The lateral force-displacement behavior of isolation systems can be classified into four categories, as shown in Figure C17.1-1, where each idealized curve has the same design displacement, D_D .

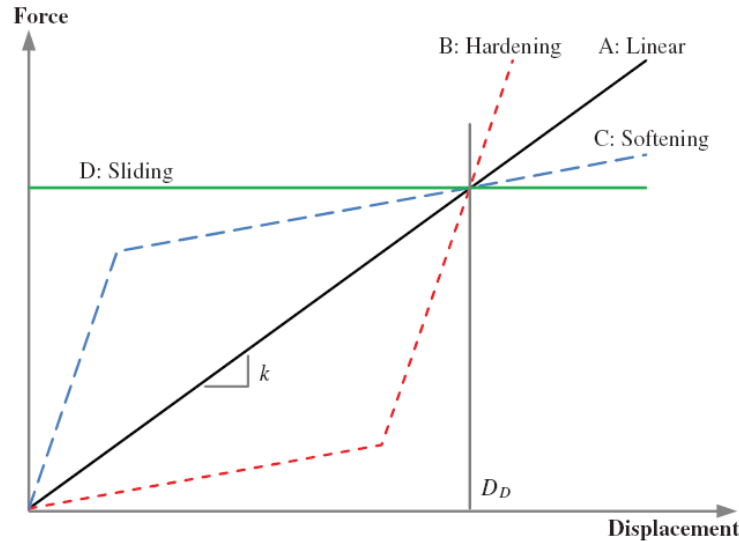

FIGURE C17.1-1 Idealized Force-Deflection Relationships for Isolation Systems (Stiffness Effects of Sacrificial Wind-Restraint Systems Not Shown for Clarity)

A linear isolation system (Curve A) has an effective period that is constant and independent of the displacement demand, where the force generated in the superstructure is directly proportional to the displacement of the isolation system.

A hardening isolation system (Curve B) has a low initial lateral stiffness (or equivalently a long effective period) followed by a relatively high second stiffness (or a shorter effective period) at higher displacement demands. Where displacements exceed the design displacement, the superstructure is subjected to increased force demands, while the isolation system is subject to reduced displacements, compared to an equivalent linear system with equal design displacement, as shown in Figure C17.1-1.

A softening isolation system (Curve C) has a relatively high initial stiffness (short effective period) followed by a relatively low second stiffness (longer effective period) at higher displacements. Where displacements exceed the design displacement, the superstructure is subjected to reduced force demands, while the isolation system is subject to increased displacement demand than for a comparable linear system.

The response of a purely sliding isolation system without lateral restoring force capabilities (Curve D) is governed by friction forces developed at the sliding interface. With increasing displacements, the effective period lengthens while loads on the superstructure remain constant. For such systems, the total displacement caused by repeated earthquake cycles is highly dependent on the characteristics of the ground motion and may exceed the design displacement, D_D . Since these systems do not have increasing resistance with increasing displacement, which helps to recenter the structure and prevent collapse, the procedures of the standard cannot be applied, and use of the system is prohibited.

Chapter 17 establishes isolator design displacements, shear forces for structural design, and other specific requirements for seismically isolated structures based on MCE_R only. All other design requirements, including loads (other than seismic), load combinations, allowable forces and stresses, and horizontal shear distribution, are the same as those for conventional, fixed-base structures. The main changes incorporated in this edition of the provisions include the following:

- Modified calculation procedure for the elastic design base shear forces from the design earthquake (DE) event to the MCE_R event using a consistent set of upper and lower bound

stiffness properties and displacements. This modification simplifies the design and analysis process by focusing only on the MCE_R event.

- Relaxed permissible limits and criteria for the use of the equivalent lateral force (ELF) procedure. This modification minimizes the need to perform complex and computationally expensive nonlinear time history analyses to design the superstructure and isolation system on many base-isolated structures.
- Enhanced definitions of design properties of the isolation system.
- Use of nominal properties in the design process of typical isolation bearings specified by the manufacturers based on prior prototype testing.
- These nominal properties are adjusted using the newly incorporated AASHTO (1999) lambda factor concept to account for response uncertainties and obtain upper and lower bound properties of the isolation system for the design process.
- New method for the vertical distribution of lateral forces associated with the ELF method of design.
- Simplified approach for incorporating a 5% accidental mass eccentricity in nonlinear time history analyses.
- Reduction in the required number of peer reviewers on a seismic isolation project from the current three to five to a minimum of one peer reviewer. Also, peer reviewers are not required to attend the prototype tests.
- Calculation procedure to estimate permanent residual displacements that may occur in seismic isolation applications with relatively long period high yield/friction levels, and small yield displacements under a wide range of earthquake intensity.

C17.2 GENERAL DESIGN REQUIREMENTS

In an ideal seismic isolation application, the lateral displacement of the structure is primarily accommodated through large lateral displacement or deformation of the isolation system rather than internal deformation of the superstructure above. Accordingly, the lateral force-resisting system of the superstructure above the isolation system is designed to have sufficient stiffness and strength to prevent large, inelastic displacements. Therefore, the standard contains criteria that limit the inelastic response of the superstructure. Although damage control is not an explicit objective of the standard, design to limit inelastic response of the structural system directly reduces the level of damage that would otherwise occur during an earthquake. In general, isolated structures designed in accordance with the standard are expected to

1. resist minor and moderate levels of earthquake ground motion without damage to structural elements, nonstructural components, or building contents, and
2. resist major levels of earthquake ground motion without failure of the isolation system, significant damage to structural elements, extensive damage to nonstructural components, or major disruption to facility function.

Isolated structures are expected to perform considerably better than fixed-based structures during moderate and major earthquakes. Table C17.2-1 compares the expected performance of isolated and fixed-based structures designed in accordance with the standard. Actual performance of an isolated structure should be determined by performing nonlinear time history analyses and computing interstory drifts and floor acceleration demands for an array of ground motions. Those results can be used to compute postearthquake repair costs of the structure using the FEMA P-58 performance-based earthquake engineering (PBEE) methodology (FEMA 2012) and/or large-scale simulations of direct and indirect costs using HAZUS software (FEMA 1999). Evaluation of seismic performance enhancement using seismic isolation should include its impact on floor accelerations, as well as interstory drifts, because these elements are key engineering demand parameters affecting damage in mechanical, electrical, and plumbing (MEP) equipment, ceilings and partitions, and building contents.

Table C17.2-1 Performance Expected for Minor, Moderate, and Major Earthquakes

Performance Measure	Earthquake Ground Motion Level ^a		
	Minor	Moderate	Major
Life safety: Loss of life or serious injury is not expected	F, I	F, I	F, I
Structural damage: Significant structural damage is not expected	F, I	F, I	I
Nonstructural damage: Significant nonstructural or content damage is not expected	F, I	I	I

^aF indicates fixed base; I indicates isolated.

Loss of function or discontinued building operation is not included in Table C17.2-1. For certain fixed-based facilities, loss of function would not be expected unless there is significant structural and nonstructural damage that causes closure or restricted access to the building. In other cases, a facility with only limited or no structural damage would not be functional as a result of damage to vital nonstructural components or contents. Seismic isolation, designed in accordance with these provisions, would be expected to mitigate structural and nonstructural damage and to protect the facility against loss of function. The postearthquake repair time required to rehabilitate the structure can also be determined through a FEMA P-58 PBEE evaluation.

Observed structural or nonstructural damage in fixed-based buildings caused by moderate and large earthquakes around the world have typically been associated with high-intensity lateral ground motion excitation rather than vertical acceleration. Gravity design procedures for typical structures result in structural sections and dimensions with relatively high safety factors for seismic resistance. Therefore, current code provisions for fixed-based (or isolated) buildings only require use of a vertical earthquake component, E_v , obtained from static analysis procedures per Sections 12.2.4.6 and 12.2.7.1, defined as $0.2S_{DS}D$ under the design earthquake, where D is the tributary dead load rather than explicit incorporation of vertical ground motions in the design analysis process. For seismic isolation, it should be noted that the term $0.2S_{DS}$ is replaced with $0.2S_{MS}$.

However, similar to fixed-based buildings, consideration of horizontal ground motion excitation alone may underestimate the acceleration response of floors and other building components. Portions of fixed-based and isolated structures may be especially sensitive to adverse structural response amplification induced by vertical ground motions including long spans, vertical discontinuities, or large cantilever elements. Certain nonstructural components, such as acoustic tile suspended ceiling systems, are also particularly vulnerable to the combination of vertical and horizontal ground motion effects. These building subassemblies or components may warrant additional vertical considerations. In addition, isolators with relatively low tributary gravity load and isolators located below columns that form part of the lateral force-resisting system can potentially have net uplift or tensile displacements caused by combined large vertical ground motion accelerations and global overturning. This uplift or bearing tension may induce high impact forces on the substructure, jeopardize the stability of the bearings, or result in bearing rupture.

Base-isolated structures located near certain fault characteristics that produce large vertical accelerations (e.g., hanging wall in reverse and reverse/oblique faults) are also more vulnerable and therefore may also require consideration of vertical ground motion excitation.

Vertical ground acceleration may affect the behavior of axial-load dependent isolation systems in the horizontal direction caused by potential coupling between horizontal and vertical response of the building structure.

Building response parameters that are expected to be affected by vertical excitation are vertical floor spectra and axial load demand on isolation bearings and columns, as discussed in Section C17.2.4.6. Isolated buildings with significant horizontal–vertical coupling are also expected to impart additional horizontal accelerations to the building at the frequencies of coupled modes that match the vertical motions.

If it is elected to investigate the effect of vertical ground motion acceleration on building response, one of the following analysis methods is suggested:

- Response spectrum analysis using horizontal and vertical spectrum (upward and downward).
- Response spectrum analysis using a vertical spectrum, combined with horizontal response spectrum analysis results using orthogonal combinations corresponding to the 100%–30%–30% rule.
- Three-dimensional response history analysis following the recommendations of Section C17.3.3 with explicit inclusion of vertical ground motion acceleration records.
- Horizontal response history analysis following the provisions of Section 17.3.3 considering the two limiting initial gravity load conditions defined per Section 17.2.7.1. Note that this analysis affects the effective characteristics of axial load-dependent isolators with resulting changes in base shear and displacement demands.

The structural model in these analyses should be capable of capturing the effects of vertical response and vertical mass participation, and should include the modeling recommendations in Section C17.6.2.

C17.2.4 Isolation System

C17.2.4.1 Environmental Conditions.

Environmental conditions that may adversely affect isolation system performance must be investigated thoroughly. Specific requirements for environmental considerations on isolators are included in the new Section 17.2.8. Unlike conventional materials whose properties do not vary substantially with time, the materials used in seismic isolators are typically subject to significant aging effects over the life span of a building structure. Because the testing protocol of Section 17.8 does not account for the effects of aging, contamination, scragging (temporary degradation of mechanical properties with repeated cycling), temperature, velocity effects, and wear, the designer must account for these effects by explicit analysis. The approach to accommodate these effects, introduced in the AASHTO specifications (AASHTO 1999), is to use property modification factors as specified in Section 17.2.8.4.

C17.2.4.2 Wind Forces.

Lateral displacement over the depth of the isolation region resulting from wind loads must be limited to a value similar to that required for other stories of the superstructure.

C17.2.4.3 Fire Resistance.

Where fire may adversely affect the lateral performance of the isolation system, the system must be protected to maintain the gravity-load resistance and stability required for the other elements of the superstructure supported by the isolation system.

C17.2.4.4 Lateral Restoring Force.

The restoring force requirement is intended to limit residual displacements in the isolation system resulting from any earthquake event so that the isolated structure will adequately withstand aftershocks and future earthquakes. The potential for residual displacements is addressed in Section C17.2.6.

C17.2.4.5 Displacement Restraint.

The use of a displacement restraint to limit displacements beyond the design displacement is discouraged. Where a displacement restraint system is used, explicit nonlinear response history analysis of the isolated structure for the MCE_R level is required using the provisions of Chapter 16 to account for the effects of engaging the displacement restraint.

C17.2.4.6 Vertical-Load Stability.

The vertical loads used to assess the stability of a given isolator should be calculated using bounding values of dead load, live load, and the peak earthquake demand at the MCE_R level. Because earthquake loads are reversible in nature, peak earthquake load should be combined with bounding values of dead and live load in a manner that produces both the maximum downward force and the maximum upward force on any isolator. Stability of each isolator should be verified for these two extreme values of vertical load at peak MCE_R displacement of the isolation system. In addition, all elements of the isolation system require testing or equivalent measures that demonstrate their stability for the MCE_R ground motion levels. This stability can be demonstrated by performing a nonlinear static analysis for an MCE_R response displacement of the entire structural system, including the isolation system, and showing that lateral and vertical stability are maintained. Alternatively, this stability can be demonstrated by performing a nonlinear dynamic analysis for the MCE_R motions using the same inelastic reductions as for the design earthquake (DE) and acceptable capacities except that member and connection strengths can be taken as their nominal strengths with resistance factors, Φ , taken as 1.0.

Vertical ground motion excitation affects bounding axial loads on isolation bearings and vertical stability design checks. The E component of load combination 5 of Section 2.3.2 should consider the maximum of E_v per code or the dynamic amplification from analysis when significant vertical acceleration is anticipated per Section C17.2.

C17.2.4.7 Overturning.

The intent of this requirement is to prevent both global structural overturning and overstress of elements caused by localized uplift. Isolator uplift is acceptable as long as the isolation system does not disengage from its horizontal-resisting connection details. The connection details used in certain isolation systems do not develop tension resistance, a condition which should be accounted for in the analysis and design. Where the tension capacity of an isolator is used to resist uplift forces, design and testing in accordance with Sections 17.2.4.6 and 17.8.2.5 must be performed to demonstrate the adequacy of the system to resist tension forces at the total maximum displacement.

C17.2.4.8 Inspection and Replacement.

Although most isolation systems do not require replacement following an earthquake event, access for inspection, repair, and replacement must be provided. In some cases (Section 17.2.6), recentering may be required. The isolation system should be inspected periodically as well as following significant earthquake events, and any damaged elements should be repaired or replaced.

C17.2.4.9 Quality Control.

A testing and inspection program is necessary for both fabrication and installation of the isolator units. Because of the rapidly evolving technological advances of seismic isolation, reference to specific standards for testing and inspection is difficult for some systems, while reference for some systems is possible (e.g., elastomeric bearings should follow ASTM D4014 requirements (ASTM 2012)). Similar standards are yet to be developed for other isolation systems. Special inspection procedures and load testing to verify manufacturing quality should therefore be developed for each project. The requirements may vary

depending on the type of isolation system used. Specific requirements for quality control testing are now given in Section 17.8.5.

C17.2.5 Structural System

C17.2.5.2 Minimum Building Separations.

A minimum separation between the isolated structure and other structures or rigid obstructions is required to allow unrestricted horizontal translation of the superstructure in all directions during an earthquake event. The separation dimension should be determined based on the total design displacement of the isolation system, the maximum lateral displacement of the superstructure above the isolation, and the lateral deformation of the adjacent structures.

C17.2.5.4 Steel Ordinary Concentrically Braced Frames.

Section 17.5.4.2 of this standard implies that only seismic force-resisting systems permitted for fixed-based building applications are permitted to be used in seismic isolation applications. Table 12.2-1 limits the height of steel ordinary concentrically braced frames (OCBFs) in fixed-based multistory buildings assigned Seismic Design Categories D and E to 35 ft (10.7 m) and does not permit them in buildings assigned to Seismic Design Category F. Section 17.2.5.4 permits them to be used for seismic isolation applications to heights of 160 ft (48.8 m) in buildings assigned to Seismic Design Categories D, E, and F, provided that certain additional requirements are satisfied. The additional design requirements that must be satisfied include that the building must remain elastic at the design earthquake level (i.e., $R_f = 1.0$), that the moat clearance displacement, D_{TM} , be increased by 20%, and that the braced frame be designed to satisfy Section F1.7 of AISC 341. It should be noted that currently permitted OCBFs in seismically isolated buildings assigned to Seismic Design Categories D and E also need to satisfy Section F1.7 of AISC 341.

Seismic isolation has the benefit of absorbing most of the displacement of earthquake ground motions, allowing the seismic force-resisting system to remain essentially elastic. Restrictions in Chapter 17 on the seismic force-resisting system limit the inelastic reduction factor to a value of 2 or less to ensure essentially elastic behavior. A steel OCBF provides the benefit of providing a stiff superstructure with reduced drift demands on drift-sensitive nonstructural components while providing significant cost savings as compared to special systems. Steel OCBFs have been used in the United States for numerous (perhaps most) new seismically isolated essential facility buildings since the seismic isolation was first introduced in the 1980s. Some of these buildings have had heights as high as 130 ft (39.6 m). The 160-ft (48.8-m) height limit was permitted for seismic isolation with OCBFs in high seismic zones when seismic isolation was first introduced in the building code as an appendix to the UBC in 1991. When height limits were restricted for fixed-based OCBFs in the 2000 NEHRP Recommended Provisions, it was not recognized the effect the restriction could have on the design of seismically isolated buildings. The Section 17.2.5.4 change rectifies that oversight. It is the judgment of this committee that height limits should be increased to the 160-ft (48.8-m) level, provided that the additional conditions are met.

The AISC Seismic Committee (Task Committee-9) studied the concept of steel OCBFs in building applications to heights of 160 ft (48.8 m) in high seismic areas. They decided that additional detailing requirements are required, which are found in Section F1.7 of AISC 341.

There has been some concern that steel ordinary concentrically braced frames may have an unacceptable collapse hazard if ground motions greater than MCE_R cause the isolation system to impact the surrounding moat wall. While there has not been a full FEMA P-695 (FEMA 2009) study of ordinary steel concentrically braced frame systems, a recent conservative study of one structure using OCBFs with $R_f = 1$ on isolation systems performed by Armin Masroor at SUNY Buffalo (Masroor and Mosqueda 2015) indicates that an acceptable risk of collapse (10% risk of collapse given MCE ground motions) is achieved if a 15–20% larger isolator displacement is provided. The study does not include the backup capacity of gravity

connections or the influence of concrete-filled metal deck floor systems on the collapse capacity. Even though there is no requirement to consider ground motions beyond the risk-targeted maximum considered earthquake ground motion in design, it was the judgment of this committee to provide additional conservatism by requiring 20% in moat clearance. It is possible that further P-695 studies will demonstrate that the additional 1.2 factor of displacement capacity may not be needed.

C17.2.5.5 Isolation System Connections.

This section addresses the connections of the structural elements that join isolators together. The isolators, joining elements, and connections comprise the isolation system. The joining elements are typically located immediately above the isolators; however, there are many ways to provide this framing, and this section is not meant to exclude other types of systems. It is important to note that the elements and the connections of the isolation system are designed for V_b level forces, while elements immediately above the isolation system are designed for V_s level forces.

Although ductility detailing for the connections in the isolation system is not required, and these elements are designed to remain elastic with V_b level forces using $R = 1.0$, in some cases it may still be prudent to incorporate ductility detailing in these connections (where possible) to protect against unforeseen loading. This incorporation has been accomplished in the past by providing connection details similar to those used for a seismic force-resisting system of Table 12.2-1, with connection moment and shear strengths beyond the code minimum requirements. Ways of accomplishing this include factoring up the design forces for these connections, or providing connections with moment and shear strengths capable of developing the expected plastic moment strength of the beam, similar to AISC 341 or ACI 318 requirements for ordinary moment frames (OMFs).

C17.2.6 Elements of Structures and Nonstructural Components.

To accommodate the differential horizontal and vertical movement between the isolated building and the ground, flexible utility connections are required. In addition, stiff elements crossing the isolation interface (such as stairs, elevator shafts, and walls) must be detailed to accommodate the total maximum displacement without compromising life safety provisions.

The effectiveness and performance of different isolation devices in building structures under a wide range of ground motion excitations have been assessed through numerous experimental and analytical studies (Kelly et al. 1980, Kelly and Hodder 1981, Kelly and Chaloub 1990; Zayas et al. 1987; Constantinou et al. 1999; Warn and Whittaker 2006; Buckle et al. 2002; Kelly and Konstantinidis 2011). The experimental programs included in these studies have typically consisted of reduced-scale test specimens, constructed with relatively high precision under laboratory conditions. These studies initially focused on elastomeric bearing devices, although in recent years the attention has shifted to the single- and multiconcave friction pendulum bearings. The latter system provides the option for longer isolated periods.

Recent full-scale shake table tests (Ryan et al. 2012) and analytical studies (Katsaras 2008) have shown that the isolation systems included in these studies with a combination of longer periods, relatively high yield/friction levels and small yield displacements will result in postearthquake residual displacements. In these studies, residual displacements ranging from 2 to 6 in. (50 to 150 mm) were measured and computed for isolated building structures with a period of 4 seconds or greater and a yield level in the range of 8 to 15% of the structure's weight. This permanent offset may affect the serviceability of the structure and possibly jeopardize the functionality of elements crossing the isolation plane (such as fire protection and weatherproofing elements, egress/entrance details, elevators, and joints of primary piping systems). Since it may not be possible to recenter some isolation systems, isolated structures with such characteristics should be detailed to accommodate these permanent offsets.

The Katsaras report (2008) provides recommendations for estimating the permanent residual displacement in any isolation system based on an extensive analytical and parametric study. The residual displacements measured in full-scale tests (Ryan et al. 2012) are reasonably predicted by this procedure, which uses an idealized bilinear isolation system, shown in Figure C17.2-1. The three variables that affect the residual displacement are the isolated period (based on the second slope stiffness K_D), the yield/friction level (F_0), and the yield displacement (D_y).

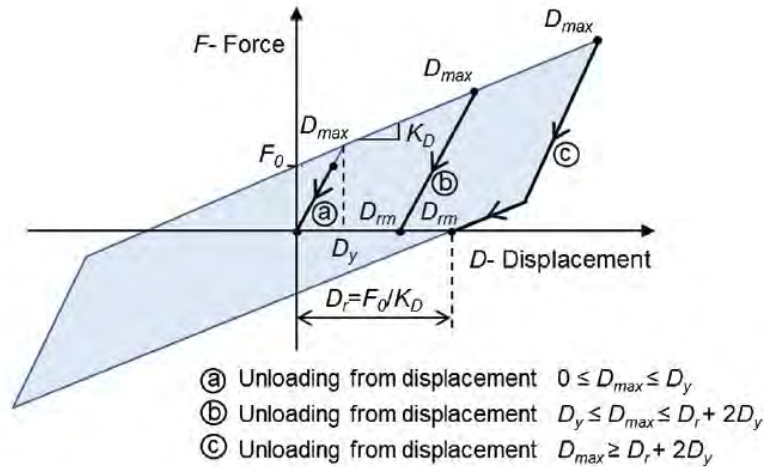

FIGURE C17.2-1 Definitions of Static Residual Displacement D_{rm} for a Bilinear Hysteretic System

The procedure for estimating the permanent residual displacement, D_{rd} (see Eq. (C17.2-1)) is a function of the system yield displacement D_y , the static residual displacement, $D_r = F_0 / K_p$, and D_{rm} , which is a function of D_m , the maximum earthquake displacement shown in Table C17.2-2. For most applications, D_{rm} is typically equal to D_r .

$$D_{rd} = \frac{0.87D_{rm}}{\left(1 + 4.3 \frac{D_{rm}}{D_r}\right) \left(1 + 31.7 \frac{D_y}{D_r}\right)} \quad (C17.2-1)$$

Table C17.2-2 Values of Static Residual Displacement, D_{rm}

Range of Maximum Displacement, D_{max}	Static Residual Displacement, D_{rm}
$0 \leq D_{max} \leq D_y$	0
$D_y \leq D_{max} < D_r + 2D_y$	$D_r (D_{max} - D_y) / (D_r + D_y)$
$D_r + 2D_y \leq D_{max}$	D_r

Thus, there is a simple two-step process to estimate the permanent residual displacement, D_{rd} :

- Calculate the static residual displacement, D_r , based on the isolated period (using the second slope stiffness, K_D) and the yield/friction levels. Table C17.2-3 provides values of D_r for a range of periods from 2.5 to 20 seconds and a range of yield/friction levels from 0.03 W to 0.15 W .
- Using the value of D_r calculated for the isolation system and the yield displacement, D_y , of the system, the permanent residual displacement, D_{rd} , can be calculated from Eq. (C17.2-1), and Tables C17.2-4 and C17.2-5 provide the residual displacements for earthquake displacements (D_m) of 10 in. and 20 in. (250 mm to 500 mm), respectively.

Table C17.2-3 Values of Static Residual Displacement, D_r (in.), for Various Isolated Periods, T (s), and Yield/Friction Levels,

(s)	0.03	0.06	0.09	0.12	0.15
2.5	1.8	3.6	5.3	7.1	8.9
2.8	2.4	4.7	7.1	9.5	11.9
3.5	3.6	7.1	10.7	14.2	17.8
4.0	4.7	9.5	14.2	19.0	23.7
5.0	7.2	14.5	21.7	28.9	36.1
5.6	9.2	18.5	27.7	37.0	46.2
6.0	10.7	21.3	32.0	42.7	53.3
7.0	14.2	28.4	42.7	56.9	71.1
8.0	18.7	37.4	56.2	74.9	93.6
9.0	23.7	47.4	71.1	94.8	118.5
20.1	118.5	237.0	355.5	474.0	592.5

Note: 1 in. = 25 mm.

The cells with bold type in Tables C17.2-4 and C17.2-5 correspond to permanent residual displacements exceeding 2.0 in. (50 mm). Note that for yield displacements of approximately 2.0 in. (50 mm), residual displacements will not occur for most isolation systems.

Table C17.2-4 Permanent Residual Displacement, D_{rd} , for a Maximum Earthquake Displacement, D_m , of 10 in. (250 mm)

D_y (in.)								
D_r (in.)	0.005	0.01	0.02	0.20	0.39	0.59	0.98	1.97
4.0	0.63	0.60	0.56	0.25	0.16	0.11	0.07	0.04
7.9	1.28	1.25	1.21	0.73	0.50	0.39	0.26	0.14
11.9	1.86	1.84	1.79	1.22	0.90	0.71	0.50	0.27
15.8	2.32	2.30	2.25	1.67	1.29	1.04	0.75	0.43
19.8	2.72	2.70	2.66	2.07	1.65	1.37	1.01	0.59
23.7	3.08	3.06	3.02	2.43	1.99	1.68	1.27	0.76
27.7	3.39	3.37	3.34	2.75	2.30	1.97	1.51	0.92
31.6	3.68	3.66	3.62	3.05	2.59	2.24	1.75	1.09
35.6	3.93	3.91	3.87	3.32	2.85	2.49	1.97	1.25
39.5	4.16	4.14	4.11	3.56	3.09	2.73	2.19	1.41

Note: 1 in. = 25 mm.

Bold values designate D_{rd} values of 2 inches or more.

Table C17.2-5 Permanent Residual Displacements, D_{rd} , for a Maximum Earthquake Displacement, D_m , of 20 in. (500 mm)

D_y (in.)								
D_r (in.)	0.005	0.01	0.02	0.20	0.39	0.59	0.98	1.97
4.0	0.63	0.60	0.56	0.25	0.16	0.11	0.07	0.04
7.9	1.28	1.25	1.21	0.73	0.50	0.39	0.26	0.15
11.9	1.93	1.90	1.85	1.28	0.95	0.76	0.54	0.31
15.8	2.58	2.55	2.50	1.86	1.45	1.19	0.87	0.52
19.8	3.23	3.20	3.15	2.47	1.98	1.65	1.24	0.75
23.7	3.75	3.72	3.67	2.97	2.45	2.08	1.59	0.99

D_y (in.)								
D_r (in.)	0.005	0.01	0.02	0.20	0.39	0.59	0.98	1.97
27.7	4.22	4.20	4.15	3.45	2.90	2.50	1.95	1.24
31.6	4.67	4.64	4.60	3.90	3.33	2.90	2.30	1.50
35.6	5.08	5.06	5.02	4.32	3.74	3.30	2.65	1.76
39.5	5.47	5.45	5.41	4.72	4.13	3.67	2.99	2.02

Note: 1 in. = 25 mm.

Bold values designate D_{rd} values of 2 inches or more.

C17.2.8 Isolation System Properties.

This section defines and combines sources of variability in isolation system mechanical properties measured by prototype testing, permitted by manufacturing specification tolerances, and occurring over the life span of the structure because of aging and environmental effects. Upper bound and lower bound values of isolation system component behavior (e.g., for use in response history analysis procedures) and maximum and minimum values of isolation system effective stiffness and damping based on these bounding properties (e.g., for use in equivalent lateral force procedures) are established in this section. Values of property modification factors vary by product and cannot be specified generically in the provisions. Typical “default” values for the more commonly used systems are provided below. The designer and peer reviewer are responsible for determining appropriate values of these factors on a project-specific and product-specific basis.

This section also refines the concept of bounding (upper bound and lower bound) values of isolation system component behavior by

1. Explicitly including variability caused by manufacturing tolerances, aging, and environmental effects. ASCE/SEI 7-10 only addressed variability associated with prototype testing and
2. Simplifying design by basing bounding measures of amplitude-dependent behavior on only MCE_R ground motions. ASCE/SEI 7-10 used both design earthquake (DE) and MCE_R ground motions.

The new section also refines the concept of maximum and minimum effective stiffness and damping of the isolation system by use of revised formulas that

1. Define effective properties of the isolation system on bounding values of component behavior (i.e., same two refinements, described above) and
2. Eliminates the intentional conservatism of ASCE/SEI 7-10 that defines minimum effective damping in terms of maximum effective stiffness.

C17.2.8.2 Isolator Unit Nominal Properties.

Isolator manufacturers typically supply nominal design properties that are reasonably accurate and can be confirmed by prototype tests in the design and construction phases. These nominal properties should be based on past prototype tests as defined in Section 17.8.2; see Figure C17.2-2.

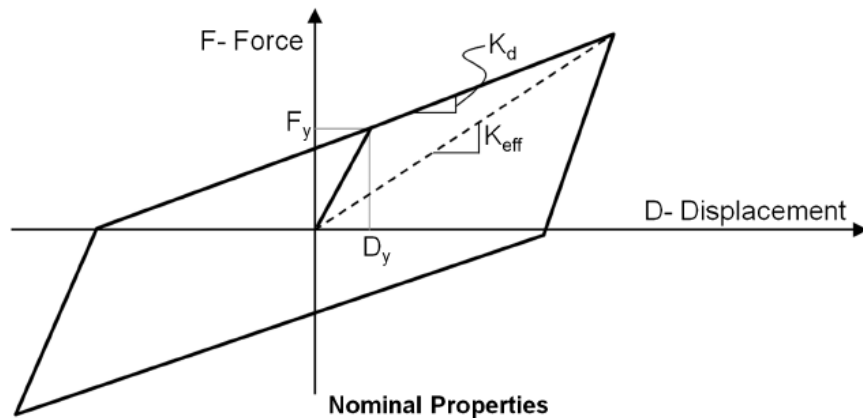

FIGURE C17.2-2 Example of the Nominal Properties of a Bilinear Force Deflection System

C17.2.8.3 Bounding Properties of Isolation System Components.

The methodology for establishing lower and upper bound values for isolator basic mechanical properties based on property modification factors was first presented in Constantinou et al. (1999). It has since then been revised in Constantinou et al. (2007) based on the latest knowledge of lifetime behavior of isolators. The methodology presented uses property modification factors to adjust isolator nominal properties based on considerations of natural variability in properties, effects of heating during cyclic motion, and the effects of aging, contamination, ambient temperature and duration of exposure to that temperature, and history of loading. The nominal mechanical properties should be based on prototype (or representative) testing on isolators not previously tested, at normal temperature and under dynamic loading.

The methodology also modifies the property modification factors to account for the unlikely situation of having several events of low probability of occurrence occur at the same time (i.e., maximum earthquake, aging, and low temperature) by use of property adjustment factors that are dependent on the significance of the structure analyzed (values range from 0.66 for a typical structure to 1.0 for a critical structure). This standard presumes that the property adjustment factor is 0.75. However, the registered design professional may opt to use the value of 1.0 based on the significance of the structure (e.g., health-care facilities or emergency operation centers) or based on the number of extreme events considered in the establishment of the property modification factor. For example, if only aging is considered, then a property adjustment factor of unity is appropriate.

Examples of application in the analysis and design of bridges may be found in Constantinou et al. (2011). These examples may serve as guidance in the application of the methodology in this standard. Constantinou et al. (2011) also presents procedures for estimating the nominal properties of lead-rubber and friction pendulum isolators, again based on the assumption that prototype test data are not available. Data used in the estimation of the range of properties were based on available test data, all of which were selected to heighten heating effects. Such data would be appropriate for cases of high-velocity motion and large lead core size or high friction values.

Recommended values for the specification tolerance on the average properties of all isolators of a given size isolator are typically in the $\pm 10\%$ to $\pm 15\%$ range. For a $\pm 10\%$ specification tolerance, the corresponding lambda factors would be $\lambda_{(\text{spec,max})} = 1.10$ and $\lambda_{(\text{spec,min})} = 0.90$. Variations in individual isolator properties are typically greater than the tolerance on the average properties of all isolators of a given

size as presented in Section 17.2.8.4. It is recommended that the isolator manufacturer be consulted when establishing these tolerance values.

Section 17.2.8.4 requires the isolation system to be designed with consideration given to environmental conditions, including aging effects, creep, fatigue, and operating temperatures. The individual aging and environmental factors are multiplied together and then the portion of the lambda factor differing from unity is reduced by 0.75 based on the assumption that not all of the maximum values will occur simultaneously. As part of the design process, it is important to recognize that there will be additional variations in the nominal properties because of manufacturing. The next section specifies the property modification factors corresponding to the manufacturing process or default values if manufacturer-specific data are not available. These factors are combined with the property modification factors (Section 17.2.8.4) to determine the maximum and minimum properties of the isolators (Section 17.2.8.5) for use in the design and analysis process.

The lambda-test values $\lambda_{\text{test,max}}$ and $\lambda_{\text{test,min}}$ are determined from prototype testing and shall bound the variability and degradation in properties caused by speed of motion, heating effects, and scragging from Item 2 of Section 17.8.2.2. The registered design professional (RDP) shall specify whether this testing is performed quasi-statically, as in Item 2(a), or dynamically, as in Item 2(b). When testing is performed quasi-statically, the dynamic effects shall be accounted for in analysis and design using appropriate adjustment of the lambda-test values.

Item 3 of the testing requirements of Section 17.8.2.2 is important for property determination since it is common to Item 2. Using this testing, the lambda-test values $\lambda_{\text{test,max}}$ and $\lambda_{\text{test,min}}$ may be determined by three fully reversed cycles of dynamic (at the effective period T_M) loading at the maximum displacement $1.0D_M$ on full-scale specimens. This test regime incorporates the effects of high-speed motion. The upper and lower bound values of K_d shall also envelop the $0.67D_M$ and $1.0D_M$ tests of Item 2 of Section 17.8.2.2. Therefore, the lambda-test values bound the effects of heating and scragging. As defined by Section 17.2.8.2, the nominal property of interest is defined as the average among the three cycles of loading. $\lambda_{\text{test,max}}$ shall be determined as the ratio of the first cycle property to the nominal property value.

$\lambda_{\text{test,min}}$ shall be determined as the ratio of the property value at a representative cycle, determined by the RDP, to the nominal property value. The number of cycles shall be representative of the accepted performance of the isolation system for the local seismic hazard conditions, with the default cycle being the third cycle. A critique and guidance are provided in McVitty and Constantinou (2015).

C17.2.8.4 Property Modification Factors.

The lambda factors are used to establish maximum and minimum mathematical models for analysis, the simplest form of which is the linear static procedure used to assess the minimum required design base shear and system displacements. More complex mathematical models account for various property variation effects explicitly (e.g., velocity, axial load, bilateral displacement, and instantaneous temperature). In this case, the cumulative effect of the lambda factors reduces (the combined lambda factor is closer to 1.0). However, some effects, such as specification tolerance and aging, are likely to always remain since they cannot be accounted for in mathematical models. Default lambda factors are provided in Table C17.2-6 as isolators from unknown manufacturers that do not have qualification test data. Default lambda factors are provided in Table C17.2-7 for most common types of isolators fabricated by quality manufacturers. Note that this table does not have any values of property modification factors for the actual stiffness (K_d) of sliding isolators. It is presumed that sliding isolators, whether flat or spherical, are produced with sufficiently high accuracy that their actual stiffness characteristics are known. The RDP may assign values of property modification factors different than unity for the actual stiffness of sliding bearings on the basis

of data obtained in the prototype testing or on the basis of lack of experience with unknown manufacturers. Also note that this table provides values of property modification factors to approximately account for uncertainties in the materials and manufacturing methods used. These values presume lack of test data or incomplete test data and unknown manufacturers. For example, the values in Table C17.2-6 for sliding bearings presume unknown materials for the sliding interfaces so that there is considerable uncertainty in the friction coefficient values. Also, the data presume that elastomers used in elastomeric bearings have significant scragging and aging. Moreover, for lead-rubber bearings, the data in the table presume that there is considerable uncertainty in the starting value (before any hysteretic heating effects) of the effective yield strength of lead.

Table C17.2-6 Default Upper and Lower Bound Multipliers for Unknown Manufacturers

Variable	Unlubricated Interfaces, μ or Q_d	Lubricated (Liquid) Interfaces, μ or Q_d	Plain Low Damping Elastomeric, K	Lead Rubber Bearing (LRB), K_d	Lead Rubber Bearing (LRB), Q_d	High-Damping Rubber (HDR), K_d	High-Damping Rubber (HDR), Q_d
Example: Aging and Environmental Factors							
Aging, λ_a	1.3	1.8	1.3	1.3	1	1.4	1.3
Contamination, λ_c	1.2	1.4	1	1	1	1	1
Example Upper Bound, $\lambda_{(ae,max)}$	1.56	2.52	1.3	1.3	1	1.4	1.3
Example Lower Bound, $\lambda_{(ae,min)}$	1	1	1	1	1	1	1
Example: Testing Factors							
All cyclic effects, Upper	1.3	1.3	1.3	1.3	1.6	1.5	1.3
All cyclic effects, Lower	0.7	0.7	0.9	0.9	0.9	0.9	0.9
Example Upper Bound, $\lambda_{(test,max)}$	1.3	1.3	1.3	1.3	1.6	1.5	1.3

Variable	Unlubricated Interfaces, μ or Q_d	Lubricated (Liquid) Interfaces, μ or Q_d	Plain Low Damping Elastomeric, K	Lead Rubber Bearing (LRB), K_d	Lead Rubber Bearing (LRB), Q_d	High-Damping Rubber (HDR), K_d	High-Damping Rubber (HDR), Q_d
Example Lower Bound, $\lambda_{(test,min)}$	0.7	0.7	0.9	0.9	0.9	0.9	0.9
$\lambda_{(PM,max)} = (1 + (0.75 * (\lambda_{(ac,max)} - 1)))$	1.85	2.78	1.59	1.59	1.6	1.95	1.59
$\lambda_{(PM,min)} = (1 - (0.75 * (1 - \lambda_{(ac,min)})))$	0.7	0.7	0.9	0.9	0.9	0.9	0.9
Lambda factor for Spec. Tolerance, $\lambda_{(spec,max)}$	1.15	1.15	1.15	1.15	1.15	1.15	1.15
Lambda factor for Spec. Tolerance, $\lambda_{(spec,min)}$	0.85	0.85	0.85	0.85	0.85	0.85	0.85
Upper Bound Design Property Multiplier	2.12	3.2	1.83	1.83	1.84	2.24	1.83
Lower Bound Design Property Multiplier	0.6	0.6	0.77	0.77	0.77	0.77	0.77
Default Upper Bound Design Property Multiplier	2.1	3.2	1.8	1.8	1.8	2.2	1.8
Default Lower Bound Design Property Multiplier	0.6	0.6	0.8	0.8	0.8	0.8	0.8

Note: λ_{PM} is the lambda value for testing and environmental effects.

Table C17.2-7 Default Upper and Lower Bound Multipliers for Quality Manufacturers

Variable	Unlubricated PTFE, μ	Lubricated PTFE, μ	Rolling/Sliding, K_2	Plain Elastomers, K	Lead rubber bearing (LRB), K_2	Lead rubber bearing (LRB), Q_d	High-Damping Rubber (HDR), Q_d	High-Damping Rubber (HDR), K_d
Example: Aging and Environmental Factors								
Aging, λ_a	1.10	1.50	1.00	1.10	1.10	1.00	1.20	1.20
Contamination, λ_+	1.10	1.10	1.00	1.00	1.00	1.00	1.00	1.00
Example Upper Bound, $\lambda_{(ac,max)}$	1.21	1.65	1.00	1.10	1.10	1.00	1.20	1.20
Example Lower Bound, $\lambda_{(ac,min)}$	1.00	1.00	1.00	1.00	1.00	1.00	1.00	1.00
Example: Testing Factors								
All cyclic effects, Upper	1.20	1.30	1.00	1.03	1.03	1.30	1.50	1.30
All cyclic effects, Lower	0.95	0.95	1.00	0.98	0.98	0.95	0.95	0.95
Example Upper Bound, $\lambda_{(test,max)}$	1.20	1.30	1.00	1.03	1.03	1.30	1.50	1.30
Example Lower Bound, $\lambda_{(test,min)}$	0.95	0.95	1.00	0.98	0.98	0.95	0.95	0.95
$\lambda_{(PM,max)} = (1 + (0.75 * (\lambda_{(ac,max)} - 1))) * \lambda_{(test,max)}$	1.39	1.93	1.00	1.11	1.11	1.30	1.73	1.50
$\lambda_{(PM,min)} = (1 - (0.75 * (1 - \lambda_{(ac,min)}))) * \lambda_{(test,min)}$	0.95	0.95	1.00	0.98	0.98	0.95	0.95	0.95
Lambda factor for Spec. Tolerance, $\lambda_{(spec,max)}$	1.15	1.15	1.00	1.15	1.15	1.15	1.15	1.15
Lambda factor for Spec. Tolerance, $\lambda_{(spec,min)}$	0.85	0.85	1.00	0.85	0.85	0.85	0.85	0.85

Variable	Unlubricated PTFE, μ	Lubricated PTFE, μ	Rolling/Sliding, K_2	Plain Elastomers, K	Lead rubber bearing (LRB), K_2	Lead rubber bearing (LRB), Q_d	High-Damping Rubber (HDR), Q_d	High-Damping Rubber (HDR), K_d
Upper Bound Design Property Multiplier	1.60	2.22	1.00	1.27	1.27	1.50	1.98	1.72
Lower Bound Design Property Multiplier	0.81	0.81	1.00	0.83	0.83	0.81	0.81	0.81
Default Upper Bound Design Property Multiplier	1.6	2.25	1	1.3	1.3	1.5	2	1.7
Default Lower Bound Design Property Multiplier	0.8	0.8	1	0.8	0.8	0.8	0.8	0.8

Note: λ_{PM} is the lambda value for testing and environmental effects.

Accordingly, there is a considerable range in the upper and lower values of the property modification factors. Yet, these values should be used with caution since low-quality fabricators could use materials and vulcanization and manufacturing processes that result in even greater property variations. The preferred approach for establishing property modification factors is through rigorous qualification testing of materials and manufacturing methods by a quality manufacturer, and dynamic prototype testing of full-size specimens, and by quality control testing at project-specific loads and displacements. These test data on similar-sized isolators take precedence over the default values.

For elastomeric isolators, lambda factors and prototype tests may need to address axial–shear interaction, bilateral deformation, load history including first cycle effects and the effects of scragging of virgin elastomeric isolators, ambient temperature, other environmental loads, and aging effects over the design life of the isolator.

For sliding isolators, lambda factors and prototype tests may need to address contact pressure, rate of loading or sliding velocity, bilateral deformation, ambient temperature, contamination, other environmental loads, and aging effects over the design life of the isolator.

Rate of loading or velocity effects are best accounted for by dynamic prototype testing of full-scale isolators. Property modification factors for accounting for these effects may be used in lieu of dynamic testing.

Generally, ambient temperature effects can be ignored for most isolation systems if they are in conditioned space where the expected temperature varies between 30°F and 100°F.

The following comments are provided in the approach to be followed for the determination of the bounding values of mechanical properties of isolators:

1. Heating effects (hysteretic or frictional) may be accounted for on the basis of a rational theory (e.g., Kalpakidis and Constantinou 2008, 2009; Kalpakidis et al. 2010) so that only the effects of uncertainty in the nominal values of the properties, aging, scragging, and contamination need to be considered. This is true for lead-rubber bearings where lead of high purity and of known

thermomechanical properties is used. For sliding bearings, the composition of the sliding interface affects the relation of friction to temperature and therefore cannot be predicted by theory alone. Moreover, heating generated during high-speed motion may affect the bond strength of liners. Given that there are numerous sliding interfaces (and that they are typically proprietary), that heating effects in sliding bearings are directly dependent on pressure and velocity, and that size is important in the heating effects (Constantinou et al. 2007), full-scale dynamic prototype and production testing are very important for sliding bearings.

2. Heating effects are important for sliding bearings and the lead core in lead-rubber bearings. They are not important and need not be considered for elastomeric bearings of either low or high damping. The reason for this is described in Constantinou et al. (2007), where it has been shown, based on theory and experimental evidence, that the rise in temperature of elastomeric bearings during cyclic motion (about one degree centigrade per cycle) is too small to significantly affect their mechanical properties. Prototype and production testing of full-size specimens at the expected loads and displacements should be sufficient to detect poor material quality and poor material bonding in plain elastomeric bearings, even if done quasi-statically.
3. Scragging and recovery to the virgin rubber properties (see Constantinou et al. 2007 for details) are dependent on the rubber compound, size of the isolator, the vulcanization process, and the experience of the manufacturer. Also, it has been observed that scragging effects are more pronounced for rubber of low shear modulus and that the damping capacity of the rubber has a small effect. It has also been observed that some manufacturers are capable of producing low-modulus rubber without significant scragging effects, whereas others cannot. It is therefore recommended that the manufacturer should present data on the behavior of the rubber under virgin conditions (not previously tested and immediately after vulcanization) so that scragging property modification factors can be determined. This factor is defined as the ratio of the effective stiffness in the first cycle to the effectiveness stiffness in the third cycle, typically obtained at a representative rubber shear strain (e.g., 100%). It has been observed that this factor can be as high as, or can exceed, a value of 2.0 for shear-modulus rubber less than or equal to 0.45 MPa (65 psi). Also, it has been observed that some manufacturers can produce rubber with a shear modulus of 0.45 MPa (65 psi) and a scragging factor of approximately 1.2 or less. Accordingly, it is preferred to establish this factor by testing for each project or to use materials qualified in past projects.
4. Aging in elastomeric bearings has in general small effects (typically increases in stiffness and strength of the order of 10% to 30% over the lifetime of the structure), provided that scragging is also minor. It is believed that scragging is mostly the result of incomplete vulcanization, which is thus associated with aging as chemical processes in the rubber continue over time. Inexperienced manufacturers may produce low shear modulus elastomers by incomplete vulcanization, which should result in significant aging.
5. Aging in sliding bearings depends on the composition of the sliding interface. There are important concerns with bimetallic interfaces (Constantinou et al. 2007), even in the absence of corrosion, so that they should be penalized by large aging property modification factors or simply not used. Also, lubricated interfaces warrant higher aging and contamination property modification factors. The designer can refer to Constantinou et al. (2007) for detailed values of the factor depending on the conditions of operation and the environment of exposure. Note that lubrication is meant to be *liquid* lubrication typically applied either directly at the interface or within dimples. Solid lubrication in the form of graphite or similar materials that are integrated in the fabric of liners and used in contact with stainless steel for the sliding interface does not have the problems experienced by liquid lubrication.

C17.2.8.5 Upper Bound and Lower Bound Force-Deflection Behavior of Isolation System Components.

An upper and lower bound representation of each type of isolation system component shall be developed using the lambda factors developed in Section 17.2.8.4. An example of a bilinear force deflection loop is shown in Figure C17.2-2. In C17.2-3, the upper and lower bound lambda factors are applied to the nominal properties of the yield/friction level and the second or bilinear slope of the lateral force-displacement curve to determine the upper and lower bound representation of an isolation system component. The nomenclature shown in Figure C17.2-3 is important to note. The effective stiffness and effective damping are calculated for both the upper and lower bound properties at the corresponding D_M . The maximum and minimum effective stiffness and effective damping are then developed from these upper and lower bound lateral force-displacement relationships in Section 17.2.8.6.

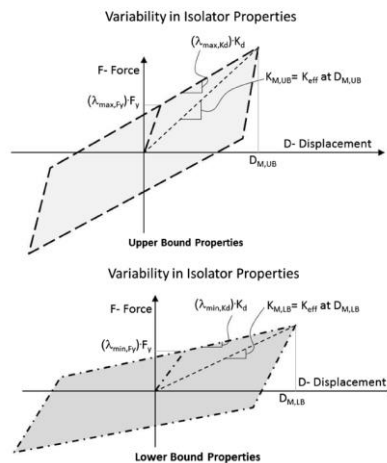

FIGURE C17.2-3 Example of the Upper and Lower Bound Properties of a Bilinear Force Deflection System

C17.3 SEISMIC GROUND MOTION CRITERIA

C17.3.1 Site-Specific Seismic Hazard.

This new section consolidates existing site-specific hazard requirements from other sections.

C17.3.3 MCE_R Ground Motion Records.

The MCE_R spectrum is constructed from the S_{MS} , S_{M1} parameters of Section 11.4.5, or 11.4.6, or 11.4.7.

When vertical excitation is included in isolated building response history analysis or response spectrum analysis, it is recommended that the vertical design spectra be computed by one of the following methods:

1. 2009 NEHRP Provisions (FEMA 2009) in new Chapter 23, equivalent to Annex A of Chapter 15, where the term S_{DS} is replaced with S_{MS} . The vertical spectrum is computed based on near-fault or far-fault conditions through the parameter S_s (short-period horizontal spectral acceleration for the site), as well as soil conditions (site classification).
2. Site-specific seismic hazard analysis using ground motion prediction equations for vertical shaking.
3. Multiplying the ordinates of the target spectrum corresponding to horizontal shaking by empirically based vertical-to-horizontal ratios that may be dependent on vertical period, site class, and proximity to fault.

4. Other approaches discussed in NIST GCR 11-917-15 (NIST 2011) consisting of a vertical conditional spectrum or conditional mean spectrum, envelope scaling, and mean spectral matching, or others.

Where response history analysis procedures are used, MCE_R ground motions should consist of not less than seven pairs of appropriate horizontal acceleration components.

Where vertical excitation is included in isolated building response history analysis, scaling of the vertical ground motion component may follow one of the following recommended procedures:

- The vertical motions are spectrally matched to the design vertical spectrum using a vertical period range of $0.2T_v$ to $1.5T_v$, where T_v is the building's primary vertical period of vibration. A wider period range may be considered because of uncertainty in the estimation of the primary vertical period of the building.
- The vertical component should be scaled by the same factor as the horizontal ground motion component(s). If the vertical component is included in the response of the structure, the response spectra of the vertical components of the records should be evaluated for reasonableness by comparing their spectra with a design vertical spectrum (NIST 2011).

If achieving a spectral fit to the vertical component spectrum is desirable, the vertical components of the selected records can be scaled by different factors than those used for horizontal components. Amplitude scaling of vertical components to a target vertical spectrum can be used using a least square error fit to a vertical period range of $0.2T_v$ to $1.5T_v$, where T_v is the building's primary vertical period of vibration. A wider period range may be considered in this case because of uncertainty in the estimation of the primary vertical period of the building.

C17.4 ANALYSIS PROCEDURE SELECTION

Three different analysis procedures are available for determining design-level seismic loads: the equivalent lateral force (ELF) procedure, the response spectrum procedure, and the response history procedure. For the ELF procedure, simple equations computing the lateral force demand at each level of the building structure (similar to those for conventional, fixed-base structures) are used to determine peak lateral displacement and design forces as a function of spectral acceleration and isolated-structure period and damping. The provisions of this section permit increased use of the ELF procedure, recognizing that the ELF procedure is adequate for isolated structures whose response is dominated by a single translational mode of vibration and whose superstructure is designed to remain essentially elastic (limited ductility demand and inelastic deformations) even for MCE_R level ground motions. The ELF procedure is now permitted for the design of isolated structures at all sites (except Site Class F) as long as the superstructure is regular (as defined in new Section 17.2.2), has a fixed-base period (T) that is well separated from the isolated period (T_{min}), and the isolation system meets certain "response predictability" criteria with which typical and commonly used isolation systems comply.

The design requirements for the structural system are based on the forces and drifts obtained from the MCE_R earthquake using a consistent set of upper and lower bound isolation system properties, as discussed in Section C17.5. The isolation system—including all connections, supporting structural elements, and the "gap"—is required to be designed (and tested) for 100% of MCE_R demand. Structural elements above the isolation system are now designed to remain essentially elastic for the MCE_R earthquake. A similar fixed-base structure would be designed for design earthquake loads (two-thirds MCE_R) reduced by a factor of 6 to 8 rather than the MCE_R demand reduced by a factor of up to 2 for a base-isolated structure.

C17.5 EQUIVALENT LATERAL FORCE PROCEDURE

The lateral displacements given in this section approximate peak earthquake displacements of a single-degree-of-freedom, linear-elastic system of period, T , and effective damping, β . Eqs. (17.5-1) and (17.5-3) of ASCE 7-10 provided the peak displacement in the isolation system at the center of mass for both the DE and MCE_R earthquakes, respectively. In these prior equations, as well as the current equation, the spectral acceleration terms at the isolated period are based on the premise that the longer period portion of the response spectra decayed as $1/T$. This is a conservative assumption and is the same as that required for design of a conventional, fixed-base structure of period T_M . A damping factor γ , is used to decrease (or increase) the computed displacement demand where the effective damping coefficient of the isolation system is greater (or smaller) than 5% of critical damping. A comparison of values obtained from Eq. (17.5-1) and those obtained from nonlinear time history analyses are given in Kircher et al. (1988) and Constantinou et al. (1993).

The ELF formulas in this new edition compute minimum lateral displacements and forces required for isolation system design based only on MCE_R level demands, rather than on a combination of design earthquake and MCE_R levels, as in earlier editions of the provisions.

The calculations are performed separately for upper bound and lower bound isolation system properties, and the governing case shall be considered for design. Upper bound properties typically, but not always, result in a lower maximum displacement (D_M), higher damping (β_M), and higher lateral forces (V_s , V_{st} , and k).

Section 17.2.8 relates bounding values of effective period, stiffness, and damping of the isolation system to upper bound and lower bound lateral force-displacement behavior of the isolators.

C17.5.3 Minimum Lateral Displacements Required for Design

C17.5.3.1 Maximum Displacement.

The provisions of this section reflect the MCE_R -only basis for design and define maximum MCE_R displacement in terms of MCE_R response spectral acceleration, S_{M1} , at the appropriate T .

In addition, and of equal significance, the maximum displacement (D_M) and the damping modification factor (B_M) are determined separately for upper bound and lower bound isolation system properties. In earlier provisions, the maximum displacement (D_M) was defined only in terms of the damping associated with lower bound displacement, and this damping was combined with the upper bound stiffness to determine the design forces. This change is theoretically more correct, but it removes a significant conservatism in the ELF design of the superstructure. This reduction in superstructure design conservatism is offset by the change from design earthquake to MCE_R ground motions as the basis for superstructure design forces.

C17.5.3.2 Effective Period at the Maximum Displacement.

The provisions of this section are revised to reflect the MCE_R -only basis for design and associated changes in terminology (although maintaining the concept of effective period). The effective period T_M is also determined separately for the upper and lower bound isolation properties.

C17.5.3.3 Total Maximum Displacement.

The provisions of this section are revised to reflect the MCE_R -only basis for design and associated changes in terminology. Additionally, the formula for calculating total (translational and torsional) maximum MCE_R

displacement has been revised to include a term and corresponding equations that reward isolation systems configured to resist torsion.

The isolation system for a seismically isolated structure should be configured to minimize eccentricity between the center of mass of the superstructure and the center of rigidity of the isolation system, thus reducing the effects of torsion on the displacement of isolation elements. For conventional structures, allowance must be made for accidental eccentricity in both horizontal directions. Figure C17.5-1 illustrates the terminology used in the standard. Eq. (17.5-3) provides a simplified formula for estimating the response caused by torsion in lieu of a more refined analysis. The additional component of displacement caused by torsion increases the design displacement at the corner of a structure by about 15% (for one perfectly square in plan) to about 30% (for one long and rectangular in plan) if the eccentricity is 5% of the maximum plan dimension. These calculated torsional displacements correspond to structures with an isolation system whose stiffness is uniformly distributed in plan. Isolation systems that have stiffness concentrated toward the perimeter of the structure, or certain sliding systems that minimize the effects of mass eccentricity, result in smaller torsional displacements. The standard permits values of D_{TM} as small as $1.15D_M$, with proper justification.

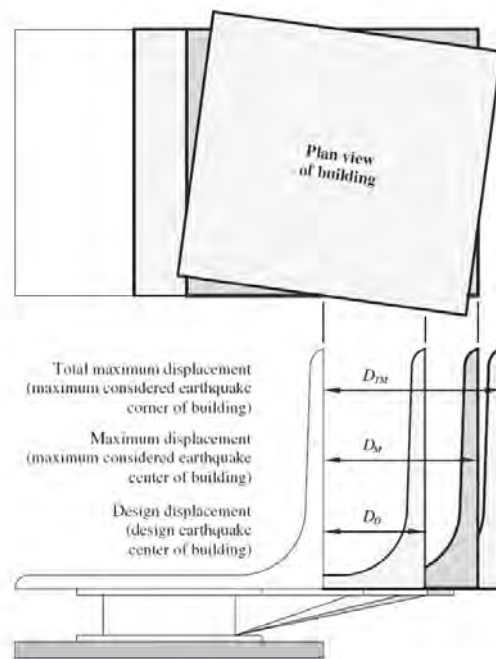

FIGURE C17.5-1 Displacement Terminology

C17.5.4 Minimum Lateral Forces Required for Design.

Figure C17.5-2 illustrates the terminology for elements at, below, and above the isolation system. Eq. (17.5-5) specifies the peak elastic seismic shear for design of all structural elements at or below the isolation system (without reduction for ductile response). Eq. (17.5-7) specifies the peak elastic seismic shear for design of structural elements above the isolation system. For structures that have appreciable inelastic-deformation capability, this equation includes an effective reduction factor ($R_l = 3R/8$ not exceeding 2). This factor ensures essentially elastic behavior of the superstructure above the isolators.

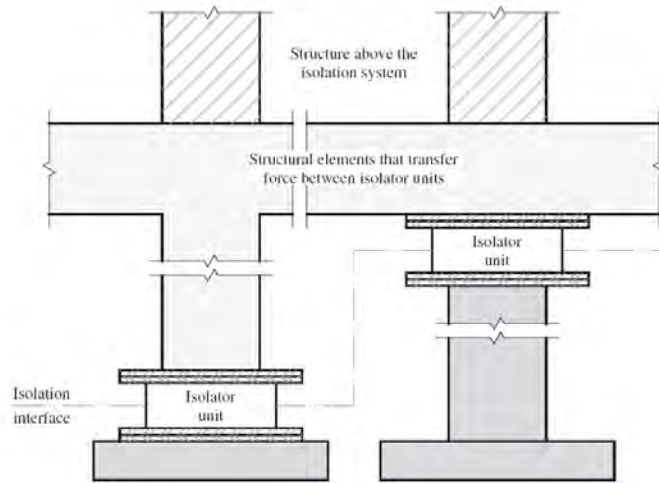

FIGURE C17.5-2 Isolation System Terminology

These provisions include two significant philosophic changes in the method of calculating the elastic base shear for the structure. In ASCE 7-10 and earlier versions of the provisions, the elastic design base shear forces were determined from the design earthquake (DE) using a mixture of the upper bound effective stiffness and the maximum displacement obtained using the lower bound properties of the isolation system, as shown schematically in Figure C17.5-3. This was known to be conservative. The elastic design base shear is now calculated from the MCE_R event with a consistent set of upper and lower bound stiffness properties, as shown in Eq. (17.5-5) and Figure C17.5-3.

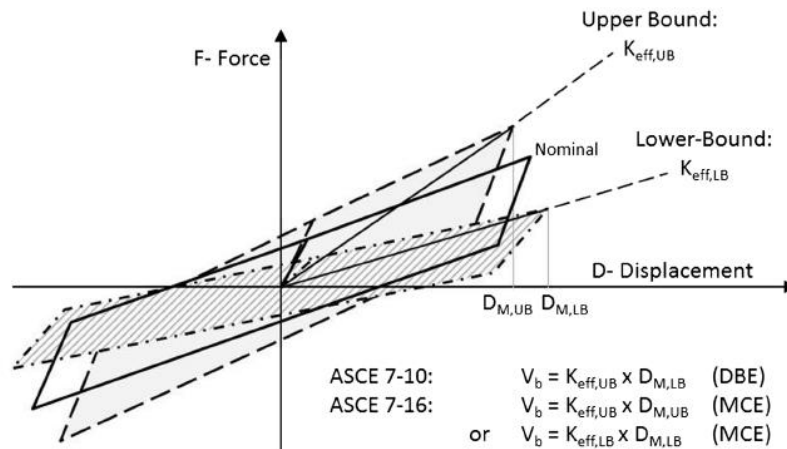

FIGURE C17.5-3 Nominal, Upper Bound, and Lower Bound Bilinear Hysteretic Properties of Typical Isolator Bearing

A comparison of the old elastic design base shears for a range of isolation system design parameters and lambda factors using the ASCE 7-10 provisions and those using these new provisions is shown in Table C17.5-1. This comparison assumes that the DE is $2/3$ the MCE_R and the longer period portion of both spectra decay as S_1/T . Table C17.5-1 shows a comparison between elastic design base shear calculated

using the ASCE/SEI 7-10 and 7-16 editions for a range of yield levels, second slopes, and bounding property multipliers.

Table C17.5-1 Comparison of Elastic Design Base Shears between ASCE 7-10 and 7-16

	Upper Bound Multipliers			K_d	Yield Level	Lower Bound Multipliers			K_d	Yield Level
MCE_R $S_1 = 1.5$				1.15	1.6				0.85	0.85
T_2 (s)	2.00	2.00	3.00	3.00	4.00	4.00	5.00	5	6	6
Yield Level	0.05	0.10	0.05	0.10	0.05	0.10	0.05	0.1	0.05	0.1
New, V_b / W	0.80	0.66	0.47	0.42	0.33	0.33	0.26	0.28	0.21	0.26
ASCE 7-16/ASCE 7-10	1.14	1.02	1.08	0.91	1.02	0.84	0.96	0.83	0.91	0.82
		1.0	1.6		1.0	0.85				
New, V_b / W	0.77	0.71	0.52	0.42	0.35	0.31	0.26	0.27	0.21	0.25
ASCE 7-16/ASCE 7-10	1.32	1.25	1.39	1.01	1.25	0.88	1.24	1.02	1.16	1.12
MCE_R $S_1 = 1.0$		1.15	1.6		0.85	0.85				
T_2 (s)	2.00	2.00	3.00	3.00	4.00	4.00	5.00	5	6	6
Yield Level	0.05	0.10	0.05	0.10	0.05	0.10	0.05	0.1	0.05	0.1
New, V_b / W	0.47	0.43	0.29	0.30	0.21	0.23	0.17	0.23	0.15	0.21
ASCE 7-16/ASCE 7-10	1.08	0.91	0.99	0.83	0.91	0.65	0.84	0.76	0.84	0.71
		1.35	1.5		0.85	0.85				
New, V_b / W	0.54	0.47	0.33	0.32	0.24	0.29	0.19	0.22	0.16	0.20

ASCE 7-16/ASCE 7-10	1.12	0.99	1.05	0.90	0.99	0.92	0.94	0.82	0.90	0.81
		1.3	1.3		0.85	0.85				
New, V_b / W	0.55	0.47	0.33	0.31	0.24	0.24	0.18	0.20	0.15	0.18
ASCE 7-16/ASCE 7-10	1.22	1.10	1.16	1.01	1.10	0.94	1.05	0.91	1.01	0.89

Note: Dark gray cells indicate that the new elastic design base shears are more than 10% higher than the old provisions; light gray cells indicate 0–10% higher than old provisions.

The dark gray cells in Table C17.5-1 indicate that the new elastic design base shears are more than 10% higher than the old provisions; the light gray cells indicate that the new elastic base shears are 0 to 10% higher than the old provisions; and the white cells indicate that the new elastic base shears are less than the old provisions.

C17.5.4.1 Isolation System and Structural Elements below the Base Level.

The provisions of this section are revised to reflect the MCE_R -only basis for design and associated changes in terminology. A new paragraph was added to this section to clarify that unreduced lateral loads should be used to determine overturning forces on the isolation system.

C17.5.4.2 Structural Elements above the Base Level.

The provisions of this section are revised to reflect the MCE_R -only basis for design and associated changes in terminology, including the new concept of the “base level” as the first floor immediately above the isolation system.

An exception has been added to allow values of R_f to exceed the current limit of 2.0, provided that the pushover strength of the superstructure at the MCE_R drift or $0.015h_{sx}$ story drift exceeds (by 10%) the maximum MCE_R force at the isolation interface (V_b). This exception directly addresses required strength and associated limits on inelastic displacement for MCE_R demands. The pushover method is addressed in ASCE 41 (2007).

A new formula (Eq. (17.5-7)) now defines lateral force on elements above the base level in terms of reduced seismic weight (seismic weight excluding the base level), and the effective damping of the isolation system, based on recent work (York and Ryan 2008). In this formulation, it is assumed that the base level is located immediately (within 3.0 ft (0.9m) of top of isolator) above the isolation interface. When the base level is not located immediately above the isolation interface (e.g., there is no floor slab just above the isolators), the full (unreduced) seismic weight of the structure above the isolation interface is used in Eq. (17.5-7) to conservatively define lateral forces on elements above the base level.

C17.5.4.3 Limits on V_s .

The provisions of this section are revised to reflect the MCE_R -only basis for design and associated changes in terminology.

In Section 17.5.4.3, the limits given on V_s are revised to clarify that the force required to fully activate the isolation system should be based on either the upper bound force-deflection properties of the isolation

system or 1.5 times nominal properties, whichever is greater. Other limits include (a) the yield/friction level to fully activate the isolation system and (b) the ultimate capacity of a sacrificial wind-restraint system that is intended to fail and release the superstructure during significant lateral load.

These limits are needed so that the superstructure does not yield prematurely before the isolation system has been activated and significantly displaced.

C17.5.5 Vertical Distribution of Force.

The provisions of this section are revised to incorporate a more accurate distribution of shear over height considering the period of the superstructure and the effective damping of the isolation system. The specified method for vertical distribution of forces calculates the force at the base level immediately above the base isolation plane, then distributes the remainder of the base shear among the levels above. That is, the mass of the “base slab” above the isolators is not included in the vertical distribution of forces.

The proposed revision to the vertical force distribution is based on recent analytical studies (York and Ryan 2008 in collaboration with Structural Engineers Association of Northern California’s Protective Systems Subcommittee PSSC). Linear theory of base isolation predicts that base shear is uniformly distributed over the height of the building, while the equivalent lateral force procedure of ASCE 7-10 prescribes a distribution of lateral forces that increase linearly with increasing height. The uniform distribution is consistent with the first mode shape of an isolated building, and the linear distribution is consistent with the first mode shape of a fixed-base building. However, a linear distribution may be overly conservative for an isolated building structure, especially for one- or two-story buildings with heavy base mass relative to the roof.

The principle established in the York and Ryan (2008) study was to develop two independent equations: one to predict the superstructure base shear V_{st} relative to the base shear across the isolators V_b , and a second to distribute V_{st} over the height of the building. Considering a reduction in V_{st} relative to V_b allowed for the often significant inertial forces at the base level, which can be amplified because of disproportionate mass at the base level, to be accounted for in design. The study also assumed that the superstructure base shear was distributed over the height using a ‘ K ’ distribution (i.e., lateral force $\propto W_x h_x^k$ where W_x is the weight and h_x the height to level x), where $k=0$ is a uniform distribution and $k=1$ is a linear distribution. In the study, representative base-isolated multistory single-bay frame models were developed, and response history analysis was performed with a suite of 20 motions scaled to a target spectrum corresponding to the effective isolation system parameters. Regression analysis was performed to develop a best fit (relative to median results from response history analysis) of the superstructure to base shear ratio and k factor as a function of system parameters. The equations recommended in York and Ryan (2008) provided the best “goodness of fit” among several considered, with R^2 values exceeding 0.95. Note that Eqs. (17.5-8) and (17.5-11) in the code change are the same as Eqs. (15) and (17) in York and Ryan (2008), with one modification: the coefficient for k in Eq. (17.5-11) has been modified to reflect that the reference plane for determining height should be taken as the plane of isolation, which is below the isolated base slab.

It is difficult to confirm in advance whether the upper bound or lower bound isolation system response will govern the design of the isolation system and structure. It is possible, and even likely, that the distribution corresponding to upper bound isolation system properties will govern the design of one portion of the structure, and the lower bound distribution will govern another. For example, lower bound isolation system response may produce a higher displacement, D_M , a lower damping, β_M , but also a higher base shear, V_b . This difference could result in a vertical force distribution that governs for the lower stories of the building. The corresponding upper bound case, with lower displacement, D_M , but higher damping, β_M , might govern design of the upper part of the structure, even though the base shear, V_b , is lower.

The proposal to adopt the approach in York and Ryan (2008) is part of an overall revamp that will permit the equivalent static force method to be extended to a wider class of buildings. In York and Ryan (2008), the current method was shown to be quite conservative for systems with low to medium levels of damping combined with stiff superstructures but unconservative for highly damped systems or systems with relatively flexible superstructures.

The proposal has undergone a high level of scrutiny by the code committee. First, regression analysis was performed using the original York and Ryan (2008) response history data set to fit several alternative distributions suggested by code committee members that were intuitively more appealing. In all cases, the equations recommended in York and Ryan (2008) were shown to best fit the data. Second, a few code committee members appropriately attempted to validate the equations using independently generated response history analysis data sets. Much discussion ensued following the discovery that the equations were unconservative for a class of one- and two-story buildings with long isolation periods and high levels of effective damping in the isolation system. This was most noticeable for one- and two-story buildings, i.e., with relatively low W_{st}/W ratios, predominantly single-mode fixed-base response, and where T_{fb} aligned with the period based on the initial stiffness of the isolation system, T_{k1} . The York and Ryan (2008) data set was confirmed to contain similar cases to those generated independently, and the unconservatism was rationalized as a natural outcome of the regression approach. In an attempt to remove the unconservatism, equations were fit to the 84th percentile (median $+1\sigma$) vertical force distributions based on the original York and Ryan (2008) data set. However, the resulting distributions were unacceptably conservative and thus rejected.

The York and Ryan (2008) data set was subsequently expanded to broaden the range of fixed-base periods for low-rise structures and to provide additional confirmation of the independent data set. In addition, isolation system hysteresis loop shape was identified as the most significant factor in the degree of higher mode participation, resulting in increased V_{st}/V_b ratio and k factor. The provisions now identify this variable as needing a more conservative k factor.

When computing the vertical force distribution using the equivalent linear force procedure, the provisions now divide isolation systems into two broad categories according to the shape of the hysteresis loop. Systems that have an abrupt transition between preyield and postyield response (or preslip and postslip for friction systems) are described as “strongly bilinear” and have been found to typically have higher superstructure accelerations and forces. Systems with a gradual or multistage transition between pre- and postyield response are described as “weakly bilinear” and were observed to have relatively lower superstructure accelerations and forces, at least for systems that fall within the historically adopted range of system strength/friction values (nominal isolation system force at zero displacement, $F_o = 0.03 \times W$ to $0.07 \times W$).

This limitation is acceptable because isolation systems with strength levels that fall significantly outside the upper end of this range are likely to have upper bound properties that do not meet the limitations of Section 17.4.1, unless the postyield stiffness or hazard level is high. Care should also be taken when using the equations to assess the performance of isolation systems at lower hazard levels because the equivalent damping can increase beyond the range of applicability of the original work.

Additional description of the two hysteresis loop types are provided in Table C17.5-2. An example of a theoretical loop for each system type is shown in Figure C17.5-4.

Table C17.5-2 Comparison of “Strongly Bilinear” and “Weakly Bilinear” Isolation Systems

System Type and Equation Term ^a	Pre- to Postyield Transition Characteristics	Cyclic Behavior Below Bilinear Yield/Slip Deformation	Example of Hysteresis Loop Shape	Example Systems ^b
“Strongly bilinear” ($1 - 3.5\beta_M$)	Abrupt transition from preyield or preslip to postyield or postslip	Essentially linear elastic, with little energy dissipation	Figure C17.5-4a	Flat sliding isolators with rigid backing Single-concave FPS Double-concave FPS with same friction coefficients top and bottom
“Weakly bilinear” ($1 - 2.5\beta_M$)	Smooth or multistage transition from preyield or preslip to postyield or postslip	Exhibits energy dissipation caused by yielding or initial low-level friction stage slip	Figure C17.5-4b	Elastomeric and viscous dampers Triple-concave FPS High-damping rubber Lead-rubber Elastomeric-backed sliders

^aEquation term refers to the exponent in Eq. (17.5-11).

^bFPS is friction pendulum system.

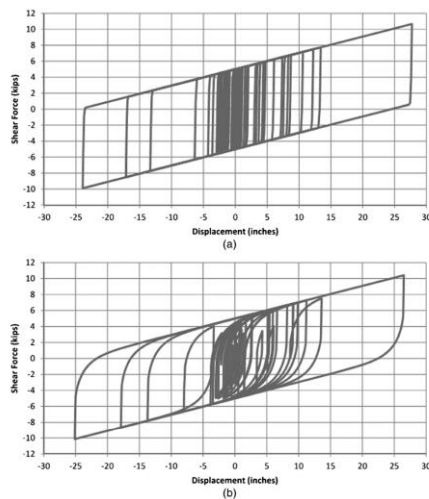

FIGURE C17.5-4 Example Isolation System Example Loops

Capturing this acceleration and force increase in the equivalent linear force procedure requires an increase in the V_{st} / V_b ratio (Eq. (17.5-7)) and the vertical force distribution k factor (Eq. (17.5-11)). Consequently, the provisions require a different exponent to be used in Eq. (17.5-7) for a system that

exhibits “strongly bilinear” behavior. Similar differences were observed in the k factor (Eq. (17.5-11)), but these findings were judged to be insufficiently well developed to include in the provisions at this time, and the more conservative value for “strongly bilinear” systems was adopted for both system types.

The exception in Section 17.5.5 is a tool to address the issue identified in the one- and two-story buildings on a project-specific basis and to simplify the design of seismically isolated structures by eliminating the need to perform time-consuming and complex response history analysis of complete 3D building models each time the design is changed. At the beginning of the project, a response history analysis of a simplified building model (e.g., a stick model on isolators) is used to establish a custom inertia force distribution for the project. The analysis of the 3D building model can then be accomplished using simple static analysis techniques.

The limitations on use of the equivalent linear force procedure (Section 17.4.1) and on the response spectrum analysis procedure (Section 17.4.2.1) provide some additional limits. Item 7a in Section 17.4.1 requires a minimum restoring force, which effectively limits postyield stiffness to $K_d > F_o / D_M$ and also limits effective damping to 32% for a bilinear system.

Items 2 and 3 in Section 17.4.1 limit the effective period, $T_M \leq 4.5$ s and effective damping, $\beta_M \leq 30\%$ explicitly.

C17.5.6 Drift Limits.

Drift limits are divided by C_d / R for fixed-base structures since displacements calculated for lateral loads reduced by R are multiplied by C_d before checking drift. The C_d term is used throughout the standard for fixed-base structures to approximate the ratio of actual earthquake response to response calculated for reduced forces. Generally, C_d is 1/2 to 4/5 the value of R . For isolated structures, the R_f factor is used both to reduce lateral loads and to increase displacements (calculated for reduced lateral loads) before checking drift. Equivalency would be obtained if the drift limits for both fixed-base and isolated structures were based on their respective R factors. It may be noted that the drift limits for isolated structures generally are more conservative than those for conventional, fixed-base structures, even where fixed-base structures are assigned to Risk Category IV. The maximum story drift permitted for design of isolated structures is constant for all risk categories.

C17.6 DYNAMIC ANALYSIS PROCEDURES

This section specifies the requirements and limits for dynamic procedures.

A more detailed or refined study can be performed in accordance with the analysis procedures described in this section, compatible with the minimum requirements of Section 17.5. Reasons for performing a more refined study include

1. The importance of the building.
2. The need to analyze possible structure-isolation system interaction where the fixed-base period of the building is greater than one-third of the isolated period.
3. The need to explicitly model the deformational characteristics of the lateral force-resisting system where the structure above the isolation system is irregular.
4. The desirability of using site-specific ground motion data, especially for very soft or liquefiable soils (Site Class F) or for structures located where S_1 is greater than 0.60.
5. The desirability of explicitly modeling the deformational characteristics of the isolation system. This point is especially important for systems that have damping characteristics that are amplitude-dependent, rather than velocity-dependent, because it is difficult to determine an appropriate value of equivalent viscous damping for these systems.

Where response history analysis is used as the basis for design, the design displacement of the isolation system and design forces in elements of the structure above are computed from the average of seven pairs of ground motion, each selected and scaled in accordance with Section 17.3.2.

The provisions permit a 10% reduction of V_b below the isolation system and 20% reduction of V_b for the structure above the isolators if the structure is of regular configuration. The displacement reduction should not be greater than 20% if a dynamic analysis is performed.

In order to avoid the need to perform a large number of nonlinear response history analyses that include the suites of ground motions, the upper and lower bound isolator properties, and five or more locations of the center of mass, this provision allows the center-of-mass analysis results to be scaled and used to account for the effects of mass eccentricity in different building quadrants.

The following is a recommended method of developing appropriate amplification factors for deformations and forces for use with center-of-mass nonlinear response history analyses (NRHAs) which account for the effects of accidental torsion. The use of other rationally developed amplification factors is permitted.

The most critical directions for shifting the calculated center of mass are such that the accidental eccentricity adds to the inherent eccentricity in each orthogonal direction at each level. For each of these two eccentric mass positions, and with lower bound isolator properties, the suite of NRHA analyses should be run and the results processed in accordance with Section 17.6.3.4. The analysis cases are defined in Table C17.6-1.

Table C17.6-1 Analysis Cases for Establishing Amplification Factors

Case	Isolator Properties	Accidental Eccentricity
I	Lower bound	No
IIa	Lower bound	Yes, X direction
IIb	Lower bound	Yes, Y direction

The results from Cases IIa and IIb are then compared in turn to those from Case I. The following amplification factors (ratio of Case IIa or IIb response to Case I response) are computed:

1. The amplification of isolator displacement at the plan location with the largest isolator displacement;
2. The amplification of story drift in the structure at the plan location with the highest drift, enveloped over all stories;
3. The amplification of frame-line shear forces at each story for the frame subjected to the maximum drift.

The larger of the two resulting scalars on isolator displacement should be used as the displacement amplification factor; the larger of the two resulting scalars on drift should be used as the deformation amplification factor; and the larger of the two resulting scalars on force should be used as the force amplification factor. Once the amplification factors are established, the effects of accidental eccentricity should be considered as follows.

The nonlinear response history analysis procedure should be carried out for the inherent mass eccentricity case only, considering both upper and lower bound isolator properties. For each isolator property variation, response quantities should be computed in accordance with Section 17.6.3.4. All resulting isolator displacements should be increased by the displacement amplification factor, all resulting deformation response quantities should be increased by the deformation amplification factor, and all resulting force quantities should be increased by the force amplification before being used for evaluation or design.

The procedure for scaling of dynamic analysis results to the ELF-based minima described in Section 17.6.4.3 is slightly different for response spectrum versus response history analysis. The reason for this difference is that it is necessary to create a consistent basis of comparison between the dynamic response quantities and the ELF-based minima (which are based on the maximum direction). When response spectrum analysis is performed, the isolator displacement, base shear, and story shear at any level used for comparison with the ELF-based minima already correspond to a single, maximum direction of excitation. Thus, the vector sum of the 100%/30% directional combination rule (as described in Section 17.6.3.3) need not be used. Note, however, that while the 100%/30% directional combination rule is not required in scaling response spectrum analysis results to the ELF-based minima of Section 17.6.4.3, the 100%/30% directional combination rule is still required for design of the superstructure by response spectrum analysis, per Section 17.6.3.3. When nonlinear response history analysis is performed, the isolator displacement and base shear for each ground motion is calculated as the maximum of the vector sum of the two orthogonal components (of displacement or base shear) at each time step. The average of the maxima over all ground motions of these displacement and base shear vector-sum values is then used for comparison with the ELF-based minimum displacement and base shear per Section 17.6.4.3.

C17.6.2 Modeling.

Capturing the vertical response of a building structure with a high degree of confidence may be a challenging task. Nonetheless, when the effects of vertical shaking are to be included in the analysis and/or design process of an isolated building structure, the following modeling recommendations are provided:

1. Vertical mass: All beams, columns, shear walls, and slabs should be included in the model, and the vertical mass should be distributed appropriately across the footprint of each floor.
2. Foundation properties: A range of soil properties and foundation damping should be considered in the analysis procedure since horizontal and vertical ground motion excitation can significantly affect building response.
3. Soil–foundation–structure interaction effects: Foundation damping, embedment, and base slab averaging may alter the vertical motions imparted on the structure as compared to the free-field motions.
4. Degrees of freedom: Additional degrees of freedom (e.g., nodes along the span of a beam or slab) will need to be added to the model to capture vertical effects.
5. Reduced time step: Since vertical ground motion excitation and building response often occur at higher frequencies than lateral excitation and response, a finer analysis time step might be required when vertical motions are included.

C17.6.3.4 Response History Analysis Procedure.

For sites identified as near-fault, each pair of horizontal ground motion components shall be rotated to the fault-normal and fault-parallel directions of the causative faults and applied to the building in such orientation.

For all other sites, each pair of horizontal ground motion components shall be applied to the building at orthogonal orientations such that the mean of the component response spectra for the records applied in each direction is approximately equal ($\pm 10\%$) to the mean of the component response spectra of all records applied for the period range specified in Section 17.3.3. Peer review would be the judge of “approximately equal.”

C17.7 DESIGN REVIEW

The provisions allow for a single peer reviewer to evaluate the isolation system design. The reviewer should be a registered design professional (RDP), and if the engineer of record (EOR) is required to be a structural engineer (SE), the owner may consider ensuring that there is one SE on the peer review team. On more significant structures, it is likely that the design review panel may include two or three individuals, but for many isolated structures, a single, well-qualified peer reviewer is sufficient. If a manufacturer with unknown experience in the United States is selected as the supplier, the building owner may require the design reviewer to attend prototype tests.

The standard requires peer review to be performed by registered design professionals who are independent of the design team and other project contractors. The reviewer or review panel should include individuals with special expertise in one or more aspects of the design, analysis, and implementation of seismic isolation systems.

The peer reviewer or review panel should be identified before the development of design criteria (including site-specific ground-shaking criteria) and isolation system design options. Furthermore, the review panel should have full access to all pertinent information and the cooperation of the general design team and regulatory agencies involved in the project.

C17.8 TESTING

The design displacements and forces determined using the standard assume that the deformational characteristics of the isolation system have been defined previously by comprehensive testing. If comprehensive test data are not available for a system, major design alterations in the structure may be necessary after the tests are complete. This change would result from variations in the isolation system properties assumed for design and those obtained by test. Therefore, it is advisable that prototype tests of systems be conducted during the early phases of design if sufficient prototype test data are not available from a given manufacturer.

The design displacements and forces determined using the standard are based on the assumption that the deformational characteristics of the isolation system have been defined previously by comprehensive qualification and prototype testing. Variations in isolator properties are addressed by the use of property variation factors that account for expected variation in isolator and isolation system properties from the assumed nominal values. In practice, past prototype test data are very likely to have been used to develop the estimated nominal values and associated lambda factors used in the design process, as described in Section 17.2.8.4.

When prototype testing is performed in accordance with Section 17.8.2, it serves to validate and check the assumed nominal properties and property variation factors used in the design. Where project-specific prototype testing is not performed, it is possible to perform a subset of the checks described below on the isolator unit and isolation system test properties using data from the quality control test program, described in Section 17.8.5.

C17.8.2.2 Sequence and Cycles.

Section 17.2.8.4 describes the method by which minimum and maximum isolator properties for design and analysis are established using property variation or lambda (λ) factors to account for effects such as specification tolerance, cyclic degradation, and aging. The structural analysis is therefore performed twice, and the resulting demands are enveloped for design. For force-based design parameters and procedures, this requirement is relatively straightforward, as typically one case or the other governs, primarily, but not always, the upper bound. However, for components dependent on both force and deformation, e.g., the isolators, there exist two sets of axial load and displacement values for each required test. Lower bound properties typically result in larger displacements and smaller axial loads, whereas upper bound properties typically result in smaller displacements and larger axial loads. To avoid requiring that a complete set of

duplicate tests be performed for the lower and upper bound conditions, Section 17.8.2.2 requires the results to be enveloped, combining the larger axial demands from one case with the larger displacements from the other. Strictly, these demands and displacement do not occur simultaneously, but the enveloping process is conservative.

The enveloping process typically results in test axial loads that correspond to the maximum properties and displacements that correspond to minimum properties. Hence, the test results determined using the enveloped demands may not directly relate to the design properties or analysis results determined for maximum and minimum properties separately. However, since the test demands envelop the performance range for the project, the registered design professional is able to use them to determine appropriate properties for both linear and nonlinear analysis using the same philosophy as provided here.

Two alternate testing protocols are included in Section 17.8.2.2. The traditional three-cycle tests are preserved in Item 2(a) for consistency with past provisions. These tests can be performed dynamically but have often been performed at slow speed consistent with the capability of manufacturers' testing equipment. The alternate test sequence provided in Item 2(b) is more suited to full-scale dynamic cyclic testing.

The Item (3) test displacement has been changed from D_D to D_M , reflecting the focus of the provisions on only the MCE_R event. Since this test is common to both test sequences 2(a) and 2(b), it becomes important for property determination. This is the only test required to be repeated at different axial loads when isolators are also axial load-carrying elements, which is typically the case. This change was made to counter the criticism that the total test sequence of past provisions represented the equivalent energy input of many MCE_R events back to back and that prototype test programs could not be completed in a reasonable time if any provision for isolator cooling and recovery was included.

The current test program is therefore more reflective of code-minimum required testing. The RDP and/or the isolator manufacturer may wish to perform additional testing to more accurately characterize the isolator for a wider range of axial loads and displacements than is provided here. For example, this might include performing the Item 2(b) dynamic test at additional axial loads once the code-required sequence is complete.

Heat effects for some systems may become significant, and misleading, if insufficient cooling time is included between adjacent tests. As a consequence, in test sequence 4 only five cycles of continuous dynamic testing are required as this is a limit of most test equipment. The first-cycle or scragging effects observed in some isolators may recover with time, so back-to-back testing may result in an underestimation of these effects. Refer to Constantinou et al. (2007) and Kalpakidis and Constantinou (2008) for additional information. The impact of this behavior may be mitigated by basing cyclic lambda factors on tests performed relatively early in the sequence before these effects become significant.

C17.8.2.3 Dynamic Testing.

Section 17.8.2.3 clarifies when dynamic testing is required. Many common isolator types exhibit velocity dependence, however, this testing can be expensive and can only be performed by a limited number of test facilities. The intent is not that dynamic testing of isolators be performed for every project. Sufficient dynamic test data must be available to characterize the cyclic performance of the isolator, in particular the change in isolator properties during the test, i.e., with respect to the test average value. Dynamic testing must therefore be used to establish the $\lambda_{(test,min)}$ and $\lambda_{(test,max)}$ values used in Section 17.2.8.4, since these values are typically underestimated from slow-speed test data. If project prototype or production testing is to be performed at slow speeds, this testing would also be used to establish factors that account for the effect of velocity and heating on the test average values of k_{eff} , k_d , and E_{loop} . These factors can either

be thought of as a separate set of velocity-correction factors to be applied on test average values, or they can be incorporated into the $\lambda_{(\text{test},\text{min})}$ and $\lambda_{(\text{test},\text{max})}$ values themselves.

It may also be possible to modify the isolator mathematical model, for example, to capture some or all of the isolator velocity dependence, e.g., the change in yield level of the lead core in a lead rubber bearing (LRB).

If project-specific prototype testing is undertaken, it may be necessary to adjust the test sequence in recognition of the capacity limitations of the test equipment, and this notion is now explicitly recognized in Section 17.8.2.2. For example, tests that simultaneously combine maximum velocity and maximum displacement may exceed the capacity of the test equipment and may also not be reflective of earthquake shaking characteristics. A more detailed examination of analysis results may be required to determine the maximum expected velocity corresponding to the various test deformation levels and to establish appropriate values for tests.

Refer to Constantinou et al. (2007) for additional information.

C17.8.2.4 Units Dependent on Bilateral Load.

All types of isolators have bilateral load dependence to some degree. The mathematical models used in the structural analysis may include some or all of the bilateral load characteristics for the particular isolator type under consideration. If not, it may be necessary to examine prototype test data to establish the impact on the isolator force-deformation response as a result of the expected bilateral loading demands. A bounding approach using lambda (λ) factors is one method of addressing bilateral load effects that cannot be readily incorporated in the isolator mathematical model.

Bilateral isolator testing is complex, and only a few test facilities are capable of performing these tests. Project-specific bilateral load testing has not typically been performed for isolation projects completed to date. In lieu of performing project-specific testing, less restrictive similarity requirements may be considered by the registered design professional compared to those required for test data submitted to satisfy similarity for Sections 17.8.2.2 and 17.8.2.5. Refer to Constantinou et al. (2007) for additional information.

C17.8.2.5 Maximum and Minimum Vertical Load.

The exception to Section 17.8.2.5 permits that the tests may be performed twice, once with demands resulting from upper bound properties and once with lower bound properties. This option may be preferable for these isolator tests performed at D_{TM} since the isolator will be closer to its ultimate capacity.

C17.8.2.7 Testing Similar Units.

Section 17.8.2.7 now provides specific limits related to the acceptability of data from testing of similar isolators. A wider range of acceptability is permitted for dynamic test data.

1. The submitted test data should demonstrate the manufacturers' ability to successfully produce isolators that are comparable in size to the project prototypes, for the relevant dimensional parameters, and to test them under force and displacement demands equal to or comparable to those required for the project.
2. It is preferred that the submitted test data necessary to satisfy the registered design professional and design review be for as few different isolator types and test programs as possible. Nonetheless, it may be necessary to consider data for isolator A to satisfy one aspect of the required project prototype test program, and data from isolator B for another.
3. For more complex types of testing, it may be necessary to accept a wider variation of isolator dimension or test demands than for tests that more fundamentally establish the isolator nominal

operating characteristics, e.g., the testing required to characterize the isolator for loading rate dependence (Section 17.8.2.3) and bilateral load dependence (Section 17.8.2.4).

4. The registered design professional is not expected to examine quality control procedures in detail to determine whether the proposed isolators were manufactured using sufficiently similar methods and materials. Rather, it is the responsibility of the manufacturer to document the specific differences, if any, preferably via traceable quality control documentation and to substantiate that any variations are not significant.
5. In some cases, the manufacturer may not wish to divulge proprietary information regarding methods of isolator fabrication, materials, or quality control procedures. These concerns may or may not be alleviated by confidentiality agreements or other means to limit the distribution and publication of sensitive material. Regardless, the final acceptability of the test information of similar units is at the sole discretion of the registered design professional and the design review, and not the manufacturer.
6. Similarity can be especially problematic in a competitive bid situation, when successful selection may hinge on the success of one supplier in eliminating the need to fabricate and test project-specific prototype isolators. This requirement can be addressed by determining acceptability of similarity data before bid or by including more detailed similarity acceptance provisions in the bid documentation than have been provided herein.

Refer to Constantinou et al. (2007) and Shenton (1996) for additional information.

C17.8.3 Determination of Force-Deflection Characteristics.

The method of determining the isolator effective stiffness and effective damping ratio is specified in Eqs. (17.8-1) and (17.8-2). Explicit direction is provided for establishment of effective stiffness and effective damping ratio for each cycle of test. A procedure is also provided for fitting a bilinear loop to a given test cycle, or to an average test loop to determine the postyield stiffness, k_d . This process can be performed several different ways; however, the fitted bilinear loop should also match effective stiffness and energy dissipated per cycle from the test. Once k_d is established, the other properties of the bilinear loop (e.g., f_y , f_o) all follow from the bilinear model.

Depending on the isolator type and the degree of sophistication of the isolator hysteresis loop adopted in the analysis, additional parameters may also be calculated, such as different friction coefficients, tangent stiffness values, or trilinear loop properties.

These parameters are used to develop a mathematical model of the isolator test hysteresis that replicates, as near as possible, the observed test response for a given test cycle. The model should result in a very close match to the effective stiffness and effective damping ratio and should result in a good visual fit to the hysteresis loop with respect to the additional parameters. The mathematic loop model must, at a minimum, match the effective stiffness and loop area from the test within the degree of variation adopted within the $\lambda_{(\text{spec},\text{min})}$ to $\lambda_{(\text{spec},\text{max})}$ range.

Data from the first cycle (or half cycle) of testing is not usually representative of full-cycle behavior and is typically discarded by manufacturers during data processing. An additional cycle (or half cycle) is added at the end to provide the required number of test cycles from which data can be extracted. However, the first cycle of a test is often important when establishing upper bound isolator properties and should be included when determining the $\lambda_{(\text{test},\text{min})}$ and $\lambda_{(\text{test},\text{max})}$ factors. The form of the test loop, however, is different to that of a full-scale loop, particularly for multistage isolator systems such as the double- or triple-concave friction pendulum system. This form may require different hysteresis parameters to be considered than the ones described by the bilinear model in Figure 17.8-1. The provisions permit the use of different methods for

fitting the loop, such as a straight-line fit of k_d directly to the hysteresis curve extending to D_M and then determining k_1 to match E_{loop} , or an alternate is defining D_y and F_y by visual fit and then determining k_d to match E_{loop} .

The effective stiffness and effective damping ratio are required in linear static and linear response spectrum analysis. However, even if a nonlinear response history analysis is performed, these parameters are still required to check the required minimum lateral displacements and lateral forces of Sections 17.5.3 and 17.5.4, respectively.

C17.8.4 Test Specimen Adequacy.

For each isolator type, the effective stiffness and effective damping ratio for a given test axial load, test displacement, and cycle of test are determined in accordance with Section 17.8.3. For the dynamic test sequence in Item 2(a) in Section 17.8.2.2, there are two cycles at each increment of test displacement; for the traditional slow-speed sequence, there are three.

However, as part of a seismic isolation system, the axial load on a given isolator varies during a single complete cycle of loading. The required range of variation is assumed to be defined by the test load combinations required in Section 17.2.4.6, and the appropriate properties for analysis are assumed to be the average of the properties at the three axial loads. The test performed for Item (3) in Section 17.8.2.2 is critical to this evaluation since it is the three-cycle test performed at all three axial loads common to both the dynamic and slow-speed sequence.

In addition, since all isolators must undergo the same total horizontal cyclic loading as part of the same system, it is therefore assumed to be appropriate to assemble the total seismic isolation system properties using the following sequence:

1. Average the test results for a given isolator and cycle of loading across the three test axial loads. Also compute corresponding test lambda factors for each isolator type.
2. Sum up the total isolation system properties for each cycle of loading according to the number of isolators of each type.
3. Determine the maximum and minimum values of total system effective stiffness over the required three cycles of testing and the corresponding values of the effective damping ratio. Also compute the test lambda factors for the overall isolation system.

Two sets of test lambda factors emerge from this process, those applicable to individual isolators determined in (1) and those applicable to the overall isolation system properties determined in (3). In general, the test lambda factors for individual isolator tests are similar to those for each isolator type, which are similar to that for the overall isolation system. If this is the case, it may be more convenient to simplify the lambda factors assumed during design to reflect reasonable envelope values to be applied to all isolator types.

However, if the test lambda factors that emerge from project-specific prototype testing differ significantly from those assumed during design, it may be helpful to build up the system properties as described above, since the unexpectedly high test lambda factors for one isolator type may be offset by test lambda factors for another isolator type that were lower than the assumed values. In this circumstance, the prototype test results may be considered acceptable, provided that the torsional behavior of the system is not significantly affected and that the isolator connection and adjacent members can accommodate any resulting increase in local force demands.

Also, note that a subset of the isolation system properties can be determined from quality assessment and quality control (production) testing. This testing is typically performed at an axial load corresponding to the average $D+0.5L$ axial load for the isolator type and to a displacement equal to $2/3(D_M)$. Keep in mind

that isolator properties with target nominal three-cycle values estimated to match the average test value across three axial loads may not exactly match the values from production testing at the average dead load.

This result is most commonly observed with effective stiffness and effective damping ratio values for friction-based isolators since the average of the three test axial loads required in Section 17.8.2.2 does not exactly match that present in the isolator during the lateral analysis (the seismic weight, typically $1.0 \times$ Dead Load). In this case, some additional adjustment of properties may be required. Once the test effective stiffness and effective damping ratio of the isolation system have been established, these are compared to the values assumed for design in Section 17.2.8.4, defined by the nominal values and the values of $\lambda_{(\text{test,max})}$ and $\lambda_{(\text{test,min})}$.

In practice, instead of performing prototype tests for direct use in analysis, it may be simpler to use prototype test data or data from acceptable past testing of similar units (see Section 17.8.2.7) to establish isolator property dependence relationships for such things as axial load or velocity. If relationships are established for applicable hysteresis-loop parameters, such as yield force, friction ratio, initial stiffness, and postyield stiffness, these can be used to generate the required isolator unit and isolation system effective stiffness and effective damping ratios for the project over the required operating range.

C17.8.5 Production Tests.

The number of production isolation units to be tested in combined compression and shear is 100%. Both quasi-static and dynamic tests are acceptable for all types of isolators. If a quasi-static test is used, it must have been performed as a part of the prototype tests. The registered design professional (RDP) is responsible for defining in the project specifications the scope of the manufacturing quality control test program. The RDP decides on the acceptable range of variations in the measured properties of the production isolation units. All (100%) of the isolators of a given type and size are tested in combined compression and shear, and the allowable variation of the mean should be within the specified tolerance of Section 17.2.8.4 (typically $\pm 10\%$ or $\pm 15\%$). Individual isolators may be permitted a wider variation ($\pm 15\%$ or $\pm 20\%$) from the nominal design properties. For example, the mean of the characteristic strength, Q , for all tested isolators might be permitted to vary no more than $\pm 10\%$ from the specified value of Q , but the characteristic strength for any individual isolation unit might be permitted to vary no more than $\pm 15\%$ from the specified value of Q . Another commonly specified allowable range of deviation from specified properties is $\pm 15\%$ for the mean value of all tested isolation units, and $\pm 20\%$ for any single isolation unit.

The combined compression and shear testing of the isolators reveals the most relevant characteristics of the completed isolation unit and permits the RDP to verify that the production isolation units provide load-deflection behavior that is consistent with the structural design assumptions. Although vertical load-deflection tests have sometimes been specified in quality control testing programs, these test data are typically of little value. Consideration should be given to the overall cost and schedule effects of performing multiple types of quality control tests, and only those tests that are directly relevant to verifying the design properties of the isolation units should be specified.

Where project-specific prototype testing in accordance with Section 17.8.2 is not performed, the production test program should evaluate the performance of each isolator unit type for the property variation effects from Section 17.2.8.4.

REFERENCES

- American Association of State Highway and Transportation Officials (AASHTO). (1990). *Guide specifications for seismic isolation design*. AASHTO, Washington, DC.
- AASHTO. (1999). *Guide specifications for seismic isolation design*. American Association of State Highway and Transportation Officials, Washington, DC.

- ANSI/American Institute of Steel Construction (AISC). “Seismic provisions for structural steel buildings.” *ANSI/AISC 341*, Chicago.
- ASCE. (2007). “Seismic rehabilitation of existing buildings.” *ASCE/SEI41- 06*, ASCE, Reston, VA.
- ASTM International. (2012). “Standard specification for plain and steellaminated elastomeric bearings for bridges.” *D4014*. ASTM International, West Conshohocken, PA.
- Buckle, I. G., Nagarajaiah, S, Ferrel, K. (2002). “Stability of elastomeric isolation bearings: Experimental study.” *ASCE J. Struct. Eng.* 128, 3–11. Constantinou, M. C., Kalpakidis, I., Filiatrault, A., and Ecker Lay, R. A. (2011). “LRFD-based analysis and design procedures for bridge bearings and seismic isolators.” *Report No. MCEER-11-0004*, Multidisciplinary Center for Earthquake Engineering Research, Buffalo, NY.
- Constantinou, M. C., Tsopelas, P., Kasalanati, A., and Wolff, E. D. (1999). “Property modification factors for seismic isolation bearings.” *MCEER-99- 0012*, Multidisciplinary Center for Earthquake Engineering Research, Buffalo, NY.
- Constantinou, M. C., Whittaker, A. S., Kalpakidis, Y., Fenz, D. M., and Warn, G. P. (2007). “Performance of seismic isolation hardware under service and seismic loading.” *MCEER-07-0012*, Multidisciplinary Center for Earthquake Engineering Research, Buffalo, NY.
- Constantinou, M. C., Winters, C. W., and Theodossiou, D. (1993). “Evaluation of SEAOC and UBC analysis procedures. Part 2: Flexible superstructure.” Proc., Seminar on Seismic Isolation, Passive Energy Dissipation and Active Control, *ATC Report 17-1*. Applied Technology Council, Redwood City, CA.
- Federal Emergency Management Agency (FEMA). (1999). *HAZUS software*. Federal Emergency Management Agency, Washington, DC.
- FEMA. (2003). NEHRP recommended seismic provisions for new buildings and other structures, Federal Emergency Management Agency, Washington, DC.
- FEMA. (2009a). *Quantification of building seismic performance factors*. P-695. Federal Emergency Management Agency, Washington, DC.
- FEMA. (2009b). NEHRP recommended seismic provisions for new buildings and other structures, Federal Emergency Management Agency, Washington, DC.
- FEMA. (2012). *Seismic performance assessment of buildings*. P-58. Federal Emergency Management Agency, Washington, DC.
- International Council of Building Officials (ICBO). (1991). *Uniform building code*, Whither, CA.
- Kalpakidis, I. V., and Constantinou, M. C. (2008). “Effects of heating and load history on the behavior of lead-rubber bearings,” *MCEER-08-0027*, Multidisciplinary Center for Earthquake Engineering Research, Buffalo, NY.
- Kalpakidis, I. V., and Constantinou, M. C. (2009). “Effects of heating on the behavior of lead-rubber bearings. I: Theory.” *J. Struct. Eng.*, 135(12), 1440-1449.
- Kalpakidis, I. V., Constantinou, M. C., and Whittaker, A. S. (2010). “Modeling strength degradation in lead-rubber bearings under earthquake shaking,” *Earthq. Eng. Struct. Dyn.* 39(13), 1533-1549.

- Katsaras, A. (2008). "Evaluation of current code requirements for displacement restoring capability of seismic isolation systems and proposals for revisions." *Project No. GOCE-CT-2003-505488*, LessLoss Project cofounded by European Commission with 6th Framework.
- Kelly, J. M., and Chaloub, M. S. (1990). "Earthquake simulator testing of a combined sliding bearing and rubber bearing isolation system." *Report No. UCB/EERC-87/04*, University of California, Berkeley.
- Kelly, J. M., and Hodder, S. B. (1981). "Experimental study of lead and elastomeric dampers for base isolation systems." *Report No. UCB/EERC- 81/16*, University of California, Berkeley.
- Kelly, J. M., and Konstantinidis, D. A. (2011). *History of multi-layered rubber bearings*. John Wiley and Sons, New York.
- Kelly, J. M., Skinner, M. S., Beucke, K. E. (1980). "Experimental testing of an energy absorbing seismic isolation system." *Report No. UCB/EERC-80/ 35*, University of California, Berkeley.
- Kircher, C. A., Lashkari, B., Mayes, R. L., and Kelly, T. E. (1988). *Evaluation of nonlinear response in seismically isolated buildings*. Proc., Symposium on Seismic, Shock and Vibration Isolation, ASME Pressure Vessels and Piping Conference, New York.
- Masroor, A., and Mosqueda, G. (2015). "Assessing the Collapse Probability of Base-Isolated Buildings Considering Pounding to Moat Walls Using the FEMA P695 Methodology." *Earthq. Spectra* 31(4), 2069-2086.
- McVitty, W., and Constantinou, M.C. (2015). "Property Modifications factors for Seismic Isolators: Design guidance for buildings." *MCEER Report No. 000-2015*.
- National Institute of Standards and Technology (NIST). (2011). "Selecting and scaling earthquake ground motions for performing response-history analyses," *GCR 11-917-15*, National Institute of Standards and Technology, Gaithersburg, MD.
- Ryan, K. L., Coria, C. B., Dao, N. D., (2012). "Large scale earthquake simulation for hybrid lead rubber isolation system designed with consideration for nuclear seismicity." *U.S. Nuclear Regulatory Commission CCEER 13-09*.
- Shenton, H. W., III., (1996). Guidelines for pre-qualification, prototype, and quality control testing of seismic isolation systems, *NISTIR 5800*.
- York, K., and Ryan, K. (2008). "Distribution of lateral forces in base-isolated buildings considering isolation system nonlinearity." *J. Earthq. Eng.*, 12, 1185-1204.
- Zayas, V., Low, S., and Mahin, S. (1987). "The FPS earthquake resisting system." *Report No. UCB/EERC-87-01*; University of California, Berkeley.

OTHER REFERENCES (NOT CITED)

- Applied Technology Council. (ATC). (1982). "An investigation of the correlation between earthquake ground motion and building performance." *ATC Report 10*. ATC, Redwood City, CA.
- Lashkari, B., and Kircher, C. A. (1993). *Evaluation of SEAOC and UBC analysis procedures. Part I: Stiff superstructure*. Proc., Seminar on seismic isolation, passive energy dissipation and active control. Applied Technology Council, Redwood City, CA.

Warn, G. P., and Whittaker, A. W. (2006). "Performance estimates in seismically isolated bridge structures." *Eng. Struct.*, 26, 1261-1278.

Warn, G. P., and Whittaker, A. S. (2004). "Performance estimates in seismically isolated bridge structures." *Eng. Struct.* 26, 1261-1278.

Page intentionally left blank.

COMMENTARY TO CHAPTER 18, SEISMIC DESIGN REQUIREMENTS FOR STRUCTURES WITH DAMPING SYSTEMS

C18.1 GENERAL

The requirements of this chapter apply to all types of damping systems, including both displacement-dependent damping devices of hysteretic or friction systems and velocity-dependent damping devices of viscous or viscoelastic systems (Soong and Dargush 1997, Constantinou et al. 1998, Hanson and Soong 2001). Compliance with these requirements is intended to produce performance comparable to that for a structure with a conventional seismic force-resisting system, but the same methods can be used to achieve higher performance.

The damping system (DS) is defined separately from the seismic force-resisting system (SFRS), although the two systems may have common elements. As illustrated in Figure C18.1-1, the DS may be external or internal to the structure and may have no shared elements, some shared elements, or all elements in common with the SFRS. Elements common to the DS and the SFRS must be designed for a combination of the loads of the two systems. When the DS and SFRS have no common elements, the damper forces must be collected and transferred to members of the SFRS.

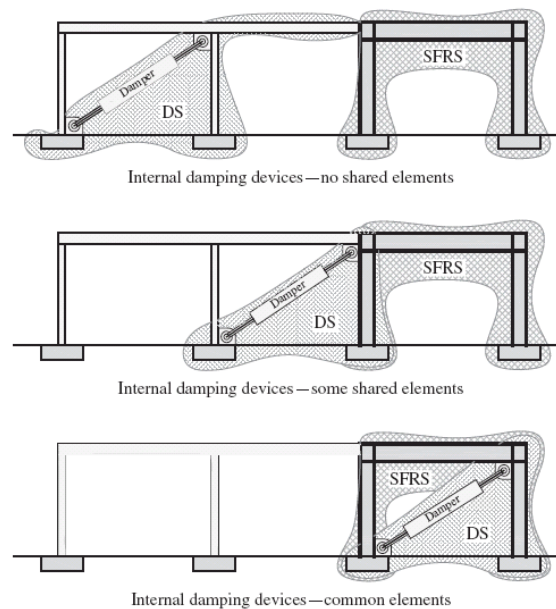

FIGURE C18.1-1 Damping System (DS) and Seismic Force-Resisting System (SFRS) Configurations

C18.2 GENERAL DESIGN REQUIREMENTS

C18.2.1 System Requirements.

Structures with a DS must have an SFRS that provides a complete load path. The SFRS must comply with all of the height, Seismic Design Category, and redundancy limitations and with the detailing requirements specified in this standard for the specific SFRS. The SFRS without the damping system (as if damping devices were disconnected) must be designed to have not less than 75% of the strength required for structures without a DS that have that type of SFRS (and not less than 100% if the structure is horizontally or vertically irregular). The damping systems, however, may be used to meet the drift limits (whether the structure is regular or irregular). Having the SFRS designed for a minimum of 75% of the strength required

for structures without a DS provides safety in the event of damping system malfunction and produces a composite system with sufficient stiffness and strength to have controlled lateral displacement response.

The analysis and design of the SFRS under the base shear, V_{\min} , from Eqs. (18.2-1) or (18.2-2) or, if the exception applies, under the unreduced base shear, V , should be based on a model of the SFRS that excludes the damping system.

C18.2.1.2 Damping System.

The DS must be designed for the actual (unreduced) MCE_R forces (such as peak force occurring in damping devices) and deflections. For certain elements of the DS (such as the connections or the members into which the damping devices frame), other than damping devices, limited yielding is permitted provided that such behavior does not affect damping system function or exceed the amount permitted for elements of conventional structures by the standard.

Furthermore, force-controlled actions in elements of the DS must consider seismic forces that are 1.2 times the computed average MCE_R response. Note that this increase is applied for each *element action*, rather than for each *element*. Force-controlled actions are associated with brittle failure modes where inelastic deformation capacity cannot be ensured. The 20% increase in seismic force for these actions is required to safeguard against undesirable behavior.

C18.2.2 Seismic Ground Motion Criteria

It is likely that many projects incorporating a supplemental damping system simply use design earthquake (DE) and MCE_R spectra based on the mapped values referenced in Chapter 11. Site-specific spectra are always permitted and must be used for structures on Site Class F.

When nonlinear response history analysis is used, ground motions are selected, scaled or matched and applied in accordance with the procedures of Chapter 16, with the exception that a minimum of 7 rather than 11 ground motions are required. The use of 7 motions is consistent with current practice for design of code-compliant structures, and 7 is considered an adequate number to estimate the mean response for a given hazard level. No other provisions of Chapter 16 apply to structures incorporating supplemental damping systems.

C18.2.3 Procedure Selection.

The nonlinear response history procedure for structures incorporating supplemental damping systems is the preferred procedure, and Chapter 18 is structured accordingly. This method, consistent with the majority of current practice, provides the most realistic predictions of the seismic response of the combined SFRS and DS. If the nonlinear response history procedure is adopted, the relevant sections of Chapter 18 are 18.1 through 18.6.

However, via the exception, response spectrum (RS) and equivalent lateral force (ELF) analysis methods can be used for design of structures with damping systems that meet certain configuration and other limiting criteria (for example, at least two damping devices at each story configured to resist torsion). In such cases, additional nonlinear response history analysis is used to confirm peak responses when the structure is located at a site with S_1 greater than or equal to 0.6. The analysis methods of damped structures are based on nonlinear static “pushover” characterization of the structure and calculation of peak response using effective (secant) stiffness and effective damping properties of the first (pushover) mode in the direction of interest. These concepts are used in Chapter 17 to characterize the force-deflection properties of isolation systems, modified to incorporate explicitly the effects of ductility demand (post-yield response) and higher mode response of structures with dampers. Similar to conventional structures, damped structures generally

yield during strong ground shaking, and their performance can be influenced strongly by response of higher modes.

The RS and ELF procedures presented in Chapter 18 have several simplifications and limits, outlined as follows:

1. A multiple-degree-of-freedom (MDOF) structure with a damping system can be transformed into equivalent single-degree-of-freedom (SDOF) systems using modal decomposition procedures. This procedure assumes that the collapse mechanism for the structure is an SDOF mechanism so that the drift distribution over height can be estimated reasonably using either the first mode shape or another profile, such as an inverted triangle. Such procedures do not strictly apply to either yielding buildings or buildings that are nonproportionally damped.
2. The response of an inelastic SDOF system can be estimated using equivalent linear properties and a 5% damped response spectrum. Spectra for damping greater than 5% can be established using damping coefficients, and velocity-dependent forces can be established either by using the pseudovelocity and modal information or by applying correction factors to the pseudovelocity.
3. The nonlinear response of the structure can be represented by a bilinear hysteretic relationship with zero postelastic stiffness (elastoplastic behavior).
4. The yield strength of the structure can be estimated either by performing simple plastic analysis or by using the specified minimum seismic base shear and values of R , Ω_0 , and C_d .
5. Higher modes need to be considered in the equivalent lateral force procedure to capture their effects on velocity-dependent forces. This requirement is reflected in the residual mode procedure.

FEMA 440 (2005) presents a review of simplified procedures for the analysis of yielding structures. The combined effects of the simplifications mentioned above are reported by Ramirez et al. (2001) and Pavlou and Constantinou (2004) based on studies of three-story and six-story buildings with damping systems designed by the procedures of the standard. The RS and ELF procedures of the standard are found to provide conservative predictions of drift and predictions of damper forces and member actions that are of acceptable accuracy when compared to results of nonlinear dynamic response history analysis. When designed in accordance with the standard, structures with damping systems are expected to have structural performance at least as good as that of structures without damping systems. Pavlou and Constantinou (2006) report that structures with damping systems designed in accordance with the standard provide the benefit of reduced secondary system response, although this benefit is restricted to systems with added viscous damping.

If either the RS or ELF procedures are adopted, the relevant sections of Chapter 18 are Sections 18.1, 18.2, 18.5, 18.6, and 18.7.

C18.2.4.1 Device Design.

Damping devices may operate on a variety of principles and may use materials that affect their short-term and long-term performance. This commentary provides guidance on the behavior of some of these devices in order to justify the language in the standard and in order to assist the engineer in deciding on the upper and lower bound values of mechanical properties of the devices for use in analysis and design.

Damping devices that have found applications or have potential for application may be classified as follows:

1. Fluid viscous dampers (or oil dampers) that operate on the principle of orificing of fluid, typically some form of oil (Constantinou et al. 2007). These devices are typically highly engineered and precision made so that their properties are known within a narrow range. That is, when the devices are tested, their properties show small variability. One issue is heating that may have significant effects (Makris et al. 1998), which can be alleviated or eliminated by using accumulators or by using materials with varying thermal expansion properties so that the orifice size is automatically adjusted with varying temperature.
 - However, their long-term behavior may be affected by a variety of potential problems:

-
- a. Devices using accumulators include valves that may fail over time depending on the quality of construction and history of operation. It is not possible to know if and when a valve may fail.
 - b. Fluid is maintained in the device by seals between the body and the moving piston of the device, which may leak either as a result of wear caused by excessive cumulative travel or poor construction. For buildings, excessive cumulative travel is rarely an issue. When seals leak, the output of the device reduces, depending on the reduction of internal pressure of the device. It is recommended that potential leakage of oil not be considered in establishing lower bound values of property modification factors (as it is not possible to know) but rather a periodic inspection and maintenance program recommended by the manufacturer be used to detect problems and make corrections.
 - c. Orifices may be very small in diameter and therefore may result in clogging when impure oil is used or the oil is contaminated by particles of rubber used in the sealing of fluid in poorly constructed devices or by metal particles resulting from internal corrosion or because of oil cavitation when poor-quality materials are used. Typically, rubber should not be used in sealing and parts should be threaded rather than welded or connected by posttensioning. Larger diameter orifices should be preferred.
2. Viscoelastic fluid or solid devices. These devices operate on the principle of shearing of highly viscous fluids or viscoelastic solids. These viscous fluids and viscoelastic solids have a strong dependence of properties on frequency and temperature. These effects should be assessed by qualification testing. Their long-term behavior is determined by the behavior of the fluid or solid used, both of which are expected to harden with time. The engineer should ask the supplier for data on the aging of the material based on observations in real time. Information based on accelerated aging is not useful and should not be used (Constantinou et al. 2007).
 3. Metallic yielding devices. Yielding steel devices are typically manufactured of steel with yield properties that are known within a narrow range. Nevertheless, the range of values of the yield strength can be determined with simple material tests. Also, testing some of the devices should be used to verify the information obtained in coupon testing. Aging is of least concern because corrosion may only slightly reduce the section geometrical properties. An inspection and maintenance program should eliminate the concern for aging.
 4. Friction devices. Friction devices operate on the principle of preloaded sliding interfaces. There are two issues with such devices:
 - a. The preload may reduce over time because of creep in sliding interface materials or the preloading arrangement, or wear in the sliding interface when there is substantial service-load related motion or after high-speed seismic motion. It is not possible to know what the preload may be within the lifetime of the structure, but the loss may be minimized when high-strength bolts are used and high-strength/low-wear materials are used for the sliding interface.
 - b. The friction coefficient at the sliding interface may substantially change over time. The engineer is directed to Constantinou et al. (2007) for a presentation on the nature of friction and the short-term and long-term behavior of some sliding interfaces. In general, reliable and predictable results in the long-term friction may be obtained when the sliding interface consists of a highly polished metal (typically stainless steel) in contact with a nonmetallic softer material that is loaded to high pressure under confined conditions so that creep is completed in a short time. However, such interfaces also result in low friction (and thus are typically used in sliding isolation bearings). The engineer is referred to Chapter 17 and the related commentary for such cases. Desirable high friction (from a performance standpoint) may be obtained by use of metal to metal sliding interfaces. However, some of these interfaces are absolutely unreliable because they promote severe additional corrosion and they should never be used (British Standards Institution 1983). Other bimetallic interfaces have the tendency to form solid solutions or intermetallic compounds with one
-

another when in contact without motion. This tendency leads to cold welding (very high adhesion or very high friction). Such materials are identified by compatibility charts (Rabinowicz 1995). The original Rabinowicz charts categorized pairs of metals as incompatible (low adhesion) to compatible and identical (high adhesion). Based on that characterization, identical metals and most bimetallic interfaces should be excluded from consideration in sliding interfaces. Excluding interfaces that include lead (too soft), molybdenum, silver, and gold (too expensive), only interfaces of tin–chromium, cadmium–aluminum, and copper–chromium are likely to have low adhesion. Of these, the tin–chromium interface has problems of additional corrosion (British Standards Institution 1983) and should not be used. Accordingly, only bimetallic interfaces of cadmium–aluminum and copper–chromium may be useful. The materials in these interfaces have similar hardness so that creep-related effects are expected to be important, leading to increased true area of contact and increased friction force over time (Constantinou et al. 2007). This increase leads to the conclusion that all bimetallic interfaces result in significant changes in friction force over time that are not possible to predict, and therefore these types of interfaces should not be used.

5. Lead extrusion devices. These devices operate on the principle of extruding lead through an orifice. The behavior of the device is dependent on the rate of loading and temperature, and its force output reduces with increasing cycling because of heating effects. These effects can be quantified by testing so that the nominal properties and property modification factors can be established. Leakage of lead during the lifetime of the device is possible during operation and provided that the seals fail, although the effects cannot be expected to be significant. Leakage is preventable by use of proven sealing technologies and by qualification testing to verify (Skinner et al. 1993).

The registered design professional (RDP) must define the ambient temperature and the design temperature range. The ambient temperature is defined as the normal in-service temperature of the damping device. For devices installed in interior spaces, this temperature may be taken as 70°F, and the design temperature range could come from the project mechanical engineer. For devices installed exposed to exterior temperature variation, the ambient temperature may be taken as the annual average temperature at the site, and the design temperature range may be taken as the annual minimum and maximum temperatures. Since the design temperature range is implicitly tied to MCE_R analysis through λ factors for temperature, the use of maximum and minimum temperatures over the design life of the structure are considered too severe.

C18.2.4.4 Nominal Design Properties.

Device manufacturers typically supply nominal design properties that are reasonably accurate based on previous prototype test programs. The nominal properties can be confirmed by project-specific prototype tests during either the design or construction phases of the project.

C18.2.4.5 Maximum and Minimum Damper Properties Specification Tolerance on Nominal Design Properties.

As part of the design process, it is important to recognize that there are variations in the production damper properties from the nominal properties. This difference is caused by manufacturing variation. Recommended values for the specification tolerance on the average properties of all devices of a given type and size are typically in the $\pm 10\%$ to $\pm 15\%$ range. For a $\pm 10\%$ specification tolerance, the corresponding λ factors would be $\lambda_{(\text{spec,max})} = 1.1$ and $\lambda_{(\text{spec,min})} = 0.9$. Variations λ for individual device properties may be greater than the tolerance on the average properties of all devices of a given type and size. It is recommended that the device manufacturer be consulted when establishing these tolerance values.

Property Variation (λ) Factors and Maximum and Minimum Damper Properties. Section 18.2.4.5 requires the devices to be analyzed and designed with consideration given to environmental conditions,

including the effects of aging, creep, fatigue, and operating temperatures. The individual aging and environmental factors are multiplied together, and then the portion of the resulting λ factor (λ_{ae}) differing from unity is reduced by 0.75 based on the assumption that not all of the maximum/minimum aging and environmental values occur simultaneously.

Results of prototype tests may also indicate the need to address device behavior whereby tested properties differ from the nominal design properties because of test-related effects. Such behavior may include velocity effects, first cycle effects, and any other testing effects that cause behavior different from the nominal design properties. This behavior is addressed through a testing λ factor (λ_{test}), which is a multiple of all the individual testing effects.

The specification (λ_{spec}), environmental (λ_{ae}) and testing (λ_{test}) factors are used to establish maximum (λ_{max}) and minimum (λ_{min}) damper properties for each device type and size for use in mathematical models of the damped structure in accordance with Eqs. (18.2-3a) and (18.2-3b). These factors are typically applied to whatever parameters govern the mathematical representation of the device.

It should be noted that more sophisticated mathematical models account for various property variation effects directly (e.g., velocity or temperature). When such models are used, the cumulative effect of the λ factors reduce (become closer to 1.0) since some of the typical behaviors contributing to λ_{max} and λ_{min} are already included explicitly in the model. Some effects, such as specification tolerance and aging, will likely always remain since they cannot be accounted for in mathematical models.

Example

Data from prototype testing, as defined in Section 18.6.1, are used to illustrate the λ factors and the maximum and minimum values to be used in analysis and design. The fluid viscous damper under consideration has the following nominal force-velocity constitutive relationship, with kips and inch units:

$$F = C \operatorname{sgn}(V) |V|^\alpha = 128 \operatorname{sgn}(v) |V|^{0.38}$$

The solid line in Figure C18.2-1 depicts the nominal force-displacement relationship.

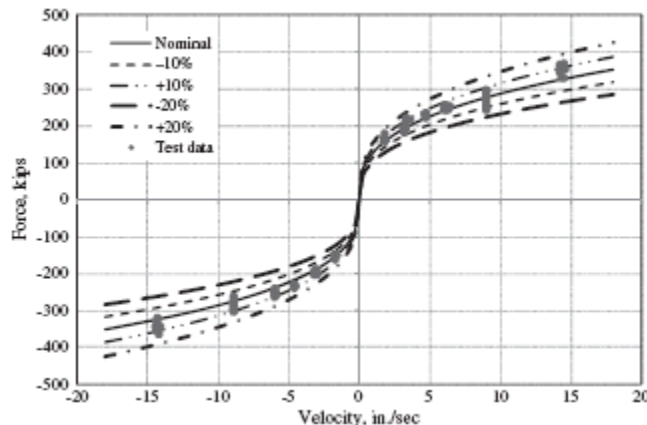

FIGURE C18.2-1 Force-Velocity Relationship for a Nonlinear Viscous Damper

Prototype tests of damper corresponding to the following conditions were conducted:

- Force-velocity characteristic tests, all conducted at ambient temperature of 70°F.
 - 10 full cycles performed at various amplitudes.

- Temperature tests, three fully reversible cycles conducted at various velocities at the following temperatures:
 - 40°F
 - 70°F
 - 100°F

The data from prototype tests for each cycle (maximum and negative) are shown as data points in Figure C18.2-1.

Also shown in the Figure are the variations from nominal in the force-velocity relationships for this damper. The relationships are obtained by changing the damper constant (C) value. No variation is considered for the velocity exponent, α . The following diagrams are shown:

- A pair of lines corresponding to damper nominal constitutive relationship computed with the C value increased or decreased by 10%. These lines account for the λ_{test} factors as defined in Section 18.2.5.4: , $\lambda_{(\text{test},\text{min})} = 0.9$.
- For these particular devices, the variation in properties caused by aging and environmental factors is taken as $\pm 5\%$ ($\lambda_{(ae,\text{max})} = 1.05$, $\lambda_{(ae,\text{min})} = 0.95$), and the specification tolerance is set at $\pm 5\%$ ($\lambda_{(\text{spec},\text{max})} = 1.05$, $\lambda_{(\text{spec},\text{min})} = 0.95$). These values should be developed in conjunction with the device manufacturer based on their history of production damper test data and experience with aging and other environmental effects. Using these values in Eqs. (18.2-3a) and (18.2-3b) results in $\lambda_{\text{max}} = 1.20$ and $\lambda_{\text{min}} = 0.82$. These values satisfy the minimum variation requirements of Section 18.2.4.5. They are rounded to $\lambda_{\text{max}} = 1.2$ and $\lambda_{\text{min}} = 0.8$.
- A pair of lines corresponding to the cumulative maximum and minimum λ values (accounting for testing, specification tolerance, and other factors listed in Section 18.2.4.5) computed with the nominal C value increased or decreased by 20%.

For this example, analysis with minimum and maximum damper properties should be conducted by using 80% and 120% of the nominal value for C , respectively. The analysis with maximum damper properties typically produces larger damper forces for use in the design of members and connections, whereas the analysis with minimum damper properties typically produces less total energy dissipation and hence larger drifts.

C18.2.4.6 Damping System Redundancy.

This provision is intended to discourage the use of damping systems with low redundancy in any story. At least four damping devices should be provided in each principal direction, with at least two devices in each direction on each side of the center of stiffness to control torsional response. In cases where there is low damping system redundancy by this definition, all damping devices in all stories must be capable of sustaining increased displacements (with associated forces) and increased velocities (with associated displacements and forces) relative to a system with adequate redundancy. The penalty is 130%.

C18.3 NONLINEAR RESPONSE HISTORY PROCEDURE

Those elements of the SFRS and the DS that respond essentially elastically at MCE_R (based on a limit of 1.5 times the expected strength calculated using $\phi = 1$) are permitted to be modeled elastically. Modeling parameters and acceptance criteria provided in ASCE 41, with a performance objective defined in Table 2.2, as modified in this chapter, are deemed satisfactory to meet the requirements of this section.

The hardware of all damping devices (for example, the cylinder of a piston-type device) and the connections between the damping devices and the remainder of the structure must remain elastic at MCE_R (see Section 18.2.1.2). The nonlinear behavior of all other elements of both the SFRS and the DS must be modeled based on test data, which must not be extrapolated beyond the tested deformations. Strength and stiffness degradation must be included if such behavior is indicated. However, the damping system must not become nonlinear to such an extent that its function is impaired.

Nonlinear response history analysis (NRHA) is performed at both the design earthquake (DE) and the MCE_R levels. Accidental eccentricity is included at MCE_R but need not be included at the DE level, since the SFRS design checks from Section 18.2.1.1 include accidental eccentricity. However, the results from the NRHA at DE using a model of the combined SFRS and DS must be used to recheck all elements of the SFRS, since the checks of Section 18.2.1.1 are conducted using a representation of the structure excluding the damping system. This requirement is defined in Section 18.4.1. The damping system is designed and evaluated based on the results of the MCE_R analyses, as defined in Section 18.4.2.

For sites classified as near-fault, individual pairs of horizontal ground motion components must be applied to the model to reflect the fault-normal and fault-parallel directions. For all other sites, each pair of horizontal ground motion components should be applied to the building at orthogonal orientations such that the mean of the component response spectra for the records applied in each direction is approximately equal (close to $\pm 10\%$) to the mean of the component response spectra of all records applied for the period range specified in Section 18.2.2.2. The design reviewer would be the judge of what constitutes “approximately equal.”

C18.3.2 Accidental Mass Eccentricity.

In order to avoid the need to perform a large number of nonlinear response history analyses that include the suites of ground motions, the upper and lower bound damper properties, and five or more locations of the center of mass, the exception in this provision allows the center-of-mass analysis results to be scaled and used to account for the effects of mass eccentricity in different building quadrants.

The following is one suggested method of developing appropriate amplification factors for deformations and forces for use with center-of-mass NRHAs to account for the effects of accidental eccentricity. The use of other rationally developed amplification factors is permitted and encouraged given that the artificial shift of the center of mass changes the dynamic characteristics of the analyzed structure and may lead to the paradox of reduced torsional response with increasing accidental eccentricity (Basu et al. 2014).

The most critical directions for moving the calculated center of mass are such that the accidental eccentricity adds to the inherent eccentricity in each orthogonal direction at each level. For each of these two eccentric mass positions, and with minimum damper properties, the suite of NRHAs should be run and the results processed in accordance with Section 18.3.3. The analysis cases are defined in Table C18.3-1.

Table C18.3-1 Analysis Cases for Establishing Amplification Factors

Case	Damper Properties	Accidental Eccentricity
I	Minimum	No
IIa	Minimum	Yes, <i>X</i> direction
IIb	Minimum	Yes, <i>Y</i> direction

The results from Cases IIa and IIb are then compared in turn to those from Case I. The following amplification factors (ratio of Case IIa or IIb response to Case I response) are computed:

- (a) The amplification for story drift in the structure at the plan location with the highest drift, enveloped over all stories;
- (b) The amplification for frame-line shear forces at each story for the frame subjected to the maximum drift.

The larger of the two resulting scalars on drift should be used as the deformation amplifier, and the larger of the two resulting scalars on force should be used as the force amplifier. Once the amplification factors are established, the effects of accidental eccentricity should be considered as follows.

The NRHA procedure should be run for the inherent mass eccentricity case only, considering both maximum and minimum damper properties. For each damper property variation, response quantities should be computed in accordance with Section 18.3.3. All resulting deformation response quantities should be increased by the deformation amplifier, and all resulting force quantities should be increased by the force amplifier before being used for evaluation or design.

C18.4 SEISMIC LOAD CONDITIONS AND ACCEPTANCE CRITERIA FOR NONLINEAR RESPONSE HISTORY PROCEDURE

C18.4.1 Seismic Force-Resisting System.

All elements of the SFRS are checked under two conditions. First, the SFRS (excluding the damping system) is checked under the minimum base shear requirements of Section 18.2.1.1. Second, the demands from the NRHA at DE (with a model of the combined SFRS and DS) must be used to recheck all elements of the SFRS.

There are three limiting values for the analytically computed drift ratios at . Table 12.12-1 lists the allowable drifts for structures. These limiting drift ratios are checked against drift ratio demands computed from the code procedure. Since the code design is an implied DE intensity, the drift ratios in the table are also intended to be used at analysis conducted at this level.

1. 3% limit: For most common structures, the DE allowable drift ratio (Δ_a / h) is 2%. Because for most cases, the ratio of MCE_R to DE intensity is 1.5, then the allowable drift ratio at MCE_R becomes 3% ($1.5 \times 2\%$).
2. 1.9 factor: When NRHA analysis is used, the code (Section 16.2.4.3 of ASCE 7-10) allows the DE drift ratios computed from analysis to be limited to 125% of the DE drift ratio limits of Table 12.12-1. Therefore, the MCE_R drift ratios are limited to 1.9 (approximately equal to 1.5×1.25) of limits of Table 12.12-1.
3. $1.5R/C_d$ factor: The deflections δ_x of Eq. (12.8-15) are computed by amplifying the deflections computed from analysis by the deflection amplification factor (C_d). The elastic deflections used in Chapter 12 themselves are computed at DE intensity using elastic analysis with forces that are reduced by the response modification factor, R . Thus, for the purpose of comparing drift ratios computed from NRHA with Table 12.12-1, the entries of the table need to be modified by the R/C_d factor for comparison at DE level. Therefore, the allowable drift ratios at MCE_R correspond to $1.5R/C_d$ of entries of the table.

Example: Five-Story Steel Special Moment Frames in Risk Category I or II

- Allowable drift ratio from Table 12.12-1 = 2%.
- Allowable drift ratio for structures with dampers using NRHA then would be the smallest of
 - 3%,
 - $1.9 \times 2\% = 3.8\%$, and
 - $1.5 \times (8 / 5.5) \times 2\% = 4.4\%$.
- 3% controls. Thus, all computed drift ratios from NRHA should be 3% or less at MCE_R .

C18.5 DESIGN REVIEW

The independent design review of many structures incorporating supplemental damping may be performed adequately by one registered and appropriately experienced design professional. However, for projects involving significant or critical structures, it is recommended that a design review panel consisting of two or three registered and appropriately experienced design professionals be used.

C18.6 TESTING**C18.6.1.2 Sequence and Cycles of Testing.**

The use of $1/(1.5T_1)$ as the testing frequency is based on a softening of the combined SFRS and DS associated with a system ductility of approximately 2. Test 2 (d) in Section 18.6.1.2 ensures that the prototype damper is tested at the maximum force from analysis.

It should be noted that velocity-dependent devices (for example, those devices characterized by $F = C_v^a$) are not intended to be characterized as frequency-dependent under item 4 of this section.

C18.6.1.3 Testing Similar Devices.

In order for existing prototype test data to be used to satisfy the requirement of Section 18.6.1, the conditions of this provision must be satisfied. It is imperative that identical manufacturing and quality control procedures be used for the preexisting prototype and the project-specific production damping devices. The precise interpretations of “similar dimensional characteristics, internal construction, and static and dynamic internal pressures” and “similar maximum strokes and forces” are left to the RDP and the design review team. However, variations in these characteristics of the preexisting prototype device beyond approximately $\pm 20\%$ from the corresponding project-specific values should be cause for concern.

C18.6.1.4 Determination of Force-Velocity-Displacement Characteristics.

When determining nominal properties (item 2) for damping devices whose first-cycle test properties differ significantly from the average properties of the first three cycles, an extra cycle may be added to the test, and the nominal properties may be determined from the average value using data from the second through fourth cycles. In this case, the effect of first-cycle properties must be addressed explicitly and included in the λ_{\max} factor. It should be noted that if the property variation methodology of Sections 18.2.4.4 and 18.2.4.5 is applied consistently, the maximum and minimum design properties (Eqs. (18.2-4a) and (18.2-4b)) will be identical, regardless of whether the nominal properties are taken from the average of cycles 1 through 3 or cycles 2 through 4.

C18.6.2 Production Tests.

The registered design professional is responsible for defining in the project specifications the scope of the production damper test program, including the allowable variation in the average measured properties of the production damping devices. The registered design professional must decide on the acceptable variation

of damper properties on a project-by-project basis. This range must agree with the specification tolerance from Section 18.2.4.5. The standard requires that all production devices of a given type and size be tested.

Individual devices may be permitted a wider variation (typically $\pm 15\%$ or $\pm 20\%$) from the nominal design properties. For example, in a device characterized by $F = C_v^a$, the mean of the force at a specified velocity for all tested devices might be permitted to vary no more than $\pm 10\%$ from the specified value of force, but the force at a specified velocity for any individual device might be permitted to vary no more than $\pm 15\%$ from the specified force.

The production dynamic cyclic test is identical (except for three versus five cycles) to one of the prototype tests of Section 18.6.1.2, so that direct comparison of production and prototype damper properties is possible.

The exception is intended to cover those devices that would undergo yielding or be otherwise damaged under the production test regime. The intent is that piston-type devices be 100% production tested, since their properties cannot be shown to meet the requirements of the project specifications without testing. For other types of damping devices, whose properties can be demonstrated to be in compliance with the project specifications by other means (for example, via material testing and a manufacturing quality control program), the dynamic cyclic testing of 100% of the devices is not required. However, in this case, the RDP must establish an alternative production test program to ensure the quality of the production devices. Such a program would typically focus on such things as manufacturing quality control procedures (identical between prototype and production devices), material testing of samples from a production run, welding procedures, and dimensional control. At least one production device must be tested at 0.67 times the MCE_R stroke at a frequency equal to $1/(1.5T_1)$, unless the complete project-specific prototype test program has been performed on an identical device. If such a test results in inelastic behavior in the device, or the device is otherwise damaged, that device cannot be used for construction.

C18.7 ALTERNATE PROCEDURES AND CORRESPONDING ACCEPTANCE CRITERIA

This section applies only to those cases where either the RS or the ELF procedure is adopted.

C18.7.1 Response-Spectrum Procedure and C18.7.2 Equivalent Lateral Force Procedure

Effective Damping. In the standard, the reduced response of a structure with a damping system is characterized by the damping coefficient, B , based on the effective damping, β , of the mode of interest. This approach is the same as that used for isolated structures. Like isolation, effective damping of the fundamental mode of a damped structure is based on the nonlinear force-deflection properties of the structure. For use with linear analysis methods, nonlinear properties of the structure are inferred from the overstrength factor, Ω_0 , and other terms.

Figure C18.7-1 illustrates reduction in design earthquake response of the fundamental mode caused by increased effective damping (represented by coefficient, B_{1D}). The capacity curve is a plot of the nonlinear behavior of the fundamental mode in spectral acceleration-displacement coordinates. The reduction caused by damping is applied at the effective period of the fundamental mode of vibration (based on the secant stiffness).

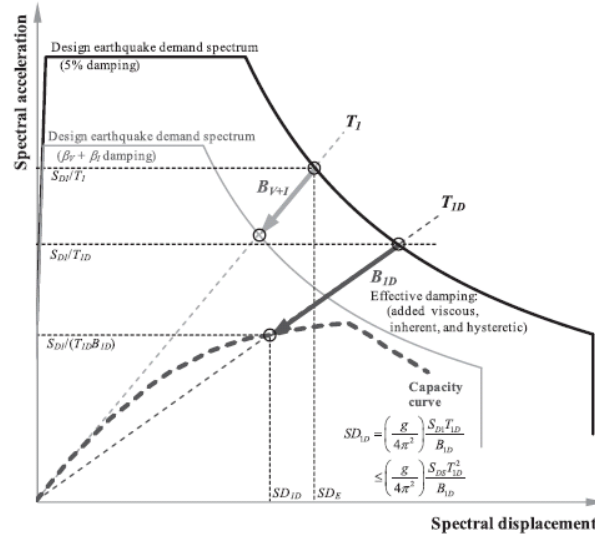

FIGURE C18.7-1 Effective Damping Reduction of Design Demand

In general, effective damping is a combination of three components:

1. Inherent Damping (β_I)—Inherent damping of the structure at or just below yield, excluding added viscous damping (typically assumed to be 2–5% of critical for structural systems without dampers).
2. Hysteretic Damping (β_H)—Postyield hysteretic damping of the seismic force-resisting system and elements of the damping system at the amplitude of interest (taken as 0% of critical at or below yield).
3. Added Viscous Damping (β_V)—The viscous component of the damping system (taken as 0% for hysteretic or friction-based damping systems).

Both hysteretic damping and added viscous damping are amplitude-dependent, and the relative contributions to total effective damping change with the amount of postyield response of the structure. For example, adding dampers to a structure decreases postyield displacement of the structure and, hence, decreases the amount of hysteretic damping provided by the seismic force-resisting system. If the displacements are reduced to the point of yield, the hysteretic component of effective damping is zero and the effective damping is equal to inherent damping plus added viscous damping. If there is no damping system (as in a conventional structure), effective damping simply equals inherent damping.

Linear Analysis Methods. The section specifies design earthquake displacements, velocities, and forces in terms of design earthquake spectral acceleration and modal properties. For equivalent lateral force (ELF) analysis, response is defined by two modes: the fundamental mode and the residual mode. The residual mode is used to approximate the combined effects of higher modes. Although typically of secondary importance to story drift, higher modes can be a significant contributor to story velocity and, hence, are important for design of velocity-dependent damping devices. For response spectrum analysis, higher modes are explicitly evaluated.

For both the ELF and the response spectrum analysis procedures, response in the fundamental mode in the direction of interest is based on assumed nonlinear (pushover) properties of the structure. Nonlinear (pushover) properties, expressed in terms of base shear and roof displacement, are related to building capacity, expressed in terms of spectral coordinates, using mass participation and other fundamental-mode factors shown in Figure C18.7-2. The conversion concepts and factors shown in Figure C18.7-2 are the

same as those defined in Chapter 9 of ASCE/SEI 41 (2014), which addresses seismic rehabilitation of a structure with damping devices.

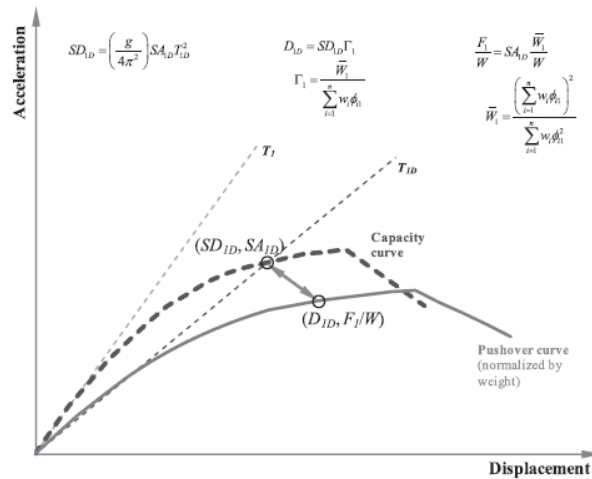

FIGURE C18.7-2 Pushover and Capacity Curves

Where using linear analysis methods, the shape of the fundamental-mode pushover curve is not known, so an idealized elastoplastic shape is assumed, as shown in Figure C18.7-3. The idealized pushover curve is intended to share a common point with the actual pushover curve at the design earthquake displacement, D_{1D} . The idealized curve permits definition of the global ductility demand caused by the design earthquake, μ_D , as the ratio of design displacement, D_{1D} , to yield displacement, D_Y . This ductility factor is used to calculate various design factors; it must not exceed the ductility capacity of the seismic force-resisting system, μ_{max} , which is calculated using factors for conventional structural response. Design examples using linear analysis methods have been developed and found to compare well with the results of nonlinear time history analysis (Ramirez et al. 2001).

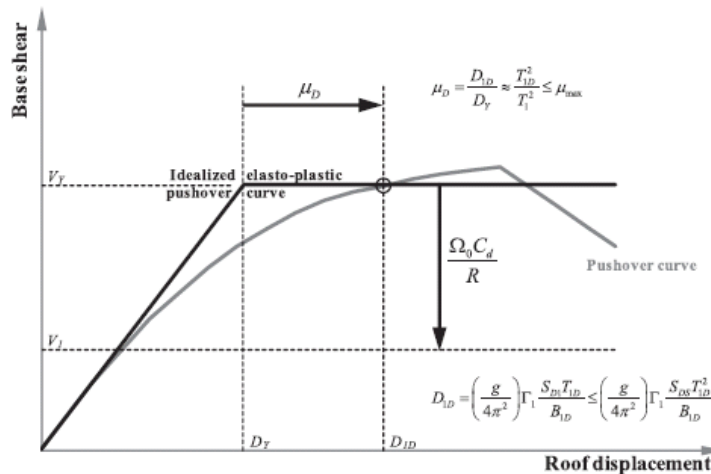

FIGURE C18.7-3 Pushover and Capacity Curves

Elements of the damping system are designed for fundamental-mode design earthquake forces corresponding to a base shear value of V_Y (except that damping devices are designed and prototypes are tested for maximum considered earthquake response). Elements of the seismic force-resisting system are

designed for reduced fundamental-mode base shear, V_1 , where force reduction is based on system overstrength (represented by Ω_0), multiplied by C_d/R for elastic analysis (where actual pushover strength is not known). Reduction using the ratio C_d/R is necessary because the standard provides values of C_d that are less than those for R . Where the two parameters have equal value and the structure is 5% damped under elastic conditions, no adjustment is necessary. Because the analysis methodology is based on calculating the actual story drifts and damping device displacements (rather than the displacements calculated for elastic conditions at the reduced base shear and then multiplied by C_d), an adjustment is needed. Because actual story drifts are calculated, the allowable story drift limits of Table 12.12-1 are multiplied by R/C_d before use.

C18.7.3 Damped Response Modification

C18.7.3.1 Damping Coefficient.

Values of the damping coefficient, B , in Table 18.7-1 for design of damped structures are the same as those in Table 17.5-1 for isolated structures at damping levels up to 20% but extend to higher damping levels based on results presented in Ramirez et al. (2001). Table C18.7-1 compares values of the damping coefficient as found in the standard and various resource documents and codes. FEMA 440 (2005) and Eurocode 8 (2005) present equations for the damping coefficient, B , whereas the other documents present values of B in tabular format.

Table C18.7-1 Values of Damping Coefficient,

Effective Damping, β (%)	Table 17.5-1 of ASCE/SEI 7 (2010), AASHTO (2010), CBC (2013), seismically isolated structures)	Table 18.6-1 of ASCE/SEI 7 (2010) (structures with damping systems)	FEMA 440 (2005)	Eurocode 8 (2005)
2	0.8	0.8	0.8	0.8
5	1.0	1.0	1.0	1.0
10	1.2	1.2	1.2	1.2
20	1.5	1.5	1.5	1.6
30	1.7	1.8	1.8	1.9
40	1.9	2.1	2.1	2.1
50	2.0	2.4	2.4	2.3

The equation in FEMA 440 is $B = \frac{4}{5.6 - \ln(100\beta)}$

The equation in Eurocode 8 (2005) is $B = \sqrt{\frac{0.05 + \beta}{0.10}}$

C18.7.3.2 Effective Damping.

The effective damping is calculated assuming that the structural system exhibits perfectly bilinear hysteretic behavior characterized by the effective ductility demand, μ , as described in Ramirez et al. (2001). Effective damping is adjusted using the hysteresis loop adjustment factor, q_H , which is the actual area of the hysteresis loop divided by the area of the assumed perfectly bilinear hysteretic loop. In general, values of this factor are less than unity. In Ramirez et al. (2001), expressions for this factor (which they call Quality Factor) are too complex to serve as a simple rule. Eq. (18.7-49) provides a simple estimate of this factor. The equation predicts correctly the trend in the constant acceleration domain of the response spectrum, and it is believed to be conservative for flexible structures.

C18.7.4 Seismic Load Conditions and Acceptance Criteria for RSA and ELF Procedures

C18.7.4.5 Seismic Load Conditions and Combination of Modal Responses.

Seismic design forces in elements of the damping system are calculated at three distinct stages: maximum displacement, maximum velocity, and maximum acceleration. All three stages need to be checked for structures with velocity-dependent damping systems. For displacement-dependent damping systems, the first and third stages are identical, whereas the second stage is inconsequential.

Force coefficients C_{mFD} and C_{mFV} are used to combine the effects of forces calculated at the stages of maximum displacement and maximum velocity to obtain the forces at maximum acceleration. The coefficients are presented in tabular form based on analytic expressions presented in Ramirez et al. (2001) and account for nonlinear viscous behavior and inelastic structural system behavior.

REFERENCES

- American Association of State Highway and Transportation Officials (AASHTO). (2010). *Guide specifications for seismic isolation design*, Washington, DC.
- ASCE/SEI. (2014), "Seismic evaluation and retrofit of existing buildings." *ASCE/SEI 41-13*, Reston, VA.
- Basu, D., Constantinou, M. C., and Whittaker, A. S. (2014). "An equivalent accidental eccentricity to account for the effects of torsional ground motion on structures." *Eng. Struct.*, 69, 1–11.
- British Standards Institution. (1983). "Commentary on corrosion at bimetallic contacts and its alleviation," *PD6484:1979*, London.
- California Buildings Standards Commission (CBC). (2013). *California building code*. Sacramento, CA.
- Constantinou, M. C., Soong, T. T., and Dargush, G. F. (1998). *Passive energy dissipation systems for structural design and retrofit, Monograph 1*, Multidisciplinary Center for Earthquake Engineering Research, University of Buffalo, State University of New York, Buffalo.
- Constantinou, M. C., Whittaker, A. S., Kalpakidis, Y., Fenz, D. M., and Warn, G. P. (2007). "Performance of seismic isolation hardware under service and seismic loading." *Report No. MCEER-07-0012*, Multidisciplinary Center for Earthquake Engineering Research, Buffalo, NY.
- European Committee for Standardization (Eurocode 8). (2005). "Design of structures for earthquake resistance. Part 2: Bridges." *Eurocode 8*, European Committee for Standardization.
- Federal Emergency Management Agency (FEMA). (2005). "Improvement of nonlinear static seismic analysis procedures." *FEMA 440*, FEMA, Washington, DC.
- Hanson, R. D., and Soong, T. T. (2001). "Seismic design with supplemental energy dissipation devices." *MNO-8*, Earthquake Engineering Research Institute, Oakland, CA.

- Makris, N., Roussos, Y., Whittaker, A. S., and Kelly, J. M. (1998). *Viscous heating of fluid dampers. I: Large-amplitude motions*. J. Eng. Mech., Pavlou, E., and Constantinou, M. C. (2004). “Response of elastic and inelastic structures with damping systems to near-field and soft-soil ground motions.” *Engrg. Struct.* 26, 1217–1230.
- Pavlou, E., and Constantinou, M. C. (2006). “Response of nonstructural components in structures with damping systems.” *J. Struct. Engrg.*, 132(7), 1108–1117.
- Rabinowicz, E. (1995). *Friction and wear of materials*, John Wiley & Sons, New York.
- Ramirez, O. M., Constantinou, M. C., Kircher, C. A., Whittaker, A., Johnson, M., Gomez, J. D., et al. (2001). “Development and evaluation of simplified procedures of analysis and design for structures with passive energy dissipation systems.” *Technical Report MCEER-00-0010*, Revision 1, Multidisciplinary Center for Earthquake Engineering Research, University of Buffalo, State University of New York, Buffalo.
- Skinner, R. I., Robinson, W. H., and McVerry, G. H. (1993). *An introduction to seismic isolation*, John Wiley & Sons, Chichester, UK.
- Soong, T. T., and Dargush, G. F. (1997). *Passive energy dissipation systems in structural engineering*, John Wiley & Sons, London.

OTHER REFERENCES (NOT CITED)

- Miyamoto, H. K., Gilani, A. S. J., Wada, A., and Ariyaratana, C. (2011). “Identifying the collapse hazard of steel special moment-frame buildings with viscous dampers using the FEMA P-695 methodology.” *Earthq. Spectra*, 27(4), 1147–1168.
- Newmark, N. M., and Hall, W. J. (1969). *Seismic design criteria for nuclear reactor facilities*. Proc., 4th World Conference in Earthquake Engineering, Santiago, Chile.
- Ramirez, O. M., Constantinou, M. C., Gomez, J., Whittaker, A. S., and Chrysostomou, C. Z. (2002a). “Evaluation of simplified methods of analysis of yielding structures with damping systems.” *Earthq. Spectra*, 18(3), 501–530.
- Ramirez, O. M., Constantinou, M. C., Whittaker, A. S., Kircher, C. A., and Chrysostomou, C. Z. (2002b). “Elastic and inelastic seismic response of buildings with damping systems.” *Earthq. Spectra*, 18(3), 531–547.
- Ramirez, O. M., Constantinou, M. C., Whittaker, A. S., Kircher, C. A., Johnson, M. W., and Chrysostomou, C. Z. (2003). “Validation of 2000 NEHRP provisions equivalent lateral force and modal analysis procedures for buildings with damping systems.” *Earthq. Spectra*, 19(4), 981–999.
- Structural Engineers Association of California (SEAOC). (2013). 2012 *IBC SEAOC structural/seismic design manual Volume 5: Examples for seismically isolated buildings and buildings with supplemental damping*, Sacramento, CA.
- Whittaker, A. S., Constantinou, M. C., Ramirez, O. M., Johnson, M. W., and Chrysostomou, C. Z. (2003). “Equivalent lateral force and modal analysis procedures of the 2000 NEHRP provisions for buildings with damping systems.” *Earthq. Spectra*, 19(4), 959–980.

Page intentionally left blank.

COMMENTARY TO CHAPTER 19, SOIL-STRUCTURE INTERACTION FOR SEISMIC DESIGN

C19.1 GENERAL

In an earthquake, the shaking is transmitted up through the structure from the geologic media underlying and surrounding the foundation. The response of a structure to earthquake shaking is affected by interactions among three linked systems: the structure, the foundation, and the geologic media underlying and surrounding the foundation. The analysis procedures in Chapters 12 and 15 idealize the response of the structure by applying forces to the structure, which is typically assumed to have a fixed base at the foundation–soil interface. In some cases, the flexibility of the foundation elements and underlying soils is included in the analysis model. The forces that are applied to the structure are devised based on parameters representing free-field ground motions. The term “free-field” refers to motions not affected by structural vibrations or the foundation characteristics of the specific structure and represents the condition for which the design spectrum is derived using the procedures given in Chapter 11 and Chapter 21. In most cases, however, the motions at the foundation that are imparted to the structure are different from the free-field motions. This difference is caused by the effects of the interaction of the structure and the geologic media. A seismic soil–structure interaction (SSI) analysis evaluates the collective response of these systems to a specified free-field ground motion.

SSI effects are absent for the theoretical condition of rigid geologic media, which is typical of analytical models of structures. Accordingly, SSI effects reflect the differences between the actual response of the structure and the response for the theoretical, rigid base condition. Visualized within this context, two following SSI effects can significantly affect the response of structures:

1. **Foundation Deformations.** Flexural, axial, and shear deformations of foundation elements occur as a result of loads applied by the superstructure and the supporting geologic media. Additionally, the underlying geologic media deforms because of loads from the foundations. Such deformations represent the seismic demand for which foundation components should be designed. These deformations can also significantly affect the overall system behavior, especially with respect to damping.
2. **Inertial SSI Effects.** Inertia developed in a vibrating structure gives rise to base shear, moment, and torsional excitation, and these loads in turn cause displacements and rotations of the foundation relative to the free-field displacement. These relative displacements and rotations are only possible because of flexibility in the soil–foundation system, which can significantly contribute to the overall structural flexibility in some cases. Moreover, the relative foundation free-field motions give rise to energy dissipation via radiation damping (i.e., damping associated with wave propagation into the ground away from the foundation, which acts as the wave source) and hysteretic soil damping, and this energy dissipation can significantly affect the overall damping of the soil–foundation–structure system. Because these effects are rooted in the structural inertia, they are referred to as inertial interaction effects.
3. **Kinematic SSI Effects.** Kinematic SSI results from the presence of foundation elements on or in soil that are much stiffer than the surrounding soil. This difference in stiffness causes foundation motions to deviate from free-field motion as a result of base slab averaging and embedment effects.

Chapter 19 addresses both types of SSI effects. Procedures for calculating kinematic and inertial SSI effects were taken from recommendations in NIST GCR 12-917-21 (NIST 2012). Further discussion of SSI effects can be found in this NIST document and some of the references cited therein.

Substantial revisions have been made to Chapter 19 in this edition of ASCE 7. They include (1) the introduction of formulas for the stiffness and damping of rectangular foundations, (2) revisions to the formulas for the reduction of base shear caused by SSI, (3) reformulation of the effective damping ratio of

the SSI system, (4) introduction of an effective period lengthening ratio, which appears in the formula for the effective damping ratio of the SSI system, and which depends on the expected structural ductility demand, and (5) the introduction of kinematic SSI provisions. Most of these revisions come from the NIST GCR 12-917-21 (NIST 2012) report on SSI. However, the basic model of the inertial SSI system has remained the same since SSI provisions were first introduced in the ATC 3-06 report (ATC 1978).

The first effect, foundation deformation, is addressed by explicitly requiring the design professional to incorporate the deformation characteristics of the foundation into their analysis model. Including foundation deformations is essential for understanding soil–structure interaction (SSI). Therefore, the flexibility of the foundation must be modeled to capture translational and rotational movement of the structure at the soil–foundation interface.

For the linear procedures, this requirement to model the flexibility of the foundation and soil means that springs should be placed in the model to approximate the effective linear stiffness of the deformations of the underlying geologic media and the foundation elements. This could be done by placing isolated spring elements under the columns and walls, by explicitly modeling the foundation elements and geologic media in the mathematical model, or some combination of the two. For the response history procedure, this would mean that in addition to the stiffness of the subsurface media and foundation elements, the nonlinear parameters of those materials would be incorporated into the analytical model. Because of the uncertainty in estimating the stiffness and deformation capacity of geologic media, upper and lower bound estimates of the properties should be used and the condition that produces the more conservative change in response parameters from a fixed-base structure must be used.

Inertial interaction effects are addressed through the consideration of foundation damping. Inertial interaction in structures tends to be important for stiff structural systems such as shear walls and braced frames, particularly where the foundation soil is relatively soft. The provisions provide a method for estimating radiation damping and soil hysteretic damping.

The two main kinematic interaction effects are included in these provisions: base slab averaging and embedment effects. The kinematic interaction effects cause the motion input into the structure to be different from the free-field motions. The provisions provide a means by which a free-field, site-specific response spectrum can be modified to account for these kinematic interaction effects to produce a foundation-input spectrum.

Site classes A and B are excluded from Chapter 19 because the dynamic interaction between structures and rock is minimal based on theory. Furthermore, there are no empirical data to indicate otherwise.

Section 19.1.1 prohibits using the cap of S_s included in Section 12.8.1.3 because of the belief that structures meeting the requirements of that section have performed satisfactorily in past earthquakes, partially because of SSI effects. Taking advantage of that predetermined cap on S_s and then subsequently reducing the base shear caused by SSI effects may therefore amount to double-counting the SSI effects.

C19.2 SSI ADJUSTED STRUCTURAL DEMANDS

When the equivalent lateral force procedure is used, the equivalent lateral force is computed using the period of the flexible base structure and is modified for the SSI system damping. For the modal analysis procedure, a response spectrum, which has been modified for the SSI system damping and then divided by (R/I_e) , is input into the mathematical model. The lower bound limit on the design base shear based on the equivalent lateral force procedures per Section 12.9.1.4 still applies, but the equivalent lateral force base shear modified to account for SSI effects replaces the base shear for the fixed-base case.

For both the equivalent lateral force and response spectrum procedures, the total reduction caused by SSI effects is limited to a percentage of the base shear determined in accordance with Section 12.8.1, which

varies based on the R factor. This limitation on potential reductions caused by SSI reflects the limited understanding of how the effects of SSI interact with the R factor. All of the SSI effects presented herein are based on theoretical linear elastic models of the structure and geologic media. That is why reductions of 30% are permitted for $R = 3$ or less. It is felt that those systems exhibit limited inelastic response and therefore, a larger reduction in the design force caused by SSI should be permitted. For higher R factor systems, where significant damping caused by structural yielding is expected, the contribution of foundation damping is assumed to have little effect on the reduction of the response. Some reduction is permitted because of (1) an assumed period lengthening resulting from the incorporation of base flexibility, (2) potential reduction in mass participation in the fundamental mode because two additional degrees of freedom are present caused by translation and rotation of the base, and (3) limited foundation damping interacting with the structural damping.

Reductions to the response spectrum caused by the SSI system damping and kinematic SSI effects are for the elastic 5% damped response spectrum typically provided to characterize free-field motion. In addition, studies have indicated that there is a fair amount of uncertainty in the amount of kinematic SSI when measured reductions between the free-field motion and the foundation input motion are compared with the theoretical models (Stewart 2000).

Reductions for kinematic SSI effects are not permitted for the equivalent lateral force and modal response spectrum procedures. The equations for predicting the kinematic SSI effects are based on modifications to the linear elastic response spectrum. Studies have not been performed to verify if they are similarly valid for inelastic response spectra, on which the R factor procedures are based. Additionally, the amount of the reduction for kinematic SSI effects is dependent on the period of the structure, with the greatest modifications occurring in the short period range. Because the fundamental periods of most structures lengthen as they yield, what would potentially be a significant reduction at the initial elastic period may become a smaller reduction as the structure yields. Without an understanding of how the period may lengthen in the equivalent lateral force or modal response spectrum procedures, there is a potential for a user to overestimate the reduction in the response parameters caused by kinematic SSI effects. Thus, their use is not permitted.

All types of SSI effects are permitted to be considered in a response history analysis per Chapter 16. If SSI effects are considered, the site-specific response spectrum should be used as the target to which the acceleration histories are scaled. The requirement to use a site-specific response spectrum was placed in the provisions because of the belief that it provided a more realistic definition of the earthquake shaking than is provided by the design response spectrum and MCE_R response spectrum in accordance with Sections 11.4.6 and 11.4.7. A more realistic spectrum was required for proper consideration of SSI effects, particularly kinematic SSI effects. The design response spectrum and MCE_R response spectrum, in accordance with Sections 11.4.6 and 11.4.7, use predetermined factors to modify the probabilistic or deterministic response spectrum for the soil conditions. These factors are sufficient for most design situations. However, if SSI effects are to be considered and the response spectrum modified accordingly, then more accurate representations of how the underlying geologic media alter the spectral ordinates should be included before the spectrum is modified because of the SSI effects.

A site-specific response spectrum that includes the effects of SSI can be developed with explicit consideration of SSI effects by modifying the spectrum developed for free-field motions through the use of the provisions in Sections 19.3 and 19.4. If the foundation damping is not specifically modeled in the analytical model of the structure, the input response spectrum can include the effects of foundation damping. Typically, the base slab averaging effect is not explicitly modeled in the development of a site-specific response spectrum and the provisions in Section 19.4.1 are used to modify the free-field, site-specific response spectrum to obtain the foundation input spectrum. Embedment effects can be modeled directly by developing the site-specific spectrum at the foundation base level, as opposed to the ground

surface. Alternatively, the site-specific spectrum for the free field can be developed at the ground level and the provisions of Section 19.4.2 can be used to adjust it to the depth corresponding to the base of foundation.

The limitations on the reductions from the site-specific, free-field spectrum to the foundation input spectrum are based on several factors. The first is the scatter between measured ratios of foundation input motion to free-field motion versus the ratios from theoretical models (Stewart 2000). The second is the inherent variability of the properties of the underlying geologic media over the footprint of the structure. Whereas there is a requirement to bound the flexibility of the soil and foundation springs, there are no corresponding bounding requirements applied to the geologic media parameters used to compute the foundation damping and kinematic SSI. The last factor is the aforementioned lack of research into the interaction between SSI effects and yielding structures. Some studies have shown that there are reductions for most cases of SSI when coupled with an R factor based approach (Jarernprasert et al. 2013).

A limitation was placed on the maximum reduction for an SSI modified site-specific response spectrum with respect to the response spectrum developed based on the USGS ground-motion parameters and the site coefficients. This limitation is caused by similar concerns expressed in Section C21.3 regarding the site-specific hazard studies generating unreasonably low response spectra. There is a similar concern that combining SSI effects with site-specific ground motions could significantly reduce the seismic demand from that based on the USGS ground-motion parameters and the site coefficients. However, it was recognized that these modifications are real and the limit could be relaxed, but not eliminated, if there were (1) adequate peer review of the site-specific seismic hazard analysis and the methods used to determine the reductions attributable to SSI effects and (2) approval of the jurisdictional authority.

Peer review would include, but not be limited, to the following:

1. Development of the site-specific response spectrum used to scale the ground motions;
2. Determination of foundation stiffness and damping, including the properties of the underlying subsurface media used in the determination;
3. Confirmation that the base slab and first slab above the base are sufficiently rigid to allow base slab averaging to occur, including verification that the base slab is detailed to act as a diaphragm; and
4. Assumptions used in the development of the soil and radiation damping ratios.

The SSI effects can be used in a response history analysis per Chapter 16. Two options for the modeling of the SSI are as follows:

1. Create a nonlinear finite element (FE) model of the structure, foundation, and geologic media. The mesh for the geologic media should extend to an appropriate depth and horizontal distance away from the foundation with transmitting boundaries along the sides to absorb outgoing seismic waves generated by the foundation. The motion should be input at the base of the FE model and should propagate upward as shear waves. The free-field response spectrum can be reduced for kinematic SSI only per the provisions in Section 19.4, but embedment effects would not be allowed in the reduction because the waves propagating up from the depth of the foundation to the surface would automatically include kinematic effects of embedment.
2. Create a nonlinear finite element model of the structure and foundation, with springs and dashpots attached to the perimeter walls and base of the foundation to account for the soil–foundation interaction. Guidance on the development of dashpots can be found in NIST GCR 12-917-21 (NIST 2012). The free-field response spectrum can be reduced for kinematic SSI per Section 19.4, but embedment effects may or may not be allowed in the reduction depending on whether or not (i) the motion is allowed to vary with depth along the embedded portion of the foundation, and (ii) the free-field motion used as input motion is defined at the ground surface or at the bottom of the basement. The dashpots would account for the radiation and hysteretic damping of the geologic media, either per Section 19.3 or more detailed formulations.

C19.3 FOUNDATION DAMPING EFFECTS

The procedures in Section 19.3 are used to estimate an SSI system damping ratio, β_0 , based on the underlying geologic media and interaction of the structure and its foundation with this geologic media.

Section 19.3 includes Tables 19.3-1, Table 19.3-2 and Tables 19.3-3, which provide values for three parameters that are used in the evaluation of damping in an SSI system: (1) effective shear wave velocity ratios (Table 19.3-1), (2) effective shear modulus ratios (Table 19.3-2), and (3) soil hysteretic damping ratios (Table 19.3-3). These parameters represent different effects of soil nonlinearity, which has a fundamental dependence on shear strain. Strain levels are indirectly represented in the tables by different site classes and different ranges of effective peak acceleration. All other factors being equal, strains (and nonlinear effects on the respective parameters) increase as site conditions soften and effective peak accelerations increase. For each of the three identified tables, new values of the associated ratios were added in 2019 to account for the new site classes added in Chapter 20. The new values are derived by log-linear interpolation.

There are two main components that contribute to foundation damping: soil hysteretic damping and radiation damping. The provisions in this section provide simplified ways to approximate these effects. However, they are complex phenomena and there are considerably more detailed methods to predict their effects on structures. The majority of the provisions in this section are based on material in NIST GCR 12-917-21 (NIST 2012). Detailed explanations of the background of these provisions, supplemental references, and more sophisticated methods for predicting radiation damping can be found in that report. However, those references do not provide the derivation of the effective period lengthening ratio, $(\tilde{T}/T)_{\text{eff}}$ given by Eq. (19.3-2). This ratio appears in the equation for β_0 (Eq. (19.3-1)), and it is derived from the total displacement of the mass of the SSI oscillator model resulting from a horizontal force applied to the mass. A component of this displacement is the displacement of the mass relative to its base, and it is equal to the ductility demand, μ , times the elastic displacement of the mass relative to the base. The other components of the total displacement arise from displacement of the translational foundation spring (K_y or K_r) and the translation resulting from the rotational foundation spring (K_{xx} or K_{rr}). The period lengthening ratio, (\tilde{T}/T) appearing in Eq. (19.3-2) is derived in the same manner assuming that $\mu = 1$.

Radiation damping refers to energy dissipation from wave propagation away from the vibrating foundation. As the ground shaking is transmitted into the structure's foundation, the structure itself begins to translate and rock. The motion of the foundation relative to the free-field motion creates waves in the geologic media, which can act to counter the waves being transmitted through the geologic media caused by the earthquake shaking. The interference is dependent on the stiffness of the geologic media and the structure, the size of the foundation, type of underlying geologic media, and period of the structure. The equations for radiation damping in Section 19.3.3 were taken from NIST GCR 12-917-21 (NIST 2012); details of the derivation are found in Givens (2013).

In Section 19.3.3, the equations for K_y and K_{xx} , for rectangular foundations, and the associated damping ratios, β_y and β_{xx} , come from Pais and Kausel (1988) and are listed in Table 2-2a and Table 2-3a in the NIST report. The corresponding static stiffness equations for circular foundations in Section 19.3.4 were taken from Veletsos and Verbic (1973); the other equations appearing in Section 19.3.4 were adapted from equations in the NIST report. The foundation stiffness and damping equations in these two sections apply to surface foundations. The reasons for excluding embedment effects are explained in the third paragraph from the end of this subsection.

Soil hysteretic damping occurs because of shearing within the soil and at the soil–foundation interface. Values of the equivalent viscous damping ratio, β_s , to model the hysteretic damping can be obtained from site response analysis or Table 19.3-3.

Foundation damping effects, modeled by β_f , tend to be important for stiff structural systems such as shear walls and braced frames, particularly where they are supported on relatively soft soil sites, such as Site Classes D and E. This effect is determined by taking the ratio of the fundamental period of the structure, including the flexibility of the foundation and underlying subsurface media (flexible-base model) and the fundamental period of the structure assuming infinite rigidity of the foundation and underlying subsurface media (fixed-base model). Analytically, this ratio can be determined by computing the period of the structure with the foundation/soil springs in the model and then replacing those springs with rigid support.

Figure C19.3-1 illustrates the effect of the period ratio, \tilde{T}/T , on the radiation damping, β_r , which typically accounts for most of the foundation damping. \tilde{T}/T is the ratio of the fundamental period of the SSI system to the period of the fixed-base structure. The Figure shows that for structures with larger height, h , to foundation half-width, B , aspect ratios, the effects of foundation damping become less. In this Figure, the aspect ratio of the foundation is assumed to be square.

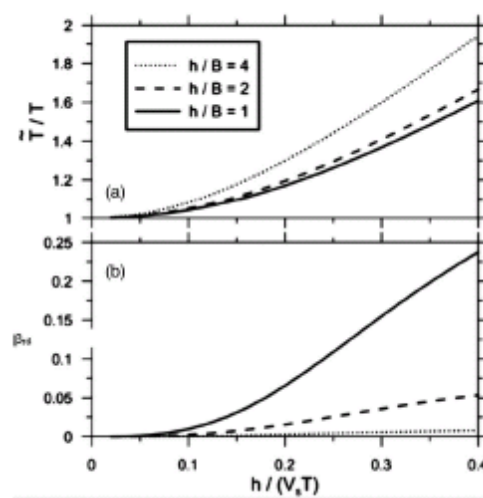

FIGURE C19.3-1 Example of Radiation Damping

Source: NIST 2012.

These inertial interaction effects are influenced considerably by the shear modulus of the underlying subgrade, specifically the modulus that coincides with the seismic shaking being considered. As noted in the standard, shear modulus G can be evaluated from small-strain shear wave velocity as $G = (G/G_o)G_o = (G/G_o)\gamma v_{so}^2/g$ (all terms defined in the standard). Shear wave velocity, v_{so} , should be evaluated as the average small-strain shear wave velocity within the effective depth of influence below the foundation. The effective depth should be taken as half the lesser dimension of the foundation, which in the provisions is defined as B . Methods for measuring v_{so} (preferred) or estimating it from other soil properties are summarized elsewhere (e.g., Kramer 1996).

The radiation damping procedure is conservative and underestimates the foundation damping for shaking in the long direction where the foundation aspect ratios exceed 2:1 but could be potentially unconservative where wall and frame elements are close enough so that waves emanating from distinct foundation

components destructively interfere with each other across the period range of interest. That is why the limit of spacing of the vertical lateral force-resisting elements is imposed on the use of these provisions.

For structures supported on footings, the formulas for radiation damping can generally be used with B and L calculated using the footprint dimensions of the entire structure, provided that the footings are interconnected with grade beams and/or a sufficiently rigid slab on grade. An exception can occur for structures with both shear walls and frames, for which the rotation of the foundation beneath the wall may be independent of that for the foundation beneath the column (this type is referred to as weak rotational coupling). In such cases, B and L are often best calculated using the dimensions of the wall footing. Very stiff foundations like structural mats, which provide strong rotational coupling, are best described using B and L values that reflect the full foundation dimension. Regardless of the degree of rotational coupling, B and L should be calculated using the full foundation dimension if foundation elements are interconnected or continuous. Further discussion can be found in FEMA 440 (FEMA 2005) and NIST GCR 12-917-21 (NIST 2012).

The radiation damping provisions conservatively exclude the effects of embedment. Embedment typically increases the amount of radiation damping if the basement or below-grade foundation stays in contact with the soil on all sides. Because there is typically some gapping between the soil and the sides of the basement or foundation, these embedment effects may be less than the models predict. There are some additional issues with the procedures for embedded foundations. For the case where the embedment is significant but the soils along the sides are much more flexible than the bearing soils, a high impedance contrast between the first two layers is recognized as a potential problem regardless of the embedment. The NIST GCR 12-917-21 (NIST 2012) report therefore recommends ignoring the additional contributions caused by embedment but still using the soil properties derived below the embedded base.

The equations in Sections 19.3.3 and 19.3.4 are for shallow foundations. This is not to say that radiation damping does not occur with deep (pile or caisson) foundation systems, but the phenomenon is more complex. Soil layering and group effects are important, and there are the issues of the possible contributions of the bottom structural slab and pile caps. Because the provisions are based on the impedance produced by a rigid plate in soil, these items cannot be easily taken into account. Therefore, more detailed modeling of the soil and the embedded foundations is required to determine the foundation impedances. The provisions permit such modeling but do not provide specific guidance for it. Guidance can be found for example in NIST GCR 12-917-21 (NIST 2012) and its references.

Soil hysteretic damping occurs as seismic waves propagate through the subsurface media and reach the base of the structure, and it can have an effect on the overall system damping when the soil strains are high. Table 19.3-3 in the provisions was derived based on relationships found in EPRI (1993) and Vucetic and Dobry (1991) that relate the ratio between G/G_0 to cyclic shear strain in the soil, and then to soil damping.

The values in the table are based on conservative assumptions about overburden pressures on granular soils and plasticity index of clayey soils. This simplified approach does not preclude the geotechnical engineer from providing more detailed estimates of soil damping. However, the cap on reductions in the seismic demand are typically reached at around an additional 5% hysteretic damping ratio (10% total damping ratio), and further reductions would require peer review.

C19.4 KINEMATIC SSI EFFECTS

Kinematic SSI effects are broadly defined as the difference between the ground motion measured in a free-field condition and the motion which would be measured at the structure's foundation, assuming that it and the structure were massless (i.e., inertial SSI was absent). The differences between free-field and foundation input motions are caused by the characteristics of the structure foundation, exclusive of the soil and radiation damping effects in the preceding section. There are two main types of kinematic interaction effects: base slab averaging and embedment. The provisions provide simplified methods for capturing these

effects. The basis for the provisions and additional background material can be found in FEMA 440 (FEMA 2005) and NIST GCR 12-917-21 (NIST 2012).

FEMA 440 (FEMA 2005) specifically recommends against applying these provisions to very soft soil sites such as E and F. These provisions allow kinematic SSI for Site Class E but retain the prohibition for Site Class F. That is not to say that kinematic interaction effects are not present at Site Class F sites, but that these specific provisions should not be used; rather, more detailed site-specific assessments are permitted to be used to determine the possible modifications at those sites.

In addition to the prescriptive methods contained in the standard, there are also provisions that allow for direct computation of the transfer function of the free-field motion to a foundation input motion caused by base slab averaging or embedment. Guidance on how to develop these transfer functions can be found in NIST GCR 12-917-21 (NIST 2012) and the references contained therein.

C19.4.1 Base Slab Averaging.

Base slab averaging refers to the filtering of high-frequency portions of the ground shaking caused by the incongruence of motion over the base. For this filtering to occur, the base of the structure must be rigid or semirigid with respect to the vertical lateral force-resisting elements and the underlying soil. If the motions are out of phase from one end of the foundation to the other and the foundation is sufficiently rigid, then the motion on the foundation would be different from the ground motion at either end. The ground motions at any point under the structure are not in phase with ground motions at other points along the base of the structure. That incongruence leads to interference over the base of the structure, which translates into the motions imparted to the foundation, which are different from the ground motions. Typically, this phenomenon results in a filtering out of short-period motions, which is why the reduction effect is much more pronounced in structures with short fundamental periods, as illustrated in Figure C19.4-1.

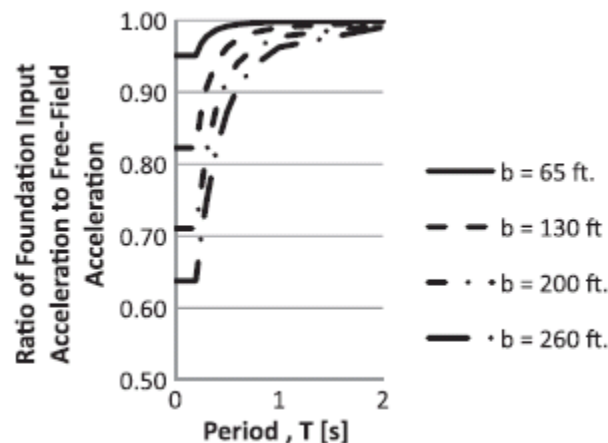

FIGURE C19.4-1 Example of Base Slab Averaging Response Spectra Ratios

Figure C19.4-1 illustrates the increase in reduction as the base area parameter, b_c , increases. This parameter is computed as the square root of the foundation area. Therefore, for larger foundations, base slab averaging effects are more significant.

For base slab averaging effects to occur, foundation components must be interconnected with grade beams or a concrete slab that is sufficiently stiff to permit the base to move as a unit and allow this filtering effect to occur. That is why requirements are placed on the rigidity of the foundation diaphragm relative to the vertical lateral force-resisting elements at the first story. Additionally, requirements are placed on the floor diaphragm or roof diaphragm, in the case of a one-story structure needing to be stiff in order for this filtering of ground motion to occur. FEMA 440 (FEMA 2005) indicates that there is a lack of data regarding this

effect when either the base slab is not interconnected or the floor diaphragms are flexible. It is postulated that reductions between the ground motion and the foundation input motion may still occur. Because cases like this have not been studied in FEMA 440 (FEMA 2005) and NIST GCR 12-917-21 (NIST 2012) explicitly, the requirements for foundation connectivity and stiff or rigid diaphragms above the foundation have been incorporated into the provisions.

The underlying models have only been studied up to an effective base size of 260 ft (79.2 m), which is why that limitation has been placed on Eq. (19.4-4). FEMA 440 (FEMA 2005) postulates that this effect is likely to still occur for larger base areas, but there has not been sufficient study to compare the underlying equations to data at larger effective base sizes.

Also, because the reduction can become quite significant and because studies of these phenomena have indicated variability between the theoretically predicted modifications and actual measured modifications (Stewart et al. 1999, Stewart 2000), a 0.75 factor is applied to the equations that are found in NIST GCR 12-917-21 (NIST 2012) to provide an upper bound estimate of the reduction factors with respect to the theoretical models. This is why the equations differ from those found in FEMA 440 (FEMA 2005).

Lastly, the method has not been rigorously studied for structures on piles (NIST 2012); however, it is considered reasonable to extend the application to pile-supported structures in which the pile caps are in contact with the soil and are laterally connected to one another. Another justification is that some of the empirical data for kinematic SSI come from pile-supported structures.

C19.4.2 Embedment.

The kinematic interaction effects caused by embedment occur because the seismic motions vary with depth below the ground surface. It is common for these effects to be directly considered in a site-specific response spectrum by generating response spectra and acceleration histories at the embedded base of the structure instead of the ground surface. If that is not done, then these effects can be accounted for using the provisions in this section. However, these provisions should not be used if the response spectrum has already been developed at the embedded base of the structure. The embedment effect model was largely based on studies of structures with basements. The provisions can also be applied to structures with embedded foundations without basements where the foundation is laterally connected at the plane taken as the embedment depth. However, the provisions are not applicable to embedded individual spread footings.

As with base slab averaging, the reduction can become quite significant, and studies of these phenomena have indicated variability between the theoretically predicted modifications and actual measured modifications (Stewart et al. 1999). Again, a 0.75 factor is applied to the equations found in NIST GCR 12-917-21 (NIST 2012) to provide a slightly conservative estimate of the reductions with respect to the theoretical models. This is why the equations differ from those found in FEMA 440 (FEMA 2005) and NIST GCR 12-917-21 (NIST 2012). Additionally, the underlying models upon which the provisions are based have only been validated in NIST GCR 12-917-21 (NIST 2012) up to an effective embedment depth of approximately 20 ft (6.096 m), which is why a depth limitation has been placed on Eq. (19.2-4).

REFERENCES

- Applied Technology Council (ATC). (1978). "Tentative provisions for the development of seismic regulations for buildings," *ATC-3-06*, Redwood City, CA.
- Electrical Power Research Institute (EPRI). (1993). "Guidelines for determining design basis ground motions," *EPRI TR-102293*, EPRI, Palo Alto, CA.
- Federal Emergency Management Agency (FEMA). (2005). "Improvement of nonlinear static seismic analysis procedures," *FEMA 440*. FEMA, Washington, DC.
- Givens, M. J. (2013). *Dynamic soil-structure interaction of instrumented buildings and test structures*, Ph.D. Thesis, University of California, Los Angeles, CA.

- Jarernprasert, S., Bazan-Zurita, E., and Bielak, J. (2013). "Seismic soilstructure interaction response of inelastic structures." *Soil Dyn. Earthq. Eng.*, 47, 132–143.
- Kramer, S. L. (1996). *Geotechnical earthquake engineering*, Prentice Hall, Upper Saddle River, NJ.
- National Institute of Standards and Technology (NIST). (2012). *Soil-structure interaction for building structures, NIST GCR 12-917-21*. NIST, Gaithersburg, MD.
- Pais, A., and Kausel, E. (1988). "Approximate formulas for the dynamic stiffness of rigid foundations." *Soil Dyn. Earthq. Eng.*, 7(4), 213–227.
- Stewart, J. P. (2000). "Variations between foundation-level and free-field earthquake ground motions," *Earthq. Spectra*, 16(2), 511–532.
- Stewart, J. P., Seed, R. B., and Fenves, G. L. (1999). "Seismic soil-structure interaction in buildings. II: Empirical findings." *J. Geotech. Geoenviron. Engrg.*, 125(1), 38–48.
- Veletsos, A. S., and Verbic, B. (1973). "Vibration of viscoelastic foundations." *Earthq. Engrg. Struct. Dyn.* 2(1), 87–105.
- Vucetic, M., and R., Dobry (1991). "Effect of soil plasticity on cyclic response." *J. Geotech. Eng.*, 117, 89–107.

Page intentionally left blank.

COMMENTARY TO CHAPTER 20, SITE CLASSIFICATION PROCEDURE FOR SEISMIC DESIGN

C20.1 SITE CLASSIFICATION

Site classification procedures are given in Chapter 20 for the purpose of classifying the site, which is required for the development of site-compatible risk-targeted maximum considered earthquake ground motions, in accordance with Section 11.4.2. Site classification procedures are also used to define the site conditions for which site-specific site response analyses are required to obtain site ground motions in accordance with Section 11.4.7 and Chapter 21.

Site class is defined fundamentally in terms of ranges of site shear wave velocity (\bar{v}_s). Table 20.2-1 includes the six site classes of ASCE 7-16 (A, B, C, D, E and F) plus three new site classes (BC, CD and DE) that provide better resolution of site shear wave velocity and associated site amplification for common site conditions. The site-specific data required to classify a site can be developed from a geotechnical investigation, which may include seismic velocity testing and/or the development of other data on the site profile that can be used to estimate shear wave velocity as a function of depth. In cases where there is inadequate information upon which to base a site classification, a ‘default’ condition is defined. Section 11.4.2.1 defines the “default” site class as the most critical spectral response acceleration response for site conditions of Site Classes C, CD and D and the MCE_R response spectrum for default site conditions would be determined as the envelope of Site Class C, CD and D MCE_R response spectra.

C20.2 SITE CLASS DEFINITIONS

C20.2.1 Site Class F.

The ground motion models used to develop MCE_R spectral ordinates in Section 11.4.3 are derived in part from ground motion recordings, which span a range of conditions of \bar{v}_s between about 150 and 1500 m/s. Site Class F conditions are largely not represented in the databases upon which these ground motions are based; hence, the models are generally thought to be ineffective for such conditions. For this reason, site-specific site response analyses are required for Site Class F soils.

This section defines the types of site conditions for which Site Class F is assigned. For three of the categories of Site Class F soils—Category 1 liquefiable soils, Category 3 very high plasticity clays, and Category 4 very thick soft/medium stiff clays—exceptions to the requirement to conduct site response analyses are given, provided that certain conditions and requirements are satisfied. These exceptions are discussed below.

Category 1. For liquefiable soils in Category 1, an exception is made for short-period structures, defined for purposes of the exception as having fundamental periods of vibration equal to or less than 0.5 seconds. For such structures, it is permissible to develop ground motions under the assumption that liquefaction does not occur. This exception is based on observations that ground motion data obtained in liquefied soil areas during earthquakes indicate that short-period ground motions are generally reduced in amplitude because of liquefaction, whereas long-period ground motions may be amplified by liquefaction (e.g. Youd and Carter, 2005). Other work since 2005 has confirmed the amplification effects at long periods but has not always found reductions of short period ground motion (e.g. Gingery et al., 2015). Note, however, that this exception does not affect the requirement in Section 11.8 to assess liquefaction potential as a geologic hazard and develop hazard mitigation measures, if required.

Categories 3 and 4. For high plasticity clays in Category 3 and thick soft/medium stiff clays in Category 4, site-specific response analyses are required because of the potential for large site-specific amplification effects that are concentrated at one or more site periods. Such effects are not captured well by the site amplification effects incorporated into ground motion models. Procedures for conducting such analyses are described in Chapter 21 and in literature on non-ergodic (i.e., site-specific) site response (e.g., Stewart et

al. 2014, 2017; Rodriguez-Marek et al. 2014; NCHRP 2012). Exceptions for Categories 3 and 4 are limited to sites of expected low amplitude ground motions, i.e., Seismic Design Categories A and B as defined in Tables 11.6-1 and 11.6-2.

Sections C20.2.2 through C20.2.5. These sections and Table 20.2-1 provide definitions for Site Classes A through E. Except for the additional definitions for Site Class E in Section 20.2.2, the site classes are defined fundamentally in terms of the average small-strain shear wave velocity measured from the ground surface to a depth of 100 ft (30 m) of the soil or rock profile.

In general, the soil profile should not be taken from the foundation-level elevation downward when that elevation is below the natural ground surface, which is sometimes done with the intent of accounting for foundation embedment effects on ground motions. Ground motions at the foundation level of embedded structures are lower than those at the ground surface. Such reductions can be especially pronounced for sites with a soft soil layer overlying a much stiffer material, and for which the planned structure is embedded and bearing on the stiffer layer. These effects can be accounted for in an approximate manner using models for kinematic soil-structure interaction in Chapter 19 and NIST (2012) or with site-specific ground response analyses. In the case of site-specific ground response analyses, ground motions should be computed at the foundation level elevations and at the ground surface, and the ratio of the response spectral ordinates computed. This ratio can be applied to the ground surface spectrum to estimate the foundation level spectrum. The use of either approximate or site-specific methods will reduce short period spectral ordinates (i.e., typically periods less than 1.0 sec).

If shear wave velocities are available for the site, they should be used to evaluate \bar{v}_s for site classification per Section 20.4. When measured shear wave velocities in soil materials are not available for the site, shear wave velocity can be estimated based on appropriate correlations (Section 20.3). If these correlation relationships are used, mean shear wave velocity should be estimated as a function of depth, and \bar{v}_s should be computed from the mean profile using procedures in Section 20.4.

When measured shear wave velocities in competent rock with moderate weathering and/or fracturing are not available for the site, site class BC should be assigned. (Section 20.2.4). For softer rock with a higher degree of fracturing and/or weathering, if \bar{v}_s is not based on measurement, site class C should be assigned. Site classes A and B can only be assigned on the basis of seismic velocity measurements (Section 20.2.5).

C20.3 ESTIMATION OF SHEAR WAVE VELOCITY PROFILES

When measured shear wave velocities are not available for a site, shear wave velocity can be estimated from geotechnical data using appropriate correlations. Correlation relationships predict the mean shear wave velocity and variability (typically expressed as a standard deviation or coefficient of variation) given a series of independent variables. Some correlations are based on large data sets encompassing multiple regions ('global' models), while other correlations are derived from local data specific to the geology of a particular region. Where local models are available, and the models are of good quality with appropriate documentation, their use is preferred to global models.

When \bar{v}_s is estimated in this manner, the associated uncertainty has been found to be approximately 0.22 to 0.26 in natural logarithmic units when local shear wave velocity correlation models are used (i.e., for California and Japan; Brandenberg et al. 2010 and Kwak et al. 2015, respectively). This indicates that there is approximately a 68% chance that the actual value of \bar{v}_s is between $\bar{v}_s/1.3$ and $1.3\bar{v}_s$. This will result in two or three site classes being assigned to the site. When a global correlation model is used to estimate shear wave velocity, or a combination of local models is used outside of their calibration region, the associated uncertainty in \bar{v}_s is unknown. However, in order to avoid undue complexity in the implementation of estimated \bar{v}_s values, the same factor of 1.3 was retained for this case.

The independent variables used in correlation models take two major forms: (1) parameters derived from laboratory tests (shear strength, void ratio, water content), and (2) penetration resistance in combination with either depth or effective stress along with information on soil type. Examples of local and geologic unit-specific models of the first type are provided for the Los Angeles area by Fumal and Tinsley (1985) and various clay units in the San Francisco Bay Region by Dickenson (1994), as shown in Figure C20.3-1 to C20.3-3.

Correlation models that use penetration resistance consider three main types of penetration tests: standard penetration testing (SPT), cone penetration testing (CPT), and Becker penetration testing (BPT). SPT is most effective when applied to sandy soils with little or no gravel content. CPT is suitable for fine grained soils (clays, silts) and sands, but not coarser-grained materials like gravels due to difficulties with penetration. The BPT is preferred for gravels.

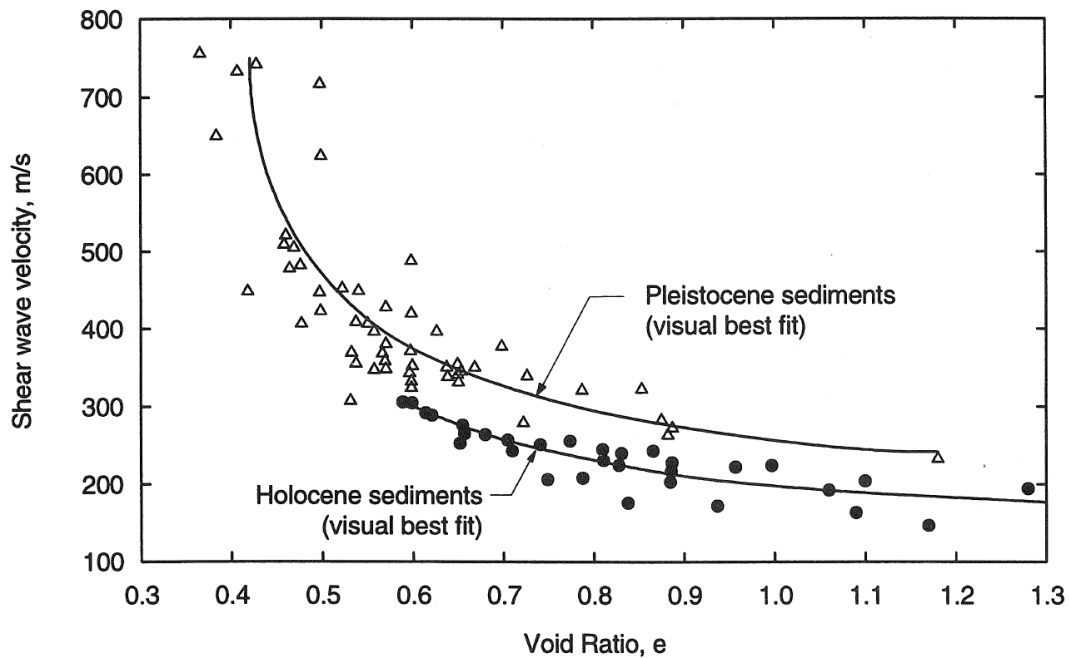

Figure C20.3-1. Variation of shear wave velocity with void ratio for Los Angeles area sediments. Modified from Fumal and Tinsley, 1985

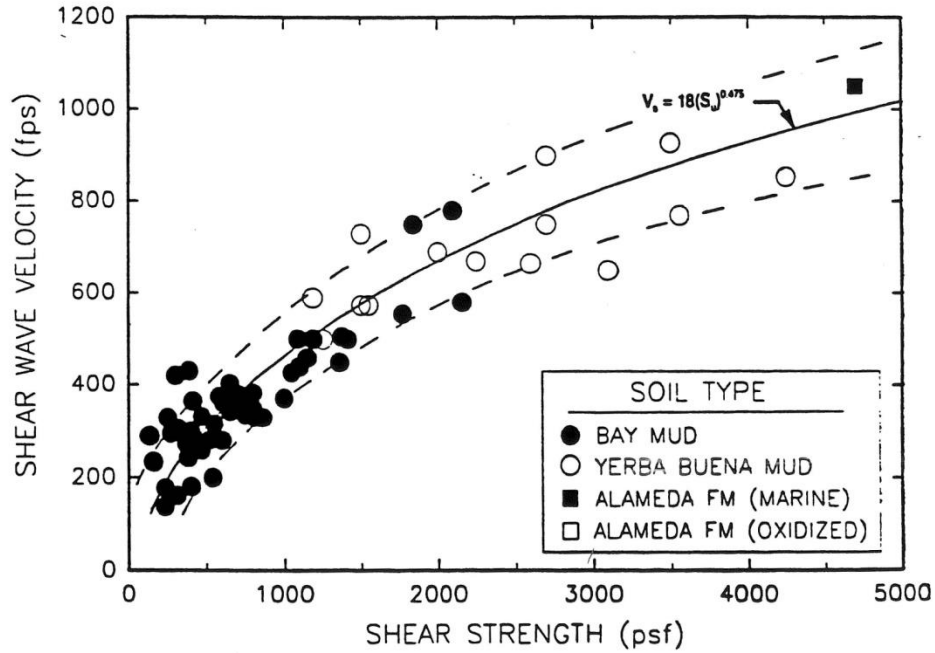

Figure C20.3-2. Variation of shear wave velocity with undrained shear strength (from monotonic triaxial compression testing) for San Francisco Bay Area sediments. Dickenson, 1994

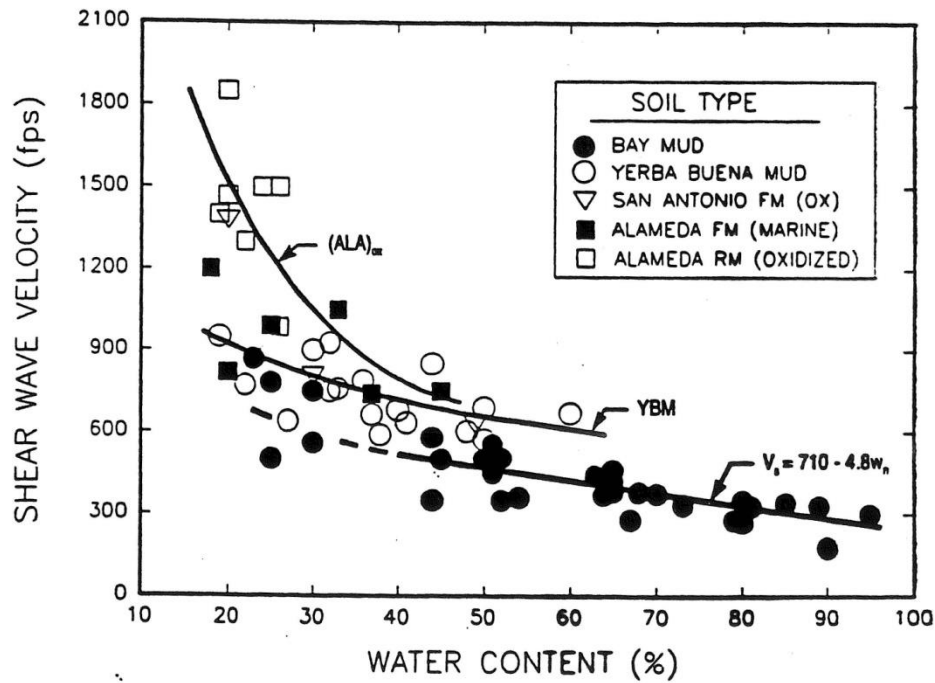

Figure C20.3-3. Variation of shear wave velocity with water content for San Francisco Bay Area sediments. Dickenson, 1994

A general form for V_s prediction models based on penetration resistance is:

$$\ln V_s = c_0 + c_1 \ln(PR) + c_2 \ln f_z + \epsilon \sigma_{\ln V_s} \quad (C20.3-1)$$

where PR is a measure of penetration resistance, f_z is a parameter related to depth, either taken as depth directly or as an effective stress parameter, ε is the standard normal variate (taken as 0 for the mean and +1 for one standard deviation above the mean), and $\sigma_{\ln V_S}$ is the total standard deviation of $\ln V_S$.

One such local model derived using data in California (Brandenberg et al. 2010) takes PR as the SPT blow count at 60% energy efficiency (N_{60}) and f_z as the vertical effective stress, σ'_v , in units of kPa. V_S is provided in units of m/s. The coefficients are soil type-dependent, as given in Table C20.3-1. A variation on this approach for Japanese data has coefficients conditioned on surface geology (Kwak et al. 2015), and future versions of the California model will likely include this feature. The standard deviation term representing data variability relative to the model is $\sigma_{\ln V_S} = \sqrt{\tau^2 + \sigma^2}$, where τ = inter-boring standard deviation and σ = intra-boring standard deviation. Coefficients for both standard deviations are given in Table C20.3-1.

Table C20.3-1 Coefficients for estimation of shear wave velocity in local model applicable to California (after Brandenberg et al., 2010).

Soil type	c_0	c_1	c_2	τ	σ	
					$\sigma'_v \leq 200$ kPa	$\sigma'_v > 200$ kPa
Sand	4.045	0.096	0.236	0.217	$0.57 - 0.07 \ln \sigma'_v$	0.20
Silt	3.783	0.178	0.231	0.227	$0.31 - 0.03 \ln \sigma'_v$	0.15
Clay	3.996	0.230	0.164	0.227	$0.21 - 0.01 \ln \sigma'_v$	0.16

A variation on Eq. (C.20.3-1) is typically applied for CPT data:

$$\ln V_S = c_0 + c_1 \ln(q_t/p_a) + c_2 \ln f_z + c_3 \ln f_m + \varepsilon \sigma_{\ln V_S} \tag{C20.3-2}$$

where q_t is the CPT tip resistance, p_a is atmospheric pressure in the same units as q_t , and f_m is a parameter used to assess material type (typically friction ratio, R_f , or soil behavior type index, I_c ; Robertson, 1990). In CPT models of this type, coefficients c_0 to c_3 are generally fixed (they are not soil type dependent). An exception is Hegazy and Mayne (2006) in which coefficient c_2 depends on I_c . That model, which is based on data from the US, Italy and Japan (and hence can be considered to be global), takes $f_z = p_a/\sigma'_v$, and $f_m = \exp(1.786 I_c)$. Andrus et al. (2007) present a model that is derived primarily using data from South Carolina and California, in which f_z is depth in meters and f_m is taken as I_c . McGann et al. (2015) presents a local model for Christchurch, New Zealand in which f_z is depth in meters and $f_m = f_s/p_a$. Coefficients for these models are given in Table C20.3-2, with the resulting V_S in units of m/s.

Table C20.3-2 Coefficients for estimation of shear wave velocity from CPT data. Hegazy and Mayne (2006) and Andrus et al. (2007) are not region-specific; McGann et al. (2015) is specific to Christchurch, NZ.

Study	c_0	c_1	c_2	c_3	σ_{lnV_s}
Hegazy & Mayne 2006; granular soils ($I_c < 2.6$)	-2.488	1.0	0.25	1.0	Note a
Hegazy & Mayne 2006; cohesive soils ($I_c > 2.6$)			0.5		
Andrus et al. 2007; Holocene Materials	2.699	0.395	0.124	0.912	Note a
Andrus et al. 2007; Pleistocene Materials	2.896				
McGann et al. 2015; Christchurch, NZ	3.959	0.144	0.278	0.0832	Note b

Notes: (a) Standard deviation model not provided; (b) $\sigma_{lnV_s} = 0.162$ (depth $z < 5$ m), $\sigma_{lnV_s} = 0.216 - 0.0108z$ ($z = 5-10$ m), and $\sigma_{lnV_s} = 0.108$ ($z > 10$ m)

Correlations based on BPT are limited in the literature, but one such model is provided by Rollins et al. (1998).

The correlation models described here are not intended to encompass all the models that might be used for V_s prediction. Rather, the intent is to describe the general form of contemporary models to help engineers and regulatory officials judge the efficacy of a candidate model, and to provide a set of models that may be applied in the absence of preferred alternate models for a particular region.

While local models are preferred to global models, there are many regions for which local models either may not exist or may have unknown efficacy. In such cases, global models such as Hegazy and Mayne (2006) could be used, or a series of local models for other regions could be applied. In the latter case, for each depth in the profile, a geometric mean velocity should be taken, and the resulting profile used to compute \bar{v}_s .

Eq. (20.4-1) requires a profile that extends to a depth of 100 ft (30 m) or greater. If the available geophysical or geotechnical information for the site ends at shallower depths (50 ft or greater), it is possible to estimate \bar{v}_s based on the information over the available depth range if the geological conditions at the site are suitable. Such suitability is judged based on the potential for velocity inversions (i.e., a marked decrease in velocity as depth increases); where such inversions could reasonably be anticipated based on the site geology, the use of shallow site characteristics to assess \bar{v}_s is not recommended. Geotechnical characterization should extend to at least 100 ft (30 m) in such cases. For sites where velocity inversions are not expected, a reasonable estimate of \bar{v}_s can generally be obtained by extending the velocity of the last layer in the profile to 100 ft (30 m) for use in Eq. (20.4-1). This approach provides an estimate of \bar{v}_s that is usually slightly lower than alternative methods that implicitly account for the effects of velocity gradient. A summary of such methods, and current best practices, is provided in Kwak et al. (2017).

C20.4 DEFINITIONS OF SITE CLASS PARAMETERS

Section 20.4 provides formulas for computing \bar{v}_s from a shear wave velocity profile, which in turn is used to define site classes in accordance with definitions in Section 20.3 and Table 20.2-1. Eq. (20.4-1) is for determining the time-averaged small-strain shear wave velocity, \bar{v}_s , to a depth of 100 ft (30 m) at a site. This equation defines \bar{v}_s as 100 ft (30 m) divided by the sum of the times for a shear wave to travel through each layer within the upper 100 ft (30 m), where travel time for each layer is calculated as the layer thickness divided by the small-strain shear wave velocity for the layer.

REFERENCES

- Andrus, R.D., Mohanan, N.P., Piratheepan, P., Ellis, B.S., Holzer, T.L. (2007). *Predicting shear-wave velocity from cone penetration resistance*. In Proc. 4th Int. Conf. Earthquake Geotechnical Engineering, Thessaloniki, Greece, Paper 1454.
- Brandenberg, S. J., Bellana, N., Shantz, T. (2010). "Shear wave velocity as function of standard penetration test resistance and vertical effective stress at California bridge sites." *Soil Dynamics and Earthquake Engineering*, 30, 1026-1035.
- Dickenson, SA (1994). *The dynamic response of soft and deep cohesive soils during the Loma Prieta earthquake of October 17, 1989*. Ph.D. Dissertation, Univ. California, Berkeley.
- Dobry, R., Borcherdt, R. D., Crouse, C. B., Idriss, I. M., Joyner, W. B., Martin, G. R., et al. (2000). "New site coefficients and site classification system used in recent building seismic code provisions." *Earthq. Spectra*, 16(1), 41–67.
- Federal Emergency Management Agency, (FEMA). (2001). "NEHRP recommended provisions for seismic regulations for new buildings and other structures ." *FEMA 368*. Building Seismic Safety Council for FEMA, Washington, DC.
- Fumal, T.E., Tinsley, J.C. (1985). "Mapping shear wave velocities of near surface geologic materials." *Prof. Paper 1360*, US Geological Survey.
- Gingery, G.R., Elgamal, A., Bray, J.D. (2015). "Response spectra at liquefaction sites during shallow crustal earthquakes." *Earthquake Spectra*, 31, 2325-2349.
- Hegazy, Y.A. and Mayne, P.W. (2006). "A global statistical correlation between shear wave velocity and cone penetration data." *Site and Geomaterial Characterization, GSP 149*, 243-248.
- Kwak, D.Y., Brandenberg, S.J., Mikami, A., Stewart, J.P. (2015). "Prediction equations for estimating shear-wave velocity from combined geotechnical and geomorphic indexes based on Japanese data set." *Bull. Seism. Soc. Am.*, 105, 1919-1930.
- Kwak, D.Y., Ancheta, T.D., Mitra, D., Ahdi, S.K., Zimmaro, P., Parker, G.A., Brandenberg, S.J. Stewart, J.P. (2017). *Performance evaluation of V_{SZ} -to- V_{S30} correlation methods using global V_S profile database*, Proc. 3rd Int. Conf. on Performance-Based Design in Earthquake Geotechnical Engineering, M Taiebat, D Wijewickreme, A Athanasopoulos-Zekkos, and RW Boulanger (editors), Paper No. 399, Vancouver, BC.
- McGann, C.R., Bradley, B.A., Taylor, M.L., Wotherspoon, L.M., Cubrinovski, M. (2015). "Development of an empirical correlation for predicting shear wave velocity of Christchurch soils from cone penetration test data." *Soil Dynamics and Earthquake Engineering*, 75, 66-75.
- National Cooperative Highway Research Program, NCHRP. (2012). "Practices and procedures for site-specific evaluations of earthquake ground motions," *Synthesis 428* (N Matasovic and YMA Hashash), Transportation Research Board, Washington, D.C.
- Robertson, P.K. (1990). "Soil classification using the cone penetration test." *Can. Geotech. J.*, 27, 151-158.

- Rodriguez-Marek, A., Rathje, E.M., Bommer, J.J., Scherbaum, F., and Stafford, P.J. (2014). “Application of single-station sigma and site response characterization in a probabilistic seismic hazard analysis for a new nuclear site.” *Bull. Seismol. Soc. Am.*, 104, 1601–1619.
- Rollins, KM, Evans, M.D., Diehl, N.B., Daily, W.D. (1998). “Shear modulus and damping relationships for gravels,” *J. Geotech. & Geoenviron. Eng.*, 124, 396-405.
- Stewart, J.P., Afshari, K., Hashash, Y.M.A. (2014). *Guidelines for performing hazard-consistent one-dimensional ground response analysis for ground motion prediction*, PEER Report 2014/16, Pacific Earthquake Engineering Research Center, UC Berkeley, CA.
- Stewart, J.P., Afshari, K., Goulet, C.A. (2017). “Non-ergodic site response in seismic hazard analysis,” *Earthquake Spectra*, 33, 1385-1414.
- Youd, T.L., Carter, B.L. (2005). “Influence of soil softening and liquefaction on spectral acceleration.” *J. Geotech. Geoenv. Eng.*, 131(7), 811-825.

COMMENTARY TO CHAPTER 21, SITE-SPECIFIC GROUND MOTION PROCEDURES FOR SEISMIC DESIGN

C21.0 GENERAL

Site-specific procedures for computing earthquake ground motions include dynamic site response analyses and probabilistic and deterministic seismic hazard analyses (PSHA and DSHA), which may include dynamic site response analysis as part of the calculation. Use of site-specific procedures may be required in lieu of the general procedure in Sections 11.4.2 through 11.4.7; Section C11.4.8 in ASCE 7-16 explains the conditions under which the use of these procedures is required. Such studies must be comprehensive and must incorporate current scientific interpretations. Because there is typically more than one scientifically credible alternative for models and parameter values used to characterize seismic sources and ground motions, it is important to formally incorporate these uncertainties in a site-specific analysis. For example, uncertainties may exist in seismic source location, extent, and geometry; maximum earthquake magnitude; earthquake recurrence rate; ground motion attenuation; local site conditions, including soil layering and dynamic soil properties; and possible two- or three-dimensional wave-propagation effects. The use of peer review for a site-specific ground motion analysis is encouraged.

Site-specific ground motion analysis can consist of one of the following approaches: (a) PSHA and possibly DSHA if the site is near an active fault, (b) PSHA/DSHA followed by dynamic site response analysis, and (c) dynamic site response analysis only. The first approach is used to compute ground motions for bedrock or stiff soil conditions (not softer than Site Class D). In this approach, if the site consists of stiff soil overlying bedrock, for example, the analyst has the option of either (a) computing the bedrock motion from the PSHA/DSHA and then using the site coefficient (F_a and F_v) tables in Section 11.4.3 to adjust for the stiff soil overburden or (b) computing the response spectrum at the ground surface directly from the PSHA/DSHA. The latter requires the use of attenuation equations for computing stiff soil-site response spectra (instead of bedrock response spectra).

The second approach is used where softer soils overlie the bedrock or stiff soils. The third approach assumes that a site-specific PSHA/DSHA is not necessary but that a dynamic site response analysis should or must be performed. This analysis requires the definition of an outcrop ground motion, which can be based on the 5% damped response spectrum computed from the PSHA/DSHA or obtained from the general procedure in Section 11.4. A representative set of acceleration time histories is selected and scaled to be compatible with this outcrop spectrum. Dynamic site response analyses using these acceleration histories as input are used to compute motions at the ground surface. The response spectra of these surface motions are used to define a maximum considered earthquake (MCE) ground motion response spectrum.

The approaches described in the aforementioned have advantages and disadvantages. In many cases, user preference governs the selection, but geotechnical conditions at the site may dictate the use of one approach over the other. If bedrock is at a depth much greater than the extent of the site geotechnical investigations, the direct approach of computing the ground surface motion in the PSHA/DSHA may be more reasonable. On the other hand, if bedrock is shallow and a large impedance contrast exists between it and the overlying soil (i.e., density times shear wave velocity of bedrock is much greater than that of the soil), the two-step approach might be more appropriate.

Use of peak ground acceleration as the anchor for a generalized site-dependent response spectrum is discouraged because sufficiently robust ground motion attenuation relations are available for computing response spectra in western U.S. and eastern U.S. tectonic environments.

C21.1 SITE RESPONSE ANALYSIS

C21.1.1 Base Ground Motions.

Ground motion acceleration histories that are representative of horizontal rock motions at the site are required as input to the soil model. Where a site-specific ground motion hazard analysis is not performed, the MCE_R base response spectrum is developed assuming a site condition representative of base-condition average shear wave velocity, v_{s30} . The U.S. Geological Survey (USGS) national seismic hazard mapping project website (<https://doi.org/10.5066/F7HT2MHG>) includes hazard deaggregation options that can be used to evaluate the predominant types of earthquake sources, magnitudes, and distances contributing to the probabilistic ground motion hazard. Sources of recorded acceleration time histories include the databases of the Consortium of Organizations for Strong Motion Observation Systems (COSMOS) Virtual Data Center website (www.cosmos-eq.org), the Pacific Earthquake Engineering Research (PEER) Center Strong Motion Database website (peer.berkeley.edu/products/strong_ground_motion_db.html), and the U.S. National Center for Engineering Strong Motion Data (NCESMD) website (<http://www.strongmotioncenter.org>). Ground motion acceleration histories at these sites generally were recorded at the ground surface and hence apply for an outcropping condition and should be specified as such in the input to the site response analysis code (Kwok et al. 2007 have additional details).

C21.1.2 Site Condition Modeling.

Modeling criteria are established by site-specific geotechnical investigations that should include (a) borings with sampling; (b) standard penetration tests (SPTs), cone penetrometer tests (CPTs), and/or other subsurface investigative techniques; and (c) laboratory testing to establish the soil types, properties, and layering. The depth to rock or stiff soil material should be established from these investigations. Investigation should extend to bedrock or, for very deep soil profiles, to material in which the model is terminated. Although it is preferable to measure shear wave velocities in all soil layers, it is also possible to estimate shear wave velocities based on measurements available for similar soils in the local area or through correlations with soil types and properties. A number of such correlations are summarized by Kramer (1996).

Typically, a one-dimensional soil column extending from the ground surface to bedrock is adequate to capture first-order site response characteristics. For very deep soils, the model of the soil columns may extend to very stiff or very dense soils at depth in the column. Two- or three-dimensional models should be considered for critical projects when two- or three-dimensional wave propagation effects may be significant (for example, sloping ground sites). The soil layers in a one-dimensional model are characterized by their total unit weights and shear wave velocities from which low-strain (maximum) shear moduli may be obtained and by relationships defining the nonlinear shear stress–strain behavior of the soils. The required relationships for analysis are often in the form of curves that describe the variation of soil shear modulus with shear strain (modulus reduction curves) and by curves that describe the variation of soil damping with shear strain (damping curves). In a two- or three-dimensional model, compression wave velocities or moduli or Poisson ratios also are required. In an analysis to estimate the effects of liquefaction on soil site response, the nonlinear soil model also must incorporate the buildup of soil pore water pressures and the consequent reductions of soil stiffness and strength. Typically, modulus reduction curves and damping curves are selected on the basis of published relationships for similar soils (for example, Vucetic and Dobry 1991, Electric Power Research Institute 1993, Darendeli 2001, Menq 2003, and Zhang et al. 2005). Site-specific laboratory dynamic tests on soil samples to establish nonlinear soil characteristics can be considered where published relationships are judged to be inadequate for the types of soils present at the site. Shear and compression wave velocities and associated maximum moduli should be selected based on field tests to determine these parameters or, if such tests are not possible, on published relationships and experience for similar soils in the local area. The uncertainty in the selected maximum shear moduli, modulus reduction and damping curves, and other soil properties should be estimated (Darendeli 2001,

Zhang et al. 2008). Consideration of the ranges of stiffness prescribed in Section 12.13.3 (increasing and decreasing by 50%) is recommended.

C21.1.3 Site Response Analysis and Computed Results.

Analytical methods may be equivalently linear or nonlinear. Frequently used computer programs for one-dimensional analysis include the equivalent linear program SHAKE (Schnabel et al. 1972, Idriss and Sun 1992) and the nonlinear programs FLAC (Itasca 2005); DESRA-2 (Lee and Finn 1978); MARDES (Chang et al. 1991); SUMDES (Li et al. 1992); D-MOD_2 (Matasovic 2006); DEEPSOIL (Hashash and Park 2001); TESS (Pyke 2000); and OpenSees (Ragheb 1994, Parra 1996, and Yang 2000). If the soil response induces large strains in the soil (such as for high acceleration levels and soft soils), nonlinear programs may be preferable to equivalent linear programs. For analysis of liquefaction effects on site response, computer programs that incorporate pore water pressure development (effective stress analyses) should be used (for example, FLAC, DESRA-2, SUMDES, D-MOD_2, TESS, DEEPSOIL, and OpenSees). Response spectra of output motions at the ground surface are calculated as the ratios of response spectra of ground surface motions to input outcropping rock motions. Typically, an average of the response spectral ratio curves is obtained and multiplied by the input MCE response spectrum to obtain the MCE ground surface response spectrum. Alternatively, the results of site response analyses can be used as part of the PSHA using procedures described by Goulet et al. (2007) and programmed for use in OpenSHA (www.opensha.org; Field et al. 2005). Sensitivity analyses to evaluate effects of soil-property uncertainties should be conducted and considered in developing the final MCE response spectrum.

C21.2 RISK-TARGETED MAXIMUM CONSIDERED EARTHQUAKE (MCE_R) GROUND MOTION HAZARD ANALYSIS

Site-specific risk-targeted maximum considered earthquake (MCE_R) ground motions are based on separate calculations of site-specific probabilistic and site-specific deterministic ground motions.

Both the probabilistic and deterministic ground motions are defined in terms of 5% damped spectral response in the maximum direction of horizontal response. The maximum direction in the horizontal plane is considered the appropriate ground motion intensity parameter for seismic design using the equivalent lateral force (ELF) procedure of Section 12.8 with the primary intent of avoiding collapse of the structural system.

Most ground motion relations are defined in terms of average (geometric mean) horizontal response. Maximum response in the horizontal plane is greater than average response by an amount that varies with period. Maximum response may be reasonably estimated by factoring average response by period-dependent factors of 1.2 at periods less than or equal to 0.2 s, by 1.25 for a period of 1.0 s, and by 1.3 for periods greater than or equal to 10 s (Resource Paper 4 of the 2015 NEHRP Provisions, which is based on Shahi and Baker, 2013). The maximum direction was adopted as the ground motion intensity parameter for use in seismic design in lieu of explicit consideration of directional effects.

C21.2.1 Probabilistic (MCE_R) Ground Motions.

Probabilistic seismic hazard analysis (PSHA) methods and subsequent computations of risk-targeted probabilistic ground motions based on the output of PSHA are sufficient to define (MCE_R) ground motion at all locations except those near highly active faults. Descriptions of current PSHA methods can be found in McGuire (2004). The primary output of PSHA methods is a so-called hazard curve, which provides mean annual frequencies of exceeding various user-specified ground motion amplitudes. Risk-targeted probabilistic ground motions are derived from hazard curves as described in Luco et al. (2007). Summarizing, the hazard curve is combined with a collapse fragility (or probability distribution of the ground motion amplitude that causes collapse) that depends on the risk-targeted probabilistic ground motion itself. The combination quantifies the risk of collapse. Iteratively, the risk-targeted probabilistic ground motion is modified until combination of the corresponding collapse fragility with the hazard curve results

in a risk of collapse of 1% in 50 years. This target is based on the average collapse risk across the western United States that is expected to result from design for the probabilistic MCE ground motions in ASCE 7.

C21.2.2 Deterministic (MCE_R) Ground Motions.

ASCE 7-16 and prior editions stated that “the largest ... acceleration for the characteristic earthquakes on all known active faults ... shall be used.” The concept of “characteristic earthquakes” is not included in the version of the Uniform California Earthquake Rupture Forecast that is used for the MCE_R and MCE_G ground motion maps of these Provisions (i.e., “UCERF3” by the Working Group on California Earthquake Probabilities, 2013). Characteristic earthquakes are no longer specified because they are considered to be inconsistent with recent earthquakes such as the 2010 Baja California event. Accordingly, in the definition of deterministic ground motions in these Provisions, the requirement for characteristic earthquakes has been replaced by “scenario earthquakes” that are determined from hazard deaggregations for the probabilistic ground motions at the site. At each spectral response period, the deaggregation provides a mean earthquake magnitude for each fault, which is termed a scenario earthquake. These scenario earthquakes average over all of the magnitudes that could occur on each fault. This is in contrast to the single magnitude that needed to be chosen for each of the characteristic earthquakes called for in ASCE 7-16. Examples of scenario earthquakes from hazard deaggregations are given in Table C21.2.2-1

Table C21.2.2-1 Examples of scenario earthquake from hazard deaggregations at a site in San Jose, California

Period T (s)	Scenario Earthquake							
	Hayward		Calaveras		San Andreas		Silver Creek	
	M	Contribution	M	Contribution	M	Contribution	M	Contribution
0.20	7.0	53%	7.2	16%	7.9	11%	6.9	3%
0.25	7.0	52%	7.2	16%	7.9	12%	6.9	3%
0.30	7.0	52%	7.2	16%	7.9	13%	6.9	3%
0.40	7.0	52%	7.2	16%	7.9	15%	7.0	3%
0.50	7.0	51%	7.3	16%	7.9	16%	7.0	3%
0.75	7.1	49%	7.3	16%	7.9	19%	7.0	3%
1.0	7.1	48%	7.3	16%	7.9	20%	7.1	2%
1.5	7.1	43%	7.3	16%	8.0	24%	7.1	1%
2.0	7.2	39%	7.3	16%	8.0	27%	7.2	1%
3.0	7.2	34%	7.4	15%	8.0	34%	7.2	1%
4.0	7.3	29%	7.4	14%	8.0	40%	NA	<1%
5.0	7.4	24%	7.4	13%	8.0	44%	NA	<1%

Whereas ASCE 7-16 stipulated “active” faults, albeit without a definition, these Provisions instead specify that scenario earthquakes contributing less than 10% of the largest contributor at each period shall be ignored. The contribution of each scenario earthquake is an output of the same hazard deaggregations used

to determine the earthquake magnitudes. In effect, this specification defines what constitutes an active fault, in a way that ensures that deterministic ground motions are only calculated for faults contributing significantly for the probabilistic ground motions at the site. For example, at the San Jose site considered in Table C21.2.2-1, deterministic ground motions (at spectral response periods from 0.20 to 5.0 seconds) would be calculated for the Hayward, Calaveras, and San Andreas faults, but not for the Silver Creek fault.

For consistency, the same attenuation equations and ground motion variability used in the PSHA should be used in the deterministic seismic hazard analysis (DSHA). Adjustments for directivity and/or directional effects should also be made, when appropriate. In some cases, ground motion simulation methods may be appropriate for the estimation of long-period motions at sites in deep sedimentary basins or from great ($M \geq 8$) or giant ($M \geq 9$) earthquakes, for which recorded ground motion data are lacking.

Deterministic (MCE_R) ground motions are taken as the greater of those calculated for the site of interest and the deterministic lower limit MCE_R ground motions of Table 21.2-1 (i.e., a “lower limit” below which deterministic ground motions are not required for design). Table 21.2-1 defines lower limit MCE_R deterministic ground motions in terms of multi-period spectra for the site-specific value of Site Class. These response spectra represent 84th percentile ground motions of a magnitude M8.0 shallow crustal earthquake at a distance of about 12.5 km from fault rupture (FEMA, 2020). These fault properties were selected such that short-period (0.2-second) and 1.0-second response spectral accelerations for Site Class BC, 1.5 g and 0.6 g, would be the same as the values of the spectral parameters, $1.5F_a$ (g) and $0.6F_v/T$ (g), of the two-period lower limit deterministic MCE_R response spectrum of Figure 12.2-1 of ASCE 7-16.

Where the probabilistic MCE_R ground motions (Section 21.2.1) are less than the deterministic lower limit MCE_R ground motions of Table 21.2-1 for the site class of interest, at all response periods, probabilistic MCE_R ground motions govern at the site of interest and deterministic MCE_R ground motions need not be calculated. Such is typically the case for sites in the Central and Eastern U.S.

C21.2.3 Site-Specific MCE_R .

Because of the deterministic lower limit on the MCE_R spectrum (Table 21.2-1), the site-specific MCE_R ground motion is equal to the corresponding risk-targeted probabilistic ground motion wherever it is less than the deterministic limit. Where the probabilistic ground motions are greater than the lower limits, the deterministic ground motions sometimes govern, but only if they are less than their probabilistic counterparts. The deterministic ground motions govern mainly near major faults in California (like the San Andreas).

The site-specific MCE_R response spectrum may be taken as equal to the MCE_R response spectrum obtained from the USGS web service without performing site-specific calculations and cannot be taken as less than 80% of the MCE_R response spectrum obtained from the USGS web service. These requirements recognize the considerable earthquake hazard and ground motion expertise of the USGS and rely on the MCE_R ground motions available from the USGS (1) to provide an acceptable alternative to calculating site-specific ground motions (which can be a burden for smaller projects), and (2) to establish a “safety net” on site-specific ground motions.

80% of the MCE_R response spectrum obtained from the USGS web service—was established as the lower limit to prevent the possibility of site-specific studies generating unreasonably low ground motions from potential misapplication of site-specific procedures or misinterpretation or mistakes in the quantification of the basic inputs to these procedures. Even if site-specific studies were correctly performed and resulted in ground motion response spectra less than the 80% lower limit, the uncertainty in the seismic potential and ground motion attenuation across the United States was recognized in setting this limit. Under these circumstances, the allowance of up to a 20% reduction in the design response spectrum based on site-specific studies was considered reasonable.

Although the 80% lower limit is reasonable for sites not classified as Site Class F, an exception has been introduced at the end of this section to permit a site class other than E to be used in establishing this limit

when a site is classified as F. This revision eliminates the possibility of an overly conservative design spectrum on sites that would normally be classified as Site Class C or D.

C21.3 DESIGN RESPONSE SPECTRUM

The site-specific design response spectrum is defined as two-thirds of the site-specific MCE_R response spectrum consistent with the requirements of Section 11.5.4.1.

C21.4 DESIGN ACCELERATION PARAMETERS

The S_{DS} criteria of Section 21.4 are based on the premise that the value of the parameter S_{DS} should be taken as 90% of the peak value of site-specific response spectral acceleration regardless of the period (greater than or equal to 0.2 s) at which the peak value of response spectral acceleration occurs. Consideration of periods beyond 0.2 s recognizes that site-specific studies (e.g., softer site conditions) can produce response spectra with ordinates at periods greater than 0.2 s that are significantly greater than those at 0.2 s. Periods less than 0.2 s are excluded for consistency with the 0.2-s period definition of the short-period ground motion parameter S_S , and recognizing that certain sites, such as Central and Eastern United States (CEUS) sites, could have peak response at very short periods that would be inappropriate for defining the value of the parameter S_{DS} . The upper bound limit of 5 s precludes unnecessary checking of response at periods that cannot govern the peak value of site-specific response spectral acceleration. 90% (rather than 100%) of the peak value of site-specific response spectral acceleration is considered appropriate for defining the parameter S_{DS} (and the domain of constant acceleration) since most short-period structures have a design period that is not at or near the period of peak response spectral acceleration. Away from the period of peak response, response spectral accelerations are less, and the domain of constant acceleration is adequately described by 90% of the peak value. For those short-period structures with a design period at or near the period of peak response spectral acceleration, anticipated yielding of the structure during MCE_R ground motions effectively lengthens the period and shifts dynamic response to longer periods at which spectral demand is always less than that at the peak of the spectrum.

The S_{DI} criteria of Section 21.4 are based on the premise that the value of the parameter S_{DI} should be taken as the larger of (1) 100% of the response at 1 s and (2) 90% of maximum value of the product $T \cdot S_a$ for a period range, $1 \text{ s} \leq T \leq 2 \text{ s}$, for stiffer sites $\bar{v}_s > 1,450 \text{ ft/s}$ ($\bar{v}_s > 442 \text{ m/s}$) and for a period range, $1 \text{ s} \leq T \leq 5 \text{ s}$, for softer sites $\bar{v}_s \leq 1,450 \text{ ft/s}$ ($\bar{v}_s \leq 442 \text{ m/s}$), which are expected to have peak values of response spectral velocity at periods greater than 2 s. The criteria use the maximum value of the product $T \cdot S_a$ over the period range of interest to effectively identify the period at which the peak value of response spectral velocity occurs. Consideration of periods beyond 1 s accounts for the possibility that the assumed $1/T$ proportionality for the constant velocity portion of the design response spectrum begins at periods greater than 1 s or is actually $1/T^n$ (where $n < 1$). Periods less than 1 s are excluded for consistency with the definition of the 1-s ground motion parameter, S_I . Peak velocity response is expected to occur at periods less than or equal to 5 s, and periods beyond 5 s are excluded by the criteria to avoid potential misuse of very long period ground motions that may not be reliable. 90% of the peak value of site-specific response spectral acceleration at the period of peak velocity response is considered appropriate for defining the value of the parameter S_{DI} for sites where ground motions have peak velocity response significantly beyond 1 s (e.g., sites whose hazard is governed by larger magnitude earthquakes). For these sites, away from the period of peak velocity response, response spectral acceleration is less than that of the assumed $1/T$ shape and the domain of constant velocity is adequately described by 90% of the response at the period of peak velocity response. 100% of 1-s response is considered appropriate for defining the value of the parameter S_{DI} for sites where ground motions have peak velocity response at or near 1 s (e.g., sites whose hazard is governed by smaller magnitude earthquakes). For these sites, at periods beyond 1 s response spectral acceleration is typically similar to that of the assumed $1/T$ shape and the domain of constant velocity would not be adequately described by less than 100% of 1-s response.

C21.5 MAXIMUM CONSIDERED EARTHQUAKE GEOMETRIC MEAN (MCE_G) PEAK GROUND ACCELERATION

Site-specific requirements for determination of peak ground acceleration (PGA) are provided in Section 21.5 that are parallel to the procedures for developing site-specific response spectra in Section 21.2. The site-specific MCE peak ground acceleration, $PGAM$, is taken as the lesser of the probabilistic geometric mean peak ground acceleration of Section 21.5.1 and the deterministic geometric mean peak ground acceleration of Section 21.5.2. Similar to the provisions for site-specific spectra, a deterministic lower limit is prescribed for $PGAM$ with the intent to limit application of deterministic ground motions to the site regions containing active faults where probabilistic ground motions are relatively high. However, consistent with the lower limit of ASCE 7-16 (e.g., $0.5 F_{PGA}$), the deterministic lower limit for $PGAM$ (in g) is set at a lower value (e.g., $PGA_G = 0.5$ for Site Class BC, Table 21.2-1), than the value set for the zero-period response spectral acceleration (e.g., $PGA_G = 0.66$ for Site Class BC, Table 21.2-1). The rationale for the value of the lower deterministic limit for spectra is based on the desire to limit minimum spectral values, for structural design purposes, to the values given by the 1997 Uniform Building Code (UBC) for Zone 4 (multiplied by a factor of 1.5 to adjust to the MCE level). This rationale is not applicable to $PGAM$ for geotechnical applications, and therefore a lower value was selected. Section 21.5.3 states that the site-specific MCE peak ground acceleration cannot be less than 80% the value of $PGAM$ obtained from the USGS web service. The 80% limit is a long-standing base for site-specific analyses in recognition of the uncertainties and limitations associated with the various components of a site-specific evaluation.

REFERENCES

- Chang, C.-Y., Mok, C. M., Power, M. S., and Tang, Y. K. (1991). "Analysis of ground response at lotung large-scale soil-structure interaction experiment site." *Report NP-7306-SL*. EPRI, Palo Alto, Calif.
- Darendeli, M. (2001). *Development of a new family of normalized modulus reduction and material damping curves*. Ph.D. Dissertation, Department of Civil Engineering, University of Texas, Austin.
- Electric Power Research Institute (EPRI). (1993). "Guidelines for determining design basis ground motions." *Report EPRI TR-102293*. EPRI, Palo Alto, CA.
- FEMA. (2020). "Procedures for developing multi-period response spectra at non-conterminous united states sites." *FEMA P-2078*, Washington, D.C.
- Field, E. H., Gupta, N., Gupta, V., Blanpied, M., Maechling, P., and Jordan, T. H. (2005). "Hazard calculations for the WGCEP-2002 forecast using OpenSHA and distributed object technologies." *Seismol. Res. Lett.*, 76, 161–167.
- Goulet, C. A., Stewart, J. P., Bazzurro, P., and Field, E. H. (2007). *Integration of site-specific ground response analysis results into probabilistic seismic hazard analyses*. Paper 1486, Proc., 4th Intl. Conference on Earthquake Geotechnical Engineering, Thessaloniki, Greece, CRC Press, Boca Raton, FL.
- Hashash, Y. M. A., and Park, D. (2001). "Non-linear one-dimensional seismic ground motion propagation in the Mississippi embayment." *Engrg. Geol.*, 62(1-3), 185–206.
- Idriss, I. M., and Sun, J. I. (1992). *User's manual for SHAKE91*. Center for Geotechnical Modeling, Department of Civil and Environmental Engineering, University of California, Davis.
- Itasca Consulting Group. (2005). *FLAC, Fast Lagrangian Analysis of Continua*, v. 5.0. Itasca Consulting Group, Minneapolis, MN.
- Kramer, S. L. (1996). *Geotechnical earthquake engineering*, Prentice-Hall, Englewood Cliffs, NJ.

- Kwok, A. O. L., Stewart, J. P., Hashash, Y. M. A., Matasovic, N., Pyke, R., Wang, Z., et al. (2007). "Use of exact solutions of wave propagation problems to guide implementation of nonlinear seismic ground response analysis procedures." *J. Geotech. Geoenviron. Engrg.* 133(11), 1385–1398.
- Lee, M. K. W., and Finn, W. D. L. (1978). *DESRA-2, Dynamic effective stress response analysis of soil deposits with energy transmitting boundary including assessment of liquefaction potential*, Soil Mechanics Series 36, Department of Civil Engineering, University of British Columbia, Vancouver.
- Li, X. S., Wang, Z. L., and Shen, C. K. (1992). *SUMDES, a nonlinear procedure for response analysis of horizontally-layered sites subjected to multi-directional earthquake loading*. Department of Civil Engineering, University of California, Davis.
- Luco, N., Ellingwood, B. R., Hamburger, R. O., Hooper, J. D., Kimball, J. K., and Kircher, C. A. (2007). *Risk-targeted versus current seismic design maps for the conterminous United States*. Proc. SEAOC 76th Annual Convention. Structural Engineers Association of California, Sacramento, CA.
- Matasovic, N. (2006). *D-MOD_2—A computer program for seismic response analysis of horizontally layered soil deposits, earthfill dams, and solid waste landfills*. User's manual, GeoMotions, LLC, Lacey, WA, 20 (plus Appendices).
- McGuire, R. K. (2004). "Seismic hazard and risk analysis," *Monograph, MNO-10*. Earthquake Engineering Research Institute, Oakland, CA, 221.
- Menq, F. (2003). *Dynamic properties of sandy and gravelly soils*. Ph.D. Dissertation, Department of Civil Engineering, University of Texas, Austin.
- Parra, E. (1996). *Numerical modeling of liquefaction and lateral ground deformation including cyclic mobility and dilation response in soil systems*. Ph.D. Dissertation, Department of Civil Engineering, Rensselaer Polytechnic Institute, Troy, NY.
- Pyke, R. M. (2000). *TESS: A computer program for nonlinear ground response analyses*. TAGA Engineering Systems & Software, Lafayette, CA.
- Ragheb, A. M. (1994). *Numerical analysis of seismically induced deformations in saturated granular soil strata*. Ph.D. Dissertation, Department of Civil Engineering, Rensselaer Polytechnic Institute, Troy, NY.
- Schnabel, P. B., Lysmer, J., and Seed, H. B. (1972). "SHAKE: A Computer program for earthquake response analysis of horizontally layered sites," *Report EERC 72-12*, Earthquake Engineering Research Center, University of California, Berkeley.
- Shahi, S. K., and Baker, J. W. (2013). *NGA-West2 models for ground-motion directionality*, PEER Report 2013/10, Pacific Earthquake Engineering Research Center, University of California, Berkeley, May 2013.
- Vucetic, M., and Dobry, R. (1991). "Effect of soil plasticity on cyclic response." *J. Geotech. Engrg.*, 117(1), 89–107.
- Working Group on California Earthquake Probabilities (WGCEP). (2013). "Uniform California earthquake rupture forecast, v. 3 (UCERF3)—The time-independent model." *USGS Open File Report 2013-1165*.
- Yang, Z. (2000). *Numerical modeling of earthquake site response including dilation and liquefaction*. Ph.D. Dissertation, Department of Civil Engineering and Engineering Mech., Columbia University, New York.
- Zhang, J., Andrus, R. D., and Juang, C. H. (2005). "Normalized shear modulus and material damping ratio relationships." *J. Geotech. Geoenviron. Engrg.*, 131(4), 453–464.

Zhang, J., Andrus, R. D., and Juang, C. H. (2008). "Model uncertainty in normalized shear modulus and damping relationships." *J. Geotech. Geoenviron. Engrg.*, 134(1), 24–36.

OTHER REFERENCES (NOT CITED)

Abrahamson, N. A. (2000). *Effects of rupture directivity on probabilistic seismic hazard analysis*. Proc. 6th Intl. Conference on Seismic Zonation, Earthquake Engineering Research Institute, Oakland, CA.

Huang, Y.-N., Whittaker, A. S., and Luco, N. (2008). "Maximum spectral demands in the near-fault region." *Earthq. Spectra*, 24(1), 319–341.

Kircher, C. A. (2015). *Investigation of an identified short-coming in the seismic design procedures of ASCE 7-16 and development of recommended improvements for ASCE 7-16*, prepared for Building Seismic Safety Council, National Institute of Building Sciences, Washington, DC, prepared by Kircher & Associates, Consulting Engineers, Palo Alto, CA, March 15, 2015. https://c.ymcdn.com/sites/www.nibs.org/resource/resmgr/BSSC2/Seismic_Factor_Study.pdf

Somerville, P. G., Smith, N. F., Graves, R. W., and Abrahamson, N. A. (1997). "Modification of empirical strong ground motion attenuation relations to include the amplitude and duration effects of rupture directivity." *Seismol. Res. Lett.*, 68, 199–222.

Page intentionally left blank.

COMMENTARY TO CHAPTER 22, SEISMIC GROUND MOTION AND LONG-PERIOD TRANSITION MAPS

These *Provisions* continue to contain risk-targeted maximum considered earthquake (MCE_R) spectral response acceleration maps (Figs. 22-1 through 22-8) and maximum considered earthquake geometric mean (MCE_G) peak ground acceleration maps (Figs. 22-9 through 22-13), both introduced in the 2009 *NEHRP Provisions* and *ASCE/SEI 7-10*. Long-period transition period (T_L) maps are also provided (Figs. 22-14 through 22-17), as introduced in *ASCE/SEI 7-05*. The MCE_R and MCE_G maps, but not T_L maps, are updated with respect to those in *ASCE/SEI 7-16*, based on recommendations of an effort referred to as “Project ‘17” (BSSC, 2019) and on the 2018 U.S. Geological Survey (USGS) National Seismic Hazard Model (NSHM). Furthermore, the risk coefficient maps of *ASCE/SEI 7-16* have been removed, for consistency with the revised site-specific ground motion procedures of Section 21.2.1 of these *Provisions*. The updates to the MCE_R and MCE_G maps are summarized in the subsections below, followed by a summary of map-development details and a description of USGS resources for retrieving Chapter 22 values.

Modifications to MCE_R and MCE_G ground motions from Project ‘17 recommendations:

Project ‘17 was a collaboration between the Building Seismic Safety Council (BSSC), with funding from the Federal Emergency Management Agency, and the USGS. The project focused on improvements to the seismic maps of *ASCE/SEI 7-16* for these *Provisions*, and resulted in recommendations documented in (BSSC, 2019). The recommendations led to the four modifications to the MCE_R and/or MCE_G ground motions summarized here. Examples of the resulting changes to the MCE_R and MCE_G values are given in subsequent subsections.

1. Whereas *ASCE/SEI 7-16* (and earlier editions back to *ASCE/SEI 7-98*) calculated MCE_R and MCE_G ground motions for each site class (S_{MS} , S_{MI} , and PGA_M) by adjusting mapped ground motions (S_S , S_I , and PGA) with site coefficients (F_a , F_v , and F_{PGA}), these *Provisions* provide S_{MS} , S_{MI} , and PGA_M values that come directly from the USGS NSHM (or an interim approximation outside of the conterminous United States). In effect, this changes the site class effects. The changes are most significant in the eastern United States, because the prior *ASCE/SEI 7-16* site coefficients were based on western United States data and simulations (Seyhan & Stewart, 2014; Kircher & Associates, 2015). Note that rather than providing maps of S_{MS} , S_{MI} , and PGA_M for all of the site classes, these *Provisions* provide maps for the default site class and an online USGS Seismic Design Geodatabase archive for the other site classes. Although S_S , S_I , and PGA are no longer needed to calculate S_{MS} , S_{MI} , and PGA_M , values of S_S and S_I are also contained in the USGS Seismic Design Geodatabase for use elsewhere in these *Provisions* (e.g., for seismic design category).
2. Whereas the S_{MS} and S_{MI} spectral response accelerations of *ASCE/SEI 7-16* (and back to *ASCE/SEI 7-98*) were at the same periods as the previously mapped MCE_R ground motions (S_S and S_I), namely 0.2 and 1.0 seconds, these *Provisions* adhere to the definitions of S_{MS} and S_{MI} in Chapter 21 (Section 21.4), which consider ranges of periods. Like the ground motions for each site class (discussed above), the spectral response accelerations at the range of periods come directly from the USGS NSHM (or an interim approximation outside of the conterminous United States). In general, this modification to the periods considered increases S_{MI} values at locations where relatively frequent, large-magnitude crustal earthquakes dominate the seismic hazard. The impact on S_{MS} values is generally smaller.
3. Whereas the deterministic caps considered for the MCE_R and MCE_G ground motions of *ASCE/SEI 7-16* (and back to *ASCE/SEI 7-98*) were from “characteristic earthquakes on all known active faults,” these *Provisions* call for scenario earthquakes from hazard deaggregation, as explained in the

commentary of Chapter 21 (Section C21.2.2). For each earthquake, the way in which the 84th-percentile ground motion is calculated has also been modified. These deterministic ground motions are now approximated via so-called epsilons (corresponding to ground motion percentiles) from the same hazard deaggregations that determine the scenario earthquakes. Furthermore, these *Provisions* have modified the lower limits imposed on the deterministic ground motions, although they are anchored to the limits used for the *ASCE/SEI 7-16* MCE_R and MCE_G maps; see Section C21.2.2. Together, the three modifications to deterministic capping change the MCE_R and MCE_G values in the conterminous United States. Pending updates to the USGS NSHM for the other states and territories, there only the modification to the deterministic lower limits has been applied.

4. The maximum-response scale factors used for the MCE_R maps of *ASCE/SEI 7-16* (and *ASCE/SEI 7-10*) have been updated for these *Provisions*, adopting the proposal of Resource Paper 4 of the *2015 NEHRP Provisions*, which is based on (Shahi and Baker, 2013). Over the range of spectral response periods considered for the MCE_R ground motions of these *Provisions*, the change in the scale factors ranges from a 9% increase to a 15% decrease.

Table C22-1 charts which of these four modifications affect each of the MCE_R and MCE_G ground motion parameters (S_S , S_I , $PGAM$, S_{MS} , and S_{MI}). As mentioned above, the MCE_R and MCE_G ground motions outside of the conterminous United States do not yet incorporate the modifications to deterministic earthquakes and 84th-percentile ground motions, pending forthcoming USGS updates for those state and territories. Moreover, the modifications to site class effects and spectral periods are currently approximated outside of the conterminous United States, by means of a procedure documented in (FEMA, 2020)). For the MCE_R ground motions in Alaska, Hawaii, and Puerto Rico and the U.S. Virgin Islands, the collapse-fragility logarithmic standard deviation (or “beta value”) has also been updated, from 0.8 to 0.6 for consistency with the other states and territories.

Note: For international locations where a multi-period and multi-site-class hazard model is not available, and where the above-mentioned (FEMA, 2020) approximation is not applicable, a local or regional study could develop ground motions that are consistent with these *Provisions*.

Table C22-1 Modifications to MCE_R and MCE_G ground motions from *ASCE/SEI 7-16* to these *Provisions* based on Project '17 recommendations

Modification	Conterminous United States			Other States & Territories		
	S_S & S_I	$PGAM$	S_{MS} & S_{MI}	S_S & S_I	$PGAM$	S_{MS} & S_{MI}
1. Site class effects		X*	X*		X*	X*
2. Spectral periods			X			X
3a. Deterministic earthquakes	X	X	X			
3b. 84th-percentile calculation	X	X	X			
3c. Deterministic lower limits		X*	X*		X*	X*
4. Max-direction factors	X		X	X		X

* For Site Class BC, the site class effects and deterministic lower limits have not changed from *ASCE/SEI 7-16* to these *Provisions*.

Modifications to MCE_R and MCE_G ground motions from 2018 USGS NSHM update:

Whereas the MCE_R and MCE_G maps of *ASCE/SEI 7-16* were derived from the 2014 USGS National Seismic Hazard Model (NSHM; Petersen et al., 2014), the MCE_R and MCE_G ground motions of these *Provisions* are derived from the 2018 USGS NSHM. The four modifications in the 2018 NSHM, all for the conterminous United States, are summarized here. Details are presented in the documentation of the 2018 update (Petersen et al., 2020). Examples of the resulting changes to the values of MCE_R and MCE_G ground motions are given in the ensuing subsections.

1. For the central and eastern United States (CEUS), the ground motion models incorporated into the 2018 NSHM are from the NGA-East project of the Pacific Earthquake Engineering Research Center (PEER). This was a multi-year project funded by the U.S. Nuclear Regulatory Commission that gathered data applicable to the CEUS and developed models of median ground motions (PEER, 2015), site effects (Stewart et al, 2017), the random or aleatory variability in ground motions (e.g., Al Atik, 2015), and the epistemic uncertainty in median ground motions (Goulet et al., 2017). The NGA-East ground motion models have made it possible to produce NSHM spectral response accelerations in the CEUS for periods from 0 (for peak ground acceleration) to 10 seconds and for site classes A through E. The CEUS ground motion models used for the 2014 NSHM only included a relatively narrow range of periods and site classes. For these few periods and site classes, the ground motion values of the 2018 NSHM are larger at most, but not all CEUS locations. (Rezaeian et al., 2020).
2. In the Los Angeles, Seattle, San Francisco, and Salt Lake City regions—where there are published models that are deemed applicable (from, respectively, Lee et al., 2014; Stephenson et al., 2007; Aagaard et al., 2008; and Magistrale et al., 2008)—basin depths have been incorporated into the 2018 NSHM. The depths are input to the ground motion models used for the western United States, although in the Seattle region, this entails modification of the models for subduction zone earthquakes. At sites where the basin depths are relatively large (see Petersen et al., 2020 for details), there is scientific consensus that longer-period ground motions are amplified, based on observations and simulations. Thus, at these deeper-basin sites, the 2018 NSHM ground motions are amplified. The amount of amplification increases with basin depth and spectral response period; it decreases with site class (from A to E). At sites where the depths are relatively small, there is currently a lack of scientific consensus on basin effects. Thus, at these shallower-basin sites and outside of the four regions, a default basin depth that is estimated from site class (by each of the NGA-West2 ground motion models) is assumed in the 2018 NSHM, and ground motions are unaffected. In the 2014 NSHM, used for *ASCE/SEI 7-16*, the effects of deep basins were not included; only a relatively shallow default basin depth, corresponding to the BC site class of the 2014 NSHM, was considered.
3. Outside of California (because the Uniform California Earthquake Rupture Forecast, UCERF, has not been modified), the catalog of past earthquakes has been updated for the 2018 NSHM. Seismicity catalogs are used to calculate spatially smoothed rates of occurrence of future earthquakes on unmodeled (or unknown) faults. In addition to appending earthquakes that occurred in 2013 through 2017, other updates have been made to the catalog and the smoothed earthquake rates; please see (Petersen et al., 2020). The amount of change to the NSHM caused by these updates is generally smaller than the updates described above.
4. For the western United States, two of the ground motion models that were included in the 2014 NSHM have been excluded for the 2018 update. One of the two models cannot be used for softer site classes

(Idriss, 2014), and the other cannot be used for spectral response periods longer than 3.0 seconds (Atkinson and Boore, 2003 and 2008). For the harder site classes and shorter periods covered by these ground motion models, excluding them only slightly changes the NSHM by an amount that depends on location, spectral response period, and site class.

For the states and territories outside of the conterminous United States, the USGS NSHM has not been updated with respect to what was used for *ASCE/SEI 7-16*. There, changes to the MCE_R and MCE_G ground motions from *ASCE/SEI 7-16* to these *Provisions* are due to the Project '17 modifications summarized in the preceding subsection.

Examples of changes in MCE_R and MCE_G values

The combined impacts of the Project '17 and USGS NSHM modifications summarized above on MCE_R and MCE_G values are demonstrated in Tables C22-3 through C22-5 and Figures C22-1 through C22-3, for the 34 example locations listed in Table C22-2. These locations are the same as those considered in *ASCE/SEI 7-16*, which were first introduced in the *2009 NEHRP Provisions*. In the MCE_R and MCE_G tables and Figures, ground motions of these *Provisions* are compared with those from *ASCE/SEI 7-16* and *ASCE/SEI 7-10*. The S_{MS} , S_{MI} , and PG_{AM} ground motions are for the default site class, so that the comparisons capture the most common site class effects. Corresponding seismic design categories (SDCs) are compared in Table C22-6. For the locations where the SDCs have changed from *ASCE/SEI 7-16* to these *Provisions*, and where the MCE_R and/or MCE_G ground motions for the default site class have changed by greater than 15%, an explanation of which Project '17 and/or USGS modifications are the predominant causes is provided below. Changes less than 15%, while potentially impactful, tend to be combinations of several of the Project '17 and/or USGS modifications, and hence do not lend themselves to clear explanations. For changes to example locations outside of the conterminous United States, see (FEMA, 2020).

As seen from Table C22-3 and Figure C22-1, which are for the short-period MCE_R spectral response accelerations, the S_{MS} values change from *ASCE/SEI 7-16* to these *Provisions* by less than 15% at all but 3 of the 34 locations, which are explained below. From *ASCE/SEI 7-10* to *ASCE/SEI 7-16*, the S_{MI} values changed by more than 15% at 20 of the 34 locations.

- The increase at the Sacramento location (from 0.76g to 0.97g) is mostly due to the Project '17 modification to site class effects. At this location, the ratio from these *Provisions* of the 0.2-second spectral response acceleration for the default site class divided by that for Site Class BC is approximately 20% greater than the corresponding *ASCE/SEI 7-16* site coefficient.
- The increase at the Vallejo location (from 1.80g to 2.42g) is mostly due to the Project '17 modification to deterministic capping. Whereas *ASCE/SEI 7-16* excluded the nearby Franklin fault from deterministic capping, based on its geologic rate of slip alone, these *Provisions* include it, based on the hazard deaggregations now used for the caps. In addition to geologic slip rates, the hazard deaggregations account for geodetic data (from the Global Positioning System, GPS) that are used by the 2014 and 2018 USGS NSHMs. The deaggregations for the Vallejo location reveal that the Franklin fault is a primary contributor to the hazard.
- The decrease at the New York location (from 0.46g to 0.31g) is mostly due to a combination of the USGS NSHM update and the Project '17 modification to site class effects. At this location, the ratio from these *Provisions* of the 0.2-second spectral response acceleration for the default site class divided by that for Site Class BC is approximately 20% less than the corresponding *ASCE/SEI 7-16* site

coefficient. Even for Site Class BC, the NGA-East ground motion models decrease the 0.2-second spectral response acceleration at this location.

As seen from Table C22-4 and Figure C22-2, which are for the 1.0-second MCE_R spectral response accelerations, the S_{MI} values change from *ASCE/SEI 7-16* to these *Provisions* by more than 15% at 11 of the 34 locations, which are explained below. At 8 of these 11 locations, the S_{MI} values decrease. Note that these decreases are relative to *ASCE/SEI 7-16* values that include the 1.5 multiplier of the applicable Section 11.4.8 exception. With this multiplier, from *ASCE/SEI 7-10* to *ASCE/SEI 7-16* the S_{MS} values changed by more than 15% at all but 3 of the 34 locations.

- The increases at the locations in San Bernardino (from 2.37g to 2.83g) and San Mateo (from 1.88g to 2.30g) are mostly due to the Project '17 modification to the spectral periods considered for S_{MI} . At a period of 1.0 seconds, without the consideration of longer periods, the spectral response accelerations of these *Provisions* (namely 2.39g and 1.84g at the San Bernardino and San Mateo locations, respectively) are within a few percent of those from *ASCE/SEI 7-16*.
- The decreases at the locations in Tacoma (from 1.29g to 0.96g), Everett (from 1.20g to 0.97g), and Portland (from 1.13g to 0.78g) are mostly due to the Project '17 modification to site class effects. At these Pacific Northwest locations (and similarly at the Seattle location), the ratios from these *Provisions* of the 1.0-second spectral response acceleration for the default site class divided by that for Site Class BC are approximately 25% less than the corresponding *ASCE/SEI 7-16* site coefficients. Whereas the latter were based on data and simulations for shallow crustal earthquakes, the former also take into account site class effects for the subduction zone earthquakes of the Pacific Northwest.
- The decrease at the Las Vegas location (from 0.68g to 0.51g) is mostly due to the Project '17 modification to site class effects. Whereas the *ASCE/SEI 7-16* site coefficient in this case is approximately 3.3 (including the 1.5 multiplier of Section 11.4.8), the corresponding ratio from these *Provisions* of the 1.0-second spectral response acceleration for the default site class divided by that for Site Class BC is approximately 2.6. Note that the S_I value of *ASCE/SEI 7-16* is 0.21g, slightly larger than the 0.2g threshold above which the 1.5 multiplier of Section 11.4.8 is applied; if this S_I value were instead slightly less than 0.2g, the *ASCE/SEI 7-16* site coefficients would result in an S_{MS} value within 10% of the corresponding value of these *Provisions*.
- The decreases at the locations in Memphis (from 1.02g to 0.72g) and Charleston (from 1.17g to 0.77g) are again mostly due to the Project '17 modification to site class effects. At these high-hazard CEUS locations, the ratios of the 1.0-second spectral response acceleration for the default site class divided by that for Site Class BC are 30% less than the corresponding *ASCE/SEI 7-16* site coefficients. Whereas the latter were based on western United States data and simulations, the former come from the NGA-East ground motion models for the CEUS.
- The changes at the locations in Sacramento (from 0.79g to 0.63g), Vallejo (from 1.53g to 1.80g), and New York City (from 0.14g to 0.11g) locations are mostly due to the same reasons explained above for S_{MS} , with the following exceptions: Whereas the S_{MS} value increases at the Sacramento location, the S_{MI} value decreases, but still mostly due to the Project '17 modification to site class effects. At the Vallejo location, in addition to the Project '17 modification to deterministic capping, the S_{MI} value also increases as a result of the USGS NSHM update and its incorporation of basin depths.

As seen from Table C22-5 and Figure C22-3, which are for the MCE_G peak ground accelerations, the $PGAM$ values change from *ASCE/SEI 7-16* to these *Provisions* by more than 15% at 7 of the 34 locations, which are explained below. All but one of these changes is a decrease. From *ASCE/SEI 7-10* to *ASCE/SEI 7-16*, the $PGAM$ values changed by more than 15% at 27 of the 34 locations, all but one of which was an increase.

- The decreases at the locations in Oakland (from 0.95g to 0.78g), San Jose (from 0.69g to 0.56g), Santa Cruz (from 0.81g to 0.65g), Santa Rosa (1.22g to 1.04g), and Reno (from 0.74g to 0.59g) are due to combinations of less than 15% decreases caused by the Project '17 modifications to deterministic capping and less than 10% decreases caused by the Project '17 modification to site effects. Both decreases can be related to the relatively large epsilons of peak ground accelerations compared to longer-period spectral response accelerations.
- The changes at the locations in Vallejo (from 0.74g to 0.88g) and New York City (from 0.26g to 0.18g) are due to the same reasons explained above for S_{MS} .

As seen from Table C22-6, four of the SDCs change from SDC D in *ASCE/SEI 7-16* to SDC E in these *Provisions*, as a result of increases in S_I from below 0.75g to at or above it. At the Vallejo location, the increase can be attributed to the Project '17 deterministic capping change (as elaborated upon above) and the incorporation of basin depths in the USGS NSHM. At the Concord location, the increase is mostly due to the modification to deterministic capping. At the Long Beach location, the increase is mostly due to the incorporation of basin depths. At the San Mateo location, the S_I increase is relatively small, approximately 10%, but it can be attributed to a relatively small change in deterministic capping. Note that one of the SDCs assigned using the short-period Table 11.6-1 alone changes from *ASCE/SEI 7-16* to these *Provisions*. At the Boise location, the short-period SDC increases from B to C, due to a 4% increase in the S_{MS} value. By itself, recall that the Project '17 modification to the maximum-response scale factors increases short-period spectral response accelerations by as much as 9%.

In summary, the S_{MS} values change by more than 15% at only 3 of the locations, each due to different reasons. The S_{MI} values change (by more than 15%) at 11 of the locations, 8 of which are decreases, all due to the Project '17 modification to site class effects. Lastly, the $PGAM$ values change (by more than 15%) at 7 of the 34 locations, 5 of which are decreases due to combinations of smaller changes caused by the Project '17 modifications to deterministic capping and site class effect. Only a handful of the SDCs at the 34 example locations change from *ASCE/SEI 7-16* to these *Provisions*, mostly from SDC D to E.

Table C22-2 Latitudes and Longitudes at which MCE_R and MCE_G Ground Motions and corresponding Seismic Design Categories from these *Provisions*, *ASCE/SEI 7-16*, and *ASCE/SEI 7-10* are Compared in Tables C22-3 through C22-6

Region	City and Location of Site			County or Metropolitan Statistical Area	
	Name	Latitude	Longitude	Name	Population
Southern California	Los Angeles	34.05	-118.25	Los Angeles	9,948,081
	Century City	34.05	-118.40		
	Northridge	34.20	-118.55		
	Long Beach	33.80	-118.20		

	Irvine	33.65	-117.80	Orange	3,002,048
	Riverside	33.95	-117.40	Riverside	2,026,603
	San Bernardino	34.10	-117.30	San Bernardino	1,999,332
	San Luis Obispo	35.30	-120.65	San Luis Obispo	257,005
	San Diego	32.70	-117.15	San Diego	2,941,454
	Santa Barbara	34.45	-119.70	Santa Barbara	400,335
	Ventura	34.30	-119.30	Ventura	799,720
	Total Population—S. California		22,349,098	Population—8 Counties	21,374,788
Northern California	Oakland	37.80	-122.25	Alameda	1,502,759
	Concord	37.95	-122.00	Contra Costa	955,810
	Monterey	36.60	-121.90	Monterey	421,333
	Sacramento	38.60	-121.50	Sacramento	1,233,449
	San Francisco	37.75	-122.40	San Francisco	776,733
	San Mateo	37.55	-122.30	San Mateo	741,444
	San Jose	37.35	-121.90	Santa Clara	1,802,328
	Santa Cruz	36.95	-122.05	Santa Cruz	275,359
	Vallejo	38.10	-122.25	Solano	423,473
	Santa Rosa	38.45	-122.70	Sonoma	489,290
	Total Population—N. California		14,108,451	Population—10 Counties	8,621,978

Pacific Northwest	Seattle	47.60	-122.30	King, WA	1,826,732
	Tacoma	47.25	-122.45	Pierce, WA	766,878
	Everett	48.00	-122.20	Snohomish, WA	669,887
	Portland	45.50	-122.65	Portland Metro, OR (3)	1,523,690
	Total Population—OR and WA		10,096,556	Population—6 Counties	4,787,187
Other WUS	Salt Lake City	40.75	-111.90	Salt Lake, UT	978,701
	Boise	43.60	-116.20	Ada/Canyon, ID (2)	532,337
	Reno	39.55	-119.80	Washoe, NV	396,428
	Las Vegas	36.20	-115.15	Clarke, NV	1,777,539
	Total Population—ID/UT/NV		6,512,057	Population—5 Counties	3,685,005
CEUS	St. Louis	38.60	-90.20	St. Louis MSA (16)	2,786,728
	Memphis	35.15	-90.05	Memphis MSA (8)	1,269,108
	Charleston	32.80	-79.95	Charleston MSA (3)	603,178
	Chicago	41.85	-87.65	Chicago MSA (7)	9,505,748
	New York	40.75	-74.00	New York MSA (23)	18,747,320
	Total Population—MO/TN/SC/IL/NY		48,340,918	Population—57 Counties	32,912,082

Note: These 34 locations are the same as those considered in *ASCE/SEI 7-16* and *ASCE/SEI 7-10*, which were first introduced in the *2009 NEHRP Provisions*. It is important to note that these locations are each just one of many in the named cities, and their ground motions may be significantly different than those at other locations in the cities.

Table C22-3 Comparison of short-period MCE_R spectral response acceleration values from these Provisions, ASCE/SEI 7-16, and ASCE/SEI 7-10. The S_{MS} values are for the default site class.

Location Name	ASCE/SEI 7-10		ASCE/SEI 7-16		2020 Provisions	
	S_S (g)	S_{MS} (g)	S_S (g)	S_{MS} (g)	S_S (g)	S_{MS} (g)
Los Angeles, CA	2.40	2.40	1.97	2.36	2.25	2.37
Century City, CA	2.17	2.17	2.11	2.53	2.37	2.49
Northridge, CA	1.69	1.69	1.74	2.08	2.09	2.26
Long Beach, CA	1.64	1.64	1.68	2.02	1.90	2.03
Irvine, CA	1.55	1.55	1.25	1.50	1.43	1.68
Riverside, CA	1.50	1.50	1.50	1.80	1.50	1.67
San Bernardino, CA	2.37	2.37	2.33	2.79	2.78	2.97
San Luis Obispo, CA	1.12	1.18	1.09	1.31	1.23	1.45
San Diego, CA	1.25	1.25	1.58	1.89	1.74	1.80
Santa Barbara, CA	2.83	2.83	2.12	2.54	2.37	2.44
Ventura, CA	2.38	2.38	2.02	2.42	2.25	2.38
Oakland, CA	1.86	1.86	1.88	2.26	2.07	2.21
Concord, CA	2.08	2.08	2.22	2.67	2.77	2.85
Monterey, CA	1.53	1.53	1.33	1.59	1.50	1.75
Sacramento, CA	0.67	0.85	0.57	0.76	0.66	0.97
San Francisco, CA	1.50	1.50	1.50	1.80	1.57	1.81
San Mateo, CA	1.85	1.85	1.80	2.16	2.10	2.30
San Jose, CA	1.50	1.50	1.50	1.80	1.50	1.65
Santa Cruz, CA	1.52	1.52	1.59	1.91	1.65	1.86
Vallejo, CA	1.50	1.50	1.50	1.80	2.33	2.42
Santa Rosa, CA	2.51	2.51	2.41	2.90	2.81	2.93
Seattle, WA	1.37	1.37	1.40	1.68	1.56	1.76
Tacoma, WA	1.30	1.30	1.36	1.63	1.50	1.62
Everett, WA	1.27	1.27	1.20	1.44	1.36	1.55
Portland, OR	0.98	1.09	0.89	1.07	0.94	1.15
Salt Lake City, UT	1.54	1.54	1.55	1.85	1.76	1.81
Boise, ID	0.31	0.48	0.31	0.48	0.33	0.50
Reno, NV	1.50	1.50	1.47	1.76	1.54	1.74
Las Vegas, NV	0.50	0.70	0.65	0.83	0.70	0.82
St Louis, MO	0.44	0.64	0.46	0.66	0.63	0.68
Memphis, TN	1.01	1.11	1.03	1.23	1.32	1.25
Charleston, SC	1.15	1.20	1.42	1.70	1.66	1.52
Chicago, IL	0.14	0.22	0.12	0.19	0.15	0.20
New York City, NY	0.28	0.44	0.29	0.46	0.28	0.31

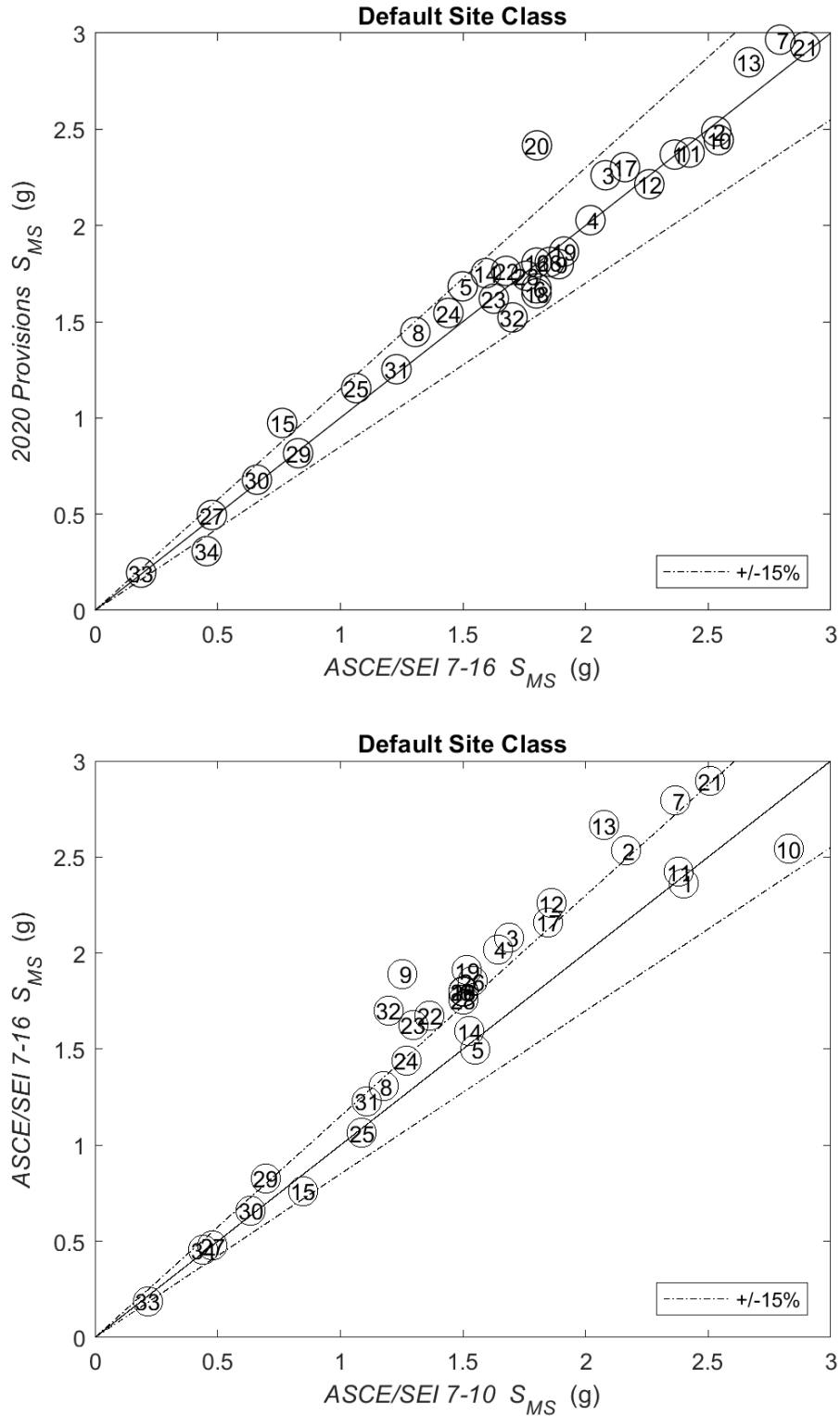

Figure C22-1 Comparison of short-period MCE_R spectral response acceleration (S_{MS}) values from these Provisions vs. ASCE/SEI 7-16 (upper panel) and ASCE/SEI 7-16 vs. ASCE/SEI 7-10 (lower panel), for the default site class and 34 example locations.

Table C22-4 Comparison of 1.0-second MCE_R spectral response acceleration values from these Provisions, ASCE/SEI 7-16, and ASCE/SEI 7-10. The S_{MI} values are for the default site class. The ASCE/SEI 7-16 S_{MI} values include the 1.5 multiplier of the applicable Section 11.4.8 exception.

Location Name	ASCE/SEI 7-10		ASCE/SEI 7-16		2020 Provisions	
	S_I (g)	S_{MI} (g)	S_I (g)	S_{MI} (g)	S_I (g)	S_{MI} (g)
Los Angeles, CA	0.84	1.26	0.70	1.79	0.72	1.66
Century City, CA	0.80	1.21	0.75	1.92	0.92	1.84
Northridge, CA	0.60	0.90	0.60	1.53	0.70	1.65
Long Beach, CA	0.62	0.93	0.61	1.55	0.75	1.58
Irvine, CA	0.57	0.86	0.45	1.24	0.45	1.12
Riverside, CA	0.60	0.90	0.58	1.50	0.58	1.45
San Bernardino, CA	1.08	1.63	0.93	2.37	1.07	2.83
San Luis Obispo, CA	0.43	0.67	0.40	1.14	0.40	1.00
San Diego, CA	0.48	0.73	0.53	1.40	0.53	1.23
Santa Barbara, CA	0.99	1.49	0.78	1.98	0.87	1.89
Ventura, CA	0.90	1.35	0.76	1.95	1.01	2.10
Oakland, CA	0.75	1.12	0.72	1.83	0.72	1.70
Concord, CA	0.74	1.10	0.67	1.72	0.87	1.90
Monterey, CA	0.56	0.84	0.50	1.34	0.49	1.21
Sacramento, CA	0.29	0.53	0.25	0.79	0.24	0.63
San Francisco, CA	0.64	0.96	0.60	1.53	0.60	1.75
San Mateo, CA	0.86	1.29	0.74	1.88	0.81	2.30
San Jose, CA	0.60	0.90	0.60	1.53	0.61	1.70
Santa Cruz, CA	0.60	0.90	0.60	1.54	0.59	1.47
Vallejo, CA	0.60	0.90	0.60	1.53	0.89	1.80
Santa Rosa, CA	1.04	1.55	0.94	2.39	1.15	2.40
Seattle, WA	0.53	0.79	0.49	1.32	0.66	1.38
Tacoma, WA	0.51	0.76	0.47	1.29	0.46	0.96
Everett, WA	0.48	0.73	0.43	1.20	0.47	0.97
Portland, OR	0.42	0.66	0.39	1.13	0.36	0.78
Salt Lake City, UT	0.56	0.84	0.56	1.45	0.62	1.28
Boise, ID	0.11	0.25	0.11	0.26	0.10	0.28
Reno, NV	0.52	0.78	0.52	1.38	0.54	1.32
Las Vegas, NV	0.17	0.36	0.21	0.68	0.20	0.51
St Louis, MO	0.17	0.36	0.16	0.39	0.18	0.38
Memphis, TN	0.35	0.60	0.35	1.02	0.35	0.72
Charleston, SC	0.37	0.61	0.41	1.17	0.38	0.77
Chicago, IL	0.062	0.15	0.063	0.15	0.070	0.15
New York City, NY	0.072	0.17	0.060	0.14	0.051	0.11

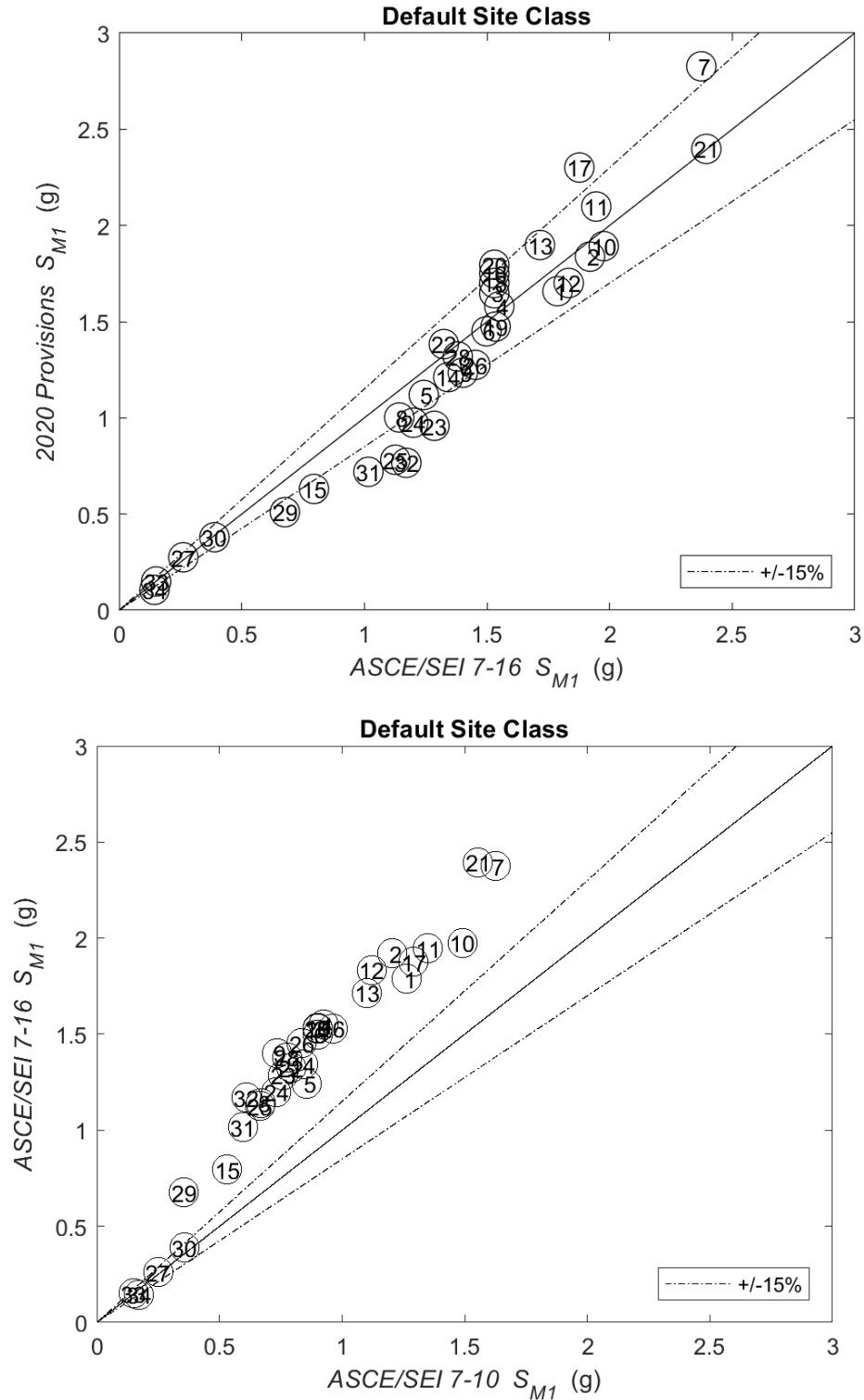

Figure C22-2 Comparison of 1.0-second MCE_R spectral response acceleration (S_{M1}) values from these Provisions vs. ASCE/SEI 7-16 (upper panel) and ASCE/SEI 7-16 vs. ASCE/SEI 7-10 (lower panel), for the default site class and 34 example locations. The ASCE/SEI 7-16 values include the 1.5 multiplier of the applicable Section 11.4.8 exception.

Table C22-5 Comparison of MCE_G peak ground acceleration values from these Provisions, ASCE/SEI 7-16, and ASCE/SEI 7-10. The PGA_M values are for the default site class. The 2020 Provisions have replaced the notation PGA of ASCE/SEI 7-10 and ASCE/SEI 7-16 with “ PGA_M for Site Class BC,” abbreviated here as “ PGA .”

Location Name	ASCE/SEI 7-10		ASCE/SEI 7-16		2020 Provisions	
	PGA (g)	PGA_M (g)	PGA (g)	PGA_M (g)	" PGA " (g)	PGA_M (g)
Los Angeles, CA	0.91	0.91	0.84	1.01	0.85	0.94
Century City, CA	0.81	0.81	0.91	1.09	0.91	0.99
Northridge, CA	0.62	0.62	0.71	0.86	0.72	0.80
Long Beach, CA	0.64	0.64	0.74	0.89	0.74	0.82
Irvine, CA	0.60	0.60	0.53	0.63	0.54	0.64
Riverside, CA	0.50	0.50	0.50	0.60	0.50	0.58
San Bernardino, CA	0.91	0.91	0.98	1.18	0.95	1.04
San Luis Obispo, CA	0.44	0.47	0.48	0.58	0.49	0.58
San Diego, CA	0.57	0.57	0.72	0.86	0.71	0.78
Santa Barbara, CA	1.09	1.09	0.93	1.12	0.93	1.01
Ventura, CA	0.91	0.91	0.89	1.06	0.87	0.95
Oakland, CA	0.72	0.72	0.79	0.95	0.72	0.78
Concord, CA	0.79	0.79	0.90	1.07	0.96	1.01
Monterey, CA	0.59	0.59	0.58	0.69	0.58	0.68
Sacramento, CA	0.23	0.31	0.24	0.32	0.25	0.34
San Francisco, CA	0.57	0.57	0.58	0.70	0.54	0.63
San Mateo, CA	0.73	0.73	0.78	0.93	0.72	0.81
San Jose, CA	0.50	0.50	0.58	0.69	0.50	0.56
Santa Cruz, CA	0.59	0.59	0.67	0.81	0.58	0.65
Vallejo, CA	0.51	0.51	0.62	0.74	0.81	0.88
Santa Rosa, CA	0.97	0.97	1.02	1.22	0.95	1.04
Seattle, WA	0.56	0.56	0.60	0.72	0.61	0.73
Tacoma, WA	0.50	0.50	0.50	0.60	0.50	0.58
Everett, WA	0.52	0.52	0.51	0.62	0.54	0.64
Portland, OR	0.43	0.46	0.40	0.48	0.40	0.50
Salt Lake City, UT	0.67	0.67	0.70	0.84	0.72	0.77
Boise, ID	0.12	0.19	0.14	0.21	0.13	0.19
Reno, NV	0.50	0.50	0.62	0.74	0.54	0.59
Las Vegas, NV	0.20	0.28	0.28	0.37	0.27	0.34
St Louis, MO	0.23	0.31	0.27	0.36	0.33	0.33
Memphis, TN	0.50	0.50	0.61	0.73	0.74	0.70
Charleston, SC	0.75	0.75	0.93	1.12	1.07	0.97
Chicago, IL	0.068	0.11	0.059	0.094	0.072	0.081
New York City, NY	0.17	0.25	0.18	0.26	0.17	0.18

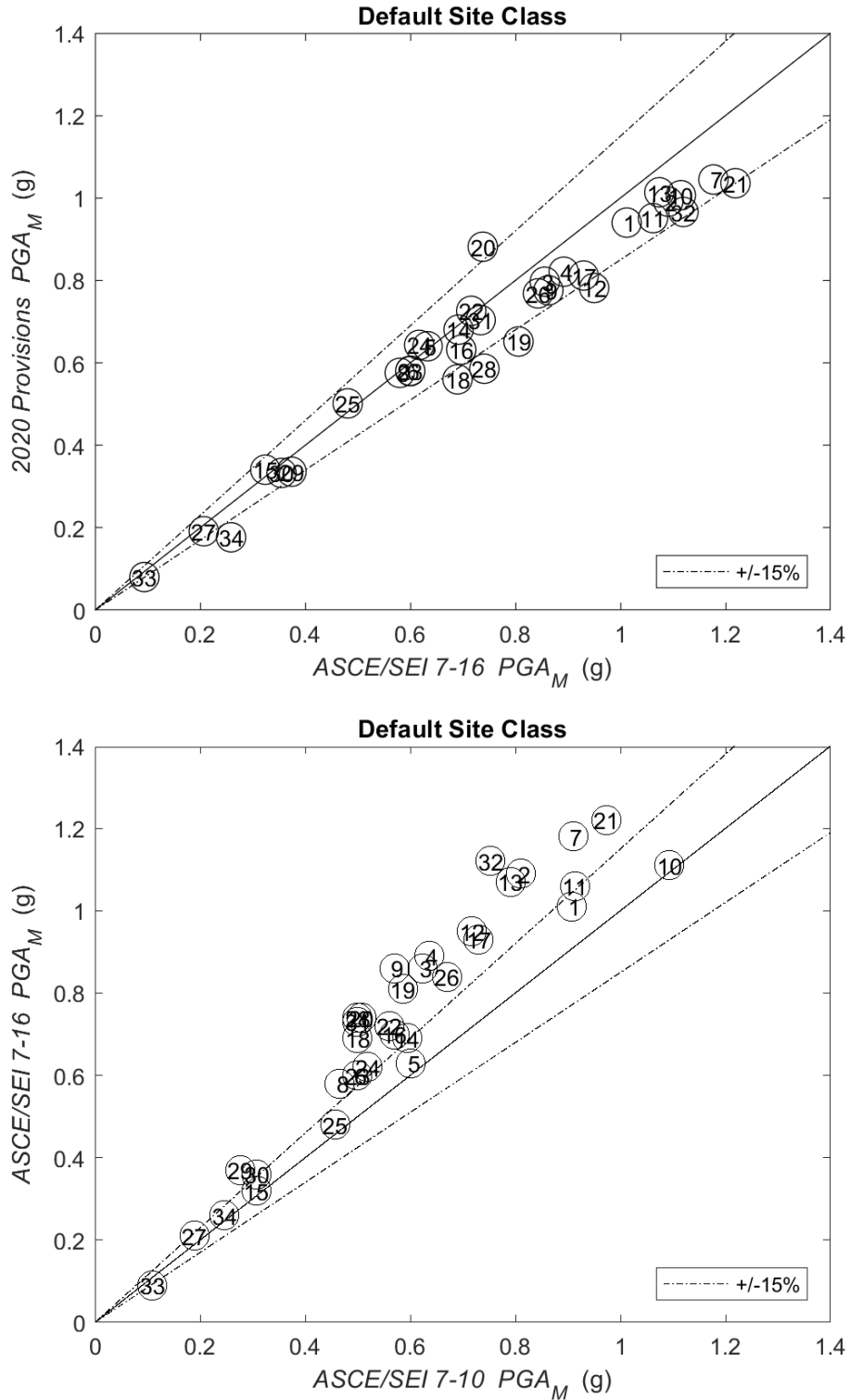

Figure C22-3 Comparison of MCE_G peak ground acceleration (PGA_M) values from these Provisions vs. ASCE/SEI 7-16 (upper panel) and ASCE/SEI 7-16 vs. ASCE/SEI 7-10 (lower panel), for the default site class and 34 example locations.

Table C22-6 Comparison of seismic design categories from these *Provisions*, *ASCE/SEI 7-16*, and *ASCE/SEI 7-10*, for the default site class and risk categories I, II, or III. The “SDC_s” categories are determined from Table 11.6-1 (“Seismic Design Category Based on Short-Period Response Acceleration Parameter”) alone, but only where $S_I < 0.75g$.

Location Name	<i>ASCE/SEI 7-10</i>		<i>ASCE/SEI 7-16</i>		<i>2020 Provisions</i>	
	"SDC _s "	SDC	"SDC _s "	SDC	"SDC _s "	SDC
Los Angeles, CA	N/A	E	D	D	D	D
Century City, CA	N/A	E	N/A	E	N/A	E
Northridge, CA	D	D	D	D	D	D
Long Beach, CA	D	D	D	D	N/A	E
Irvine, CA	D	D	D	D	D	D
Riverside, CA	D	D	D	D	D	D
San Bernardino, CA	N/A	E	N/A	E	N/A	E
San Luis Obispo, CA	D	D	D	D	D	D
San Diego, CA	D	D	D	D	D	D
Santa Barbara, CA	N/A	E	N/A	E	N/A	E
Ventura, CA	N/A	E	N/A	E	N/A	E
Oakland, CA	D	D	D	D	D	D
Concord, CA	D	D	D	D	N/A	E
Monterey, CA	D	D	D	D	D	D
Sacramento, CA	D	D	D	D	D	D
San Francisco, CA	D	D	D	D	D	D
San Mateo, CA	N/A	E	D	D	N/A	E
San Jose, CA	D	D	D	D	D	D
Santa Cruz, CA	D	D	D	D	D	D
Vallejo, CA	D	D	D	D	N/A	E
Santa Rosa, CA	N/A	E	N/A	E	N/A	E
Seattle, WA	D	D	D	D	D	D
Tacoma, WA	D	D	D	D	D	D
Everett, WA	D	D	D	D	D	D
Portland, OR	D	D	D	D	D	D
Salt Lake City, UT	D	D	D	D	D	D
Boise, ID	B	C	B	C	C	C
Reno, NV	D	D	D	D	D	D
Las Vegas, NV	C	D	D	D	D	D
St Louis, MO	C	D	C	D	C	D
Memphis, TN	D	D	D	D	D	D
Charleston, SC	D	D	D	D	D	D
Chicago, IL	A	B	A	B	A	B
New York City, NY	B	B	B	B	B	B

RISK-TARGETED MAXIMUM CONSIDERED EARTHQUAKE (MCE_R) SPECTRAL RESPONSE ACCELERATIONS

Using the most recent USGS National Seismic Hazard Models (NSHMs) for the conterminous United States and the other U.S. states and territories, MCE_R spectral response accelerations of these *Provisions* have been prepared in accordance with the site-specific procedures of Sections 21.2 through 21.4, with approximations outside of the conterminous United States that are explained in the ensuing paragraphs. To prepare the MCE_R maps in this chapter, which are for the default site class, the site-specific procedures are followed for Site Classes C, CD, and D. In accordance with Section 11.4.2.1, the resulting multi-period response spectra are enveloped. It is from the envelope spectrum that S_{MS} for the default site class is computed in accordance with Section 21.4. To derive values of the parameters S_S and S_I , the site-specific procedures are followed for spectral periods of 0.2 and 1.0 seconds and Site Class BC. As specified in Section 21.2.3, the MCE_R spectral response acceleration for each site class and period represents the lesser of a probabilistic ground motion defined in Section 21.2.1 and a deterministic ground motion defined in Section 21.2.2. The preparation of the probabilistic and deterministic ground motions is described below.

For the conterminous United States, the probabilistic ground motions for each spectral response period (see Section 11.4.5.1) and site class (A through E) have been calculated using corresponding USGS hazard curves for a grid of locations. The USGS hazard curves are first converted from geometric-mean ground motions (output by the ground motion models available to the USGS) to ground motions in the direction of maximum horizontal spectral response acceleration—the conversions were done by applying the factors specified in the site-specific procedures commentary (Section C21.2), e.g., 1.2 at 0.2 s and 1.25 at 1.0 s. See the commentary to Section 21.2.1 and Luco et al. (2007) for information on the development of risk-targeted probabilistic ground motions from hazard curves.

For the states and territories outside of the conterminous United States, the probabilistic ground motions for spectral response periods of 0.2 and 1.0 seconds and the BC site class have been calculated as described in the preceding paragraph, with one exception. The USGS hazard curves for Hawaii, without conversion, are deemed to represent the maximum-response ground motions because of the ground motion models applied there. The probabilistic ground motions for the other spectral response periods and site classes are estimated from T_L and the probabilistic ground motions for spectral response periods of 0.2 and 1.0 seconds and the BC site class by means of a procedure documented in (FEMA, 2020). This approximation is temporary, awaiting future USGS updates for the states and territories outside of the conterminous United States.

The deterministic ground motions for the conterminous United States, for each spectral response period and site class, have been calculated via USGS hazard deaggregations for the corresponding probabilistic ground motions. As explained in the commentary of Section 21.2.2, the hazard deaggregation at each site (and period and site class) provides a mean earthquake magnitude for each fault in the region, which is termed a scenario earthquake. The requisite 84th-percentile spectral response acceleration for each scenario earthquake can be calculated using the same ground motion models used for the probabilistic spectral response acceleration and the deaggregation. Alternatively, the mean epsilon for each scenario that is output from the deaggregation can be used to estimate the 84th-percentile ground motion. The epsilon corresponds to the percentile of the probabilistic ground motion, per the normal cumulative distribution function used in ground motion models. For example, epsilons of 0, 1, and 2 correspond to the 50th, 84th, and 98th percentiles, respectively. With a logarithmic standard deviation of ground motion for a given scenario earthquake, σ , the 84th-percentile ground motion can be calculated from the probabilistic ground motion and its epsilon, ε . This is done by dividing the probabilistic ground motion by $\exp(\varepsilon \cdot \sigma) \div \exp(1 \cdot \sigma)$. As the MCE_R (and MCE_G) maps of *ASCE/SEI 7-16* (and back to the *2009 NEHRP Provisions*) used a σ value of 0.6 to estimate 84th-percentile ground motions from medians (50th percentiles), via a multiplier of $\exp(0.6)=1.8$, the same σ of 0.6 is used for the maps of these *Provisions*. Examples of the calculation of

84th-percentile ground motions are given in Table C22-7. Starting with the same grid of locations considered for the probabilistic ground motions, such calculations have been done for all of the locations and site classes where the probabilistic ground motions exceed, at one or more spectral response periods, the deterministic lower limits of Table 21.2-1. For more information on the development of the deterministic ground motions for the MCE_R maps of these *Provisions*, see the commentary of Section 21.2.2 and Luco et al., 2020.

Table C22-7 Examples of 84th-percentile ground motions (abbreviated 84th GM) calculated using epsilons from hazard deaggregations (ε) and the corresponding probabilistic ground motions, at a site class BC location in San Jose, California

Period T (s)	Prob. GM (g)	Scenario Earthquakes					
		Hayward		Calaveras		San Andreas	
		ε	84th GM (g)	ε	84th GM (g)	ε	84th GM (g)
0.20	2.36	1.87	1.40	1.88	1.39	2.07	1.24
0.25	2.19	1.84	1.32	1.84	1.32	1.99	1.21
0.30	2.03	1.83	1.23	1.81	1.25	1.95	1.15
0.40	1.73	1.81	1.06	1.80	1.07	1.91	1.00
0.50	1.53	1.80	0.95	1.78	0.96	1.85	0.92
0.75	1.15	1.77	0.72	1.75	0.73	1.76	0.73
1.0	0.92	1.77	0.58	1.75	0.59	1.74	0.59
1.5	0.62	1.72	0.40	1.73	0.40	1.67	0.41
2.0	0.47	1.69	0.31	1.71	0.31	1.60	0.33
3.0	0.32	1.60	0.22	1.63	0.22	1.39	0.25
4.0	0.25	1.49	0.19	1.50	0.19	1.15	0.23
5.0	0.20	1.36	0.16	1.41	0.16	0.97	0.20

The deterministic ground motions outside of the conterminous United States have been calculated in accordance with the site-specific procedures of *ASCE/SEI 7-16*, for spectral response periods of 0.2 and 1.0 seconds and the BC site class (denoted here as $S_{0.2D}$ and $S_{1.0D}$). More specifically, they have been calculated from “characteristic earthquake on all known active faults.” The largest characteristic magnitude considered by the USGS on each fault, excluding any lower weighted magnitudes from the USGS logic tree for epistemic uncertainty, is used for the deterministic ground motions. For each characteristic earthquake, the USGS has computed median (50th percentile), geometric-mean ground motions. To convert to maximum-response ground motions, the same scale factors mentioned above for probabilistic ground motions are applied. To approximately convert to 84th-percentile ground motions, the maximum-response ground

motions are multiplied by 1.8. The probabilistic ground motions for the other spectral response periods and site classes are estimated from $S_{0.2D}$ and $S_{1.0D}$ using (FEMA, 2020).

MAXIMUM CONSIDERED EARTHQUAKE GEOMETRIC MEAN (MCE_G) PEAK GROUND ACCELERATIONS

Using the most recent USGS National Seismic Hazard Models (NSHMs) for the conterminous United States and the other U.S. states and territories, the MCE_G peak ground accelerations (i.e., the PGA_M values for each site class) of these *Provisions* have been prepared in accordance with the site-specific procedures of Section 21.5, with two approximations outside of the conterminous United States. There, the underlying probabilistic and deterministic peak ground accelerations are estimated from those for site class BC using (FEMA, 2020). Even for site class BC, the deterministic ground motions are not yet calculated from scenario earthquakes from hazard deaggregations, but rather from the characteristic earthquakes called for in previous editions of the *ASCE/SEI 7 Standard*. These two approximations outside of the conterminous United States are temporary, awaiting future USGS updates. For the conterminous United States, the PGA_M values are in full accordance with the site-specific procedures. Since the MCE_G maps (like the MCE_R maps) are for the default site class, the site-specific procedures (or approximations outside of the conterminous United States) have been followed for Site Classes C, CD, and D, and the largest of the three PGA_M values was mapped.

LONG-PERIOD TRANSITION MAPS

The maps of the long-period transition period, T_L (Figs. 22-14 through 22-17), were introduced in ASCE/SEI 7-05. They were prepared by the USGS in response to Building Seismic Safety Council recommendations and were subsequently included in the NEHRP Provisions (2003). See Section C11.4.6 for a discussion of the technical basis of these maps. The value of T_L obtained from these maps is used in Eq. (11.4-7) to determine values of S_a for periods greater than T_L .

The exception in Section 15.7.6.1, regarding the calculation of S_{ac} , the convective response spectral acceleration for tank response, is intended to provide the user the option of computing this acceleration with three different types of site-specific procedures: (a) the procedures in Chapter 21, provided that they cover the natural period band containing T_c , the fundamental convective period of the tank-fluid system; (b) ground motion simulation methods using seismological models; and (c) analysis of representative accelerogram data. Elaboration of these procedures is provided below.

With regard to the first procedure, attenuation equations have been developed for the western United States (Next Generation Attenuation, e.g., Power et al. 2008) and for the central and eastern United States (e.g., Somerville et al. 2001) that cover the period band, 0 to 10 s. Thus, for $T_c \leq 10$ s, the fundamental convective period range for nearly all storage tanks, these attenuation equations can be used in the same probabilistic seismic hazard analysis (PSHA) and deterministic seismic hazard analysis (DSHA) procedures described in Chapter 21 to compute $S_a(T_c)$. The 1.5 factor in Eq. (15.7-11), which converts a 5% damped spectral acceleration to a 0.5% damped value, could then be applied to obtain S_{ac} . Alternatively, this factor could be established by statistical analysis of 0.5% damped and 5% damped response spectra of accelerograms representative of the ground motion expected at the site.

In some regions of the United States, such as the Pacific Northwest and southern Alaska, where subduction-zone earthquakes dominate the ground motion hazard, attenuation equations for these events only extend to periods between 3 and 5 s, depending on the equation. Thus, for tanks with T_c greater than these periods, other site-specific methods are required.

The second site-specific method to obtain S_a at long periods is simulation through the use of seismological models of fault rupture and wave propagation (e.g., Graves and Pitarka 2004, Hartzell and Heaton 1983, Hartzell et al. 1999, Liu et al. 2006, and Zeng et al. 1994). These models could range from simple seismic source-theory and wave-propagation models, which currently form the basis for many of the attenuation equations used in the central and eastern United States, for example, to more complex numerical models that incorporate finite fault rupture for scenario earthquakes and seismic wave propagation through 2D or 3D models of the regional geology, which may include basins. These models are particularly attractive for computing long-period ground motions from great earthquakes ($M_w \geq 8$) because ground motion data are limited for these events. Furthermore, the models are more accurate for predicting longer period ground motions because (a) seismographic recordings may be used to calibrate these models and (b) the general nature of the 2D or 3D regional geology is typically fairly well resolved at these periods and can be much simpler than would be required for accurate prediction of shorter period motions.

A third site-specific method is the analysis of the response spectra of representative accelerograms that have accurately recorded long-period motions to periods greater than T_c . As T_c increases, the number of qualified records decreases. However, as digital accelerographs continue to replace analog accelerographs, more recordings with accurate long-period motions are becoming available. Nevertheless, a number of analog and digital recordings of large and great earthquakes are available that have accurate long-period motions to 8 s and beyond. Subsets of these records, representative of the earthquake(s) controlling the ground motion hazard at a site, can be selected. The 0.5% damped response spectra of the records can be scaled using seismic source theory to adjust them to the magnitude and distance of the controlling earthquake. The levels of the scaled response spectra at periods around T_c can be used to determine S_{ac} . If the subset of representative records is limited, then this method should be used in conjunction with the aforementioned simulation methods.

USGS SEISMIC DESIGN GEODATABASE AND WEB SERVICE

As maps of MCE_R and MCE_G ground motions for all of the site classes (and all of the MCE_R spectral periods) are too numerous to include in these *Provisions*, gridded values of the ground motions are contained in the online USGS Seismic Design Geodatabase archive defined in Section 11.2. To spatially interpolate between these gridded ground motions for a user-specified latitude and longitude (and site class), the USGS has developed a web service. The web service returns S_s , S_l , S_{MS} , S_{MI} , $PGAM$, and T_L values, as well as MCE_R multi-period response spectra. For visualization, the USGS has also prepared online maps for all of the site classes. As summarized above, all of these online resources have been developed following the site-specific procedures of Chapter 21. They are accessible via <https://doi.org/10.5066/F7NK3C76>.

REFERENCES

- Aagaard, B. T., Brocher, T. M., Dolenc, D., Dreger, D., Graves, R. W., Harmsen, S., Hartzell, S., Larsen, S., McCandless, K., Nilsson, S., Petersson, N. A., Rodgers, A., Sjögreen B., and Zoback, M. L. (2008). “Ground-motion modeling of the 1906 San Francisco earthquake, part II: Ground motion estimates for the 1906 earthquake and scenario events,” *Bulletin of the Seismological Society of America*, 98, 1012–1046.
- Al Atik, L. (2015). “NGA-East: ground-motion standard deviation models for Central and Eastern North America,” *PEER Report No. 2015/07*, Pacific Earthquake Engineering Research Center
- Atkinson, G. M., and Boore, D. M. (2003). “Empirical ground-motion relations for subduction-zone earthquakes and their application to Cascadia and other regions,” *Bulletin of the Seismological Society of America*, 93(4), 1703-1729.
- Atkinson, G. M., and Boore, D. M. (2008). “Erratum to empirical ground-motion relations for

- subduction zone earthquakes and their application to Cascadia and other regions,” *Bulletin of the Seismological Society of America*, 98(5) 2567-2569.
- BSSC. (2019). *BSSC Project 17 Final Report: Development of next generation of seismic design value maps for the 2020 NEHRP Provisions*, Building Seismic Safety Council, National Institute of Building Sciences, Washington, DC.
- FEMA. (2020). “Procedures for developing multi-period response spectra at non-conterminous United States sites.” *FEMA P-2078*, Washington, D.C.
- Goulet, C.A. et al. (2017). “NGA-East ground-motion models for the U.S. Geological Survey national seismic hazard maps,” *PEER Report No. 2017/03*, Pacific Earthquake Engineering Research Center
- Graves, R. W., and Pitarka, A. (2004). “Broadband time history simulation using a hybrid approach.” *Paper 1098*, Proc., 13th World Conference on Earthquake Engineering, Vancouver.
- Hartzell, S., and Heaton, T. (1983). “Inversion of strong ground motion and teleseismic waveform data for the fault rupture history of the 1979 Imperial Valley, California, earthquake.” *Bull. Seismol. Soc. of Am.*, 73, 1553–1583.
- Hartzell, S., Harmsen, S., Frankel, A., and Larsen, S. (1999). “Calculation of broadband time histories of ground motion: Comparison of methods and validation using strong ground motion from the 1994 Northridge earthquake.” *Bull. Seismol. Soc. of Am.*, 89, 1484–1504.
- Idriss, I. M. (2014). “An NGA-West2 empirical model for estimating the horizontal spectral values generated by shallow crustal earthquakes,” *Earthquake Spectra*, 30(3), 1155-1177.
- Kircher & Associates. (2015). *Investigation of an identified shortcoming in the seismic design procedures of ASCE 7-10 and development of recommended improvements for ASCE 7-16*. Prepared for the Building Seismic Safety Council, National Institute of Building Sciences, Washington, D.C., Palo Alto, CA.
- Lee, E. -J., Chen, P., Jordan, T. H., Maechling, P 1057 . J., Denolle, M., and Beroza, G. C. (2014). “Full-3-D tomography for crustal structure in southern California based on the scattering-integral and the adjoint-wavefield methods,” *Journal of Geophysical Research*, 119, 6421–6451.
- Liu, P., Archuleta, R. J., and Hartzell, S. H. (2006). “Prediction of broadband ground-motion time histories: Hybrid low/high-frequency method with correlated random source parameters.” *Bull. Seismol. Soc. of Am.*, 96, 2118–2130.
- Luco, N., Ellingwood, B. R., Hamburger, R. O., Hooper, J. D., Kimball, J. K., and Kircher, C. A. (2007). *Risk-targeted vs. current seismic design maps for the conterminous United States*. Proc., Structural Engineers Association of California 76th Annual Convention . SEAOC, Sacramento, CA.
- Luco, N. et al. (2020). *Using probabilistic hazard disaggregation for the deterministic ground motion capping in U.S. building codes*, Earthquake Spectra, in preparation.
- Magistrale, H., Olsen, K. B., and Pechmann, J. C. (2008). “Construction and verification of a Wasatch Front Community Velocity Model,” *U.S. Geological Survey Technical Report 06HQGR0012*.
- NEHRP. (2003). “Recommended provisions for seismic regulations for new buildings and other structures,” *FEMA 450* . Building Seismic Safety Council, National Institute of Building Sciences, Washington, DC.
- NEHRP. (2009). “Recommended provisions for seismic regulations for new buildings and other structures,” *FEMA 750*. Building Seismic Safety Council, National Institute of Building Sciences, Washington, DC.

- NEHRP. (2015). “Recommended provisions for seismic regulations for new buildings and other structures,” *FEMA 1050*. Building Seismic Safety Council, National Institute of Building Sciences, Washington, DC.
- PEER. (2015). “NGA-East: adjustments to median ground-motion models for central and eastern north america,” *PEER Report No. 2015/08*, Pacific Earthquake Engineering Research Center
- Petersen, M.D. (2014). “Documentation for the 2014 update of the United States national seismic hazard maps,” *USGS Open File Report 2014-1091*. USGS, Reston, VA.
- Petersen, M.D. et al. (2020). “2018 update of the u.s. national seismic hazard model: overview of model, changes, and implications,” *Earthquake Spectra*, *36(1)*: 5-41.
- Power, M., Chiou, B., Abrahamson, N., Bozorgnia, Y., Shantz, T., and Roblee, C. (2008). *An overview of the NGA project*. Earthquake Spectra Special Issue on the Next Generation of Ground Motion Attenuation (NGA) Project. Earthquake Engineering Research Institute, Oakland, CA.
- Rezaeian, S., Powers, P.M., Shumway, A.M., Petersen, M.D., Luco, N., Frankel, A.D., Moschetti, M.P., Thompson, E.M., and McNamara, D.E. *The 2018 Update of the U.S. National Seismic Hazard Model: Ground Motion Models in the Central and Eastern U.S.* Earthquake Spectra, under review.
- Seyhan, E., and Stewart, J. P. (2014). “Semi-empirical nonlinear site amplification from NGAWest2 data and simulations,” *Earthquake Spectra*, *30*, 1241–1256.
- Somerville, P. G., Collins, N., Abrahamson, N., Graves, R., and Saikia, C. (2001). “Earthquake source scaling and ground motion attenuation relations for the Central and Eastern United States.” *Final Report to the USGS under Contract 99HQGR0098*. USGS, Reston, VA.
- Stephenson, W. J. (2007). “Velocity and density models incorporating the Cascadia subduction zone for 3D earthquake ground motion simulations,” *U.S. Geological Survey Open-File Report 2007-1348*, 24 pp.
- Stewart, J.P. et al. (2017). “Expert panel recommendations for ergodic site amplification in central and eastern north america,” *PEER Report No. 2017/04*, Pacific Earthquake Engineering Research Center
- Zeng, Y., Anderson, J. G., and Yu, G. (1994). “A composite source model for computing synthetic strong ground motions.” *Geophys. Res. Lett.*, *21*, 725–728.

Page intentionally left blank.

2020 NEHRP RECOMMENDED SEISMIC PROVISIONS FOR NEW BUILDINGS AND OTHER STRUCTURES

APPENDIX PROJECT PARTICIPANTS

BSSC Provisions Update Committee

Chair	David Bonneville	Degenkolb Engineers
Voting Member	Peter Carrato	Bechtel Power Corporation
Voting Member	Kelly Cobeen	Wiss, Janney, Elstner Associates
Voting Member	C.B. Crouse	AECOM
Voting Member	Dan Dolan	Washington State University
Voting Member	Anindya Dutta	Simpson Gumpertz & Heger
Voting Member	S.K. Ghosh	S.K. Ghosh Associates
Voting Member	John Gillengerten	SE, Retired OSHPD
Voting Member	Ron Hamburger	Simpson Gumpertz & Heger
Voting Member	Jim Harris	James Harris & Associates
Voting Member	William Holmes	Rutherford + Chekene
Voting Member	John Hooper	Magnusson Klemencic Associates
Voting Member	Gyimah Kasali	Rutherford + Chekene
Voting Member	Charles Kircher	Charles Kircher & Associates
Voting Member	Philip Line	American Wood Council
Voting Member	Bret Lizundia	Rutherford + Chekene
Voting Member	James Malley	Degenkolb Engineers
Voting Member	Bonnie Manley	American Iron and Steel Institute
Voting Member	Robert Pekelnicky	Degenkolb Engineers
Voting Member	Rafael Sabelli	Walter P. Moore
Voting Member	John Silva	Hilti
Voting Member	J. G. (Greg) Soules	CB&I Storage Tank Solutions
Voting Member	Jonathan Stewart	University of California, Los Angeles
FEMA technical advisor and representative	Robert Hanson	University of Michigan (Professor Emeritus)
FEMA representative	Mai Tong	Federal Emergency Management Agency
USGS representative	Nicolas Luco	U.S. Geological Survey
USGS representative	Sanaz Rezaeian	U.S. Geological Survey
NIST representative	Steven McCabe	National Institute of Standards and Technology
NIST representative	Matthew Speicher	National Institute of Standards and Technology
NIBS Staff	Jiqiu (JQ) Yuan	National Institute of Building Sciences

BSSC Project 17 Committee on Seismic Design Value Maps

Chair	Ron Hamburger	Simpson Gumpertz & Heger
Voting Member	Norm Abrahamson	University of California Berkeley
Voting Member	David Bonneville	Degenkolb Engineers
Voting Member	C.B. Crouse	AECOM
Voting Member	Dan Dolan	Washington State University
Voting Member	Julie Furr	Rimkus Consulting Group
Voting Member	Jim Harris	James Harris & Associates
Voting Member	Jon Heintz	Applied Technology Council
Voting Member	William Holmes	Rutherford + Chekene
Voting Member	John Hooper	Magnusson Klemencic Associates
Voting Member	Charles Kircher	Charles Kircher & Associates
Voting Member	Robert Pekelnicky	Degenkolb Engineers
Voting Member	Jon Siu	City of Seattle, Washington
Voting Member	Jonathan Stewart	University of California, Los Angeles
USGS representative	Nicolas Luco	U.S. Geological Survey
USGS representative	Sanaz Rezaeian	U.S. Geological Survey
FEMA technical advisor and representative	Robert Hanson	University of Michigan (Professor Emeritus)
FEMA representative	Mai Tong	Federal Emergency Management Agency
NIST representative	Steven McCabe	National Institute of Standards and Technology
NIST representative	Siamak Sattar	National Institute of Standards and Technology
NIBS Staff	Jiqiu (JQ) Yuan	National Institute of Building Sciences

PUC Issue Teams

IT 1, Seismic Performance Objectives		
Chair	Robert Pekelnicky	Degenkolb Engineers
Voting Member	Ibbi Amufti	Arup
Voting Member	David Bonneville	Degenkolb Engineers
Voting Member	Julie Furr	Rimkus Consulting Group
Voting Member	Ron Hamburger	Simpson Gumpertz & Heger
Voting Member	Jim Harris	James Harris & Associates
Voting Member	Jon Heintz	Applied Technology Council
Voting Member	John Hooper	Magnusson Klemencic Associates
Voting Member	Steven McCabe	National Institute of Standards and Technology
Voting Member	Maryann Phipps	Estructure
Voting Member	John Silva	Hilti
Voting Member	J. G. (Greg) Soules	CB&I Storage Tank Solutions
Corresponding Member	David Bonowitz	David Bonowitz, S.E.
Corresponding Member	Dan Dolan	Washington State University
Corresponding Member	John Gillengerten	SE, Retired OSHPD
Corresponding Member	Philip Line	American Wood Council
Corresponding Member	Nicolas Luco	U.S. Geological Survey
Corresponding Member	Terry Lundeen	Coughlin Porter Lundeen
Corresponding Member	Kevin Moore	Simpson Gumpertz & Heger
Corresponding Member	Rob Smith	Arup
Corresponding Member	Jeffrey Soulages	Intel Corporation
IT 2, Seismic-Force Resisting Systems and Design Coefficients		
Chair	Conrad "Sandy" Hohener	Degenkolb Engineers
Voting Member	Dan Dolan	Washington State University
Voting Member	Edwin Huston	Smith & Huston
Voting Member	Bret Lizundia	Rutherford + Chekene
Voting Member	Kevin Moore	Simpson Gumpertz & Heger
Voting Member	Tom Xia	DCI Engineers
Corresponding Member	Richard Bennett	University of Tennessee
Corresponding Member	Hussain Bhatia	OSHPD
Corresponding Member	Bonnie Manley	Steel Market Develop Insitute
Corresponding Member	Dan Sloat	Degenkolb Engineers
Corresponding Member	J. G. (Greg) Soules	CB&I Storage Tank Solutions
Corresponding Member	Taka Tamiya	Degenkolb Engineers
Corresponding Member	Robert Tremblay	Polytechnique

IT 3, Modal Response Spectrum Analysis Considerations		
Chair	Anindya Dutta	Simpson Gumpertz & Heger
Voting Member	Kevin Aswegan	Magnusson Klemencic Associates
Voting Member	Robert Hanson	University of Michigan
Voting Member	Jay Harris	National Institute of Standards and Technology
Voting Member	James Malley	Degenkolb Engineers
Voting Member	Rafael Sabelli	Walter P. Moore
Corresponding Member	Jason Collins	PCS Structural Solutions
Corresponding Member	Finley Charney	Virginia Tech
Corresponding Member	Rob Tovani	Computers and Structures,
IT 4, Shear Wall Design		
Chair	S.K. Ghosh	S. K. Ghosh Associates
Voting Member	Dick Bennett	University of Tennessee
Voting Member	Michel Bruneau	University of Buffalo
Voting Member	Kelly Cobeen	Wiss, Janney, Elstner Associates
Voting Member	Jason Collins	PCS Structural Solutions
Voting Member	David Fields	Magnusson Klemencic Associates
Voting Member	Gino Kurama	University of Notre Dame
Voting Member	Andy Taylor	KPF Consulting Engineers
Corresponding Member	Kevin Aswegan	Magnusson Klemencic Associates
Corresponding Member	Jeff Berman	University of Washington
Corresponding Member	Daniel Borello	Oregon State University
Corresponding Member	Dan Dolan	Washington State University
Corresponding Member	Anindya Dutta	Simpson Gumpertz & Heger
Corresponding Member	Larry Fahnestock	University of Illinois at Urbana-Champaign
Corresponding Member	Joe Ferzli	Cary Kopczynski & Company
Corresponding Member	John Hooper	Magnusson Klemencic Associates
Corresponding Member	Dawn Lehman	University of Washington
Corresponding Member	Philip Line	American Wood Council
Corresponding Member	Bonnie Manley	American Iron and Steel Institute
Corresponding Member	Joe Maffei	Maffei Structural Engineering
Corresponding Member	Jack Moehle	University of California Berkeley
Corresponding Member	Lawrence Novak	Portland Cement Association
Corresponding Member	Laura Lowes	University of Washington
Corresponding Member	Jose Restrepo	University of California, San Diego
Corresponding Member	Rafael Sabelli	Walter P. Moore
Corresponding Member	Siamak Sattar	National Institute of Standards and Technology
Corresponding Member	Amit Varma	Purdue University
Corresponding Member	John Wallace	University of California, Los Angeles
Corresponding Member	Andrew Whittaker	University of Buffalo
Corresponding Member	Tom Xia	DCI Engineers
Corresponding Member	Kirsten Zeydel	ZO Consulting

IT 5, Nonstructural Components		
Chair	John Gillengerten	SE, Retired OSHPD
Voting Member	Peter Carrato	Bechtel Power Corporation
Voting Member	Travis Churpalo	Degenkolb Engineers
Voting Member	William Holmes	Rutherford + Chekene
Voting Member	Bret Lizundia	Rutherford + Chekene
Voting Member	John Silva	Hilti
Voting Member	J. G. (Greg) Soules	CB&I Storage Tank Solutions
Voting Member	Chris Tokas	OSHPD
Corresponding Member	Hussain Bhatia	OSHPD
Corresponding Member	Phil Caldwell	Schneider
Corresponding Member	Meaghan Halligan	ISAT
Corresponding Member	Matthew Hoehler	National Institute of Standards and Technology
Corresponding Member	Robert Pekelnicky	Degenkolb Engineers
Corresponding Member	Maryann Phipps	Estructure
Corresponding Member	Robert Simmons	Petra Seismic Design
Corresponding Member	Siavash Soroushian	Arup
IT 6, Nonbuilding Structures		
Chair	Peter Carrato	Bechtel Power Corporation
Voting Member	J. G. (Greg) Soules	CB&I Storage Tank Solutions
Voting Member	Bill Scott	AISC Industrial building committee
Voting Member	Eric Wey	Fluor
Corresponding Member	Rick Drake	Fluor
Corresponding Member	John Rolfes	Computerized Structural Design
Corresponding Member	Robert Simmons	Petra Seismic / ASHRAE
Corresponding Member	John Silva	Hilti
Corresponding Member	Harold Sprague	Parsons
IT 7, Soil-Foundation Interaction		
Chair	Stephen Harris	Simpson Gumpertz & Heger
Voting Member	C.B. Crouse	AECOM
Voting Member	Gyimah Kasali	Rutherford + Chekene
Voting Member	Ian McFarlane	Magnusson Klemencic Associates
Voting Member	Robert Pekelnicky	Degenkolb Engineers
Voting Member	Jonathan Stewart	University of California, Los Angeles
Corresponding Member	Bruce Kutter	University of California Davis
Corresponding Member	Armin Masroor	Arup

IT 8, Base Isolation and Energy Dissipation		
Deactivated		
IT 9, Diaphragm Issues - RWFD and Alternate Provisions for Diaphragm Design		
Chair	Kelly Cobeen	Wiss, Janney, Elstner Associates
Voting Member	John Lawson	Cal Poly San Luis Obispo
Voting Member	S.K. Ghosh	S. K. Ghosh Associates
Voting Member	Ron La Plante	California Division of the State Arch
Voting Member	Ben Schafer	Johns Hopkins University
Voting Member	Tom Sabol	Engelkirk & Sabol
Corresponding Member	Pouria Bahmani	KPFF Consulting Engineers
Corresponding Member	Patrick Bodwell	Vulcraft/ Verco Group
Corresponding Member	Dan Dolan	Washington State Universtiy
Corresponding Member	Matt Eatherton	Virginia Tech
Corresponding Member	Andre Filiatrault	SUNY University at Buffalo
Corresponding Member	Christopher Gill	Hilti North America
Corresponding Member	Dave Golden	ASC Steel Deck Div. of ASC Profiles
Corresponding Member	Jerome (Jerry) Hajjar	Northeastern University
Corresponding Member	Steve Hobbs	Vulcraft
Corresponding Member	Maria Koliou	Colorado State University
Corresponding Member	William Holmes	Rutherford + Chekene
Corresponding Member	Philip Line	American Wood Council
Corresponding Member	Bonnie Manley	American Iron and Steel Institute
Corresponding Member	Scott Schiff	Applied Technology Council
Corresponding Member	Walt Schultz	Nucor
Corresponding Member	Andrew Shuck	Wiss, Janney, Elstner Associates
Corresponding Member	Robert Tremblay	Polytechnique Montreal
Corresponding Member	Tom Xia	DCI Engineers
IT 10, Seismic Design Value Maps		
Chair	C.B. Crouse	AECOM
Voting Member	Ron Hamburger	Simpson Gumpertz & Heger
Voting Member	Jim Harris	James Harris & Associates
Voting Member	William Holmes	Rutherford + Chekene
Voting Member	John Hooper	Magnusson Klemencic Associates
Voting Member	Charles Kircher	Charles Kircher & Associates
Voting Member	Nicolas Luco	U.S. Geological Survey
Voting Member	Sanaz Razaiean	U.S. Geological Survey
Voting Member	Jonathan Stewart	University of California Los Angeles

Project 17 Work Groups

WG1, Uncertainty and Precision		
Chair	Dan Dolan	Washington State University
Member	Ben Enfield	City of Seattle Building Department
Member	Jon Heintz	Applied Technology Council
Member	Nicolas Luco	U.S. Geological Survey
Member	Robert Pekelnicky	Degenklob Engineers
WG2, Acceptable Risk		
Chair	Robert Pekelnicky	Degenkolb Engineers
Member	Ibbi Amufti	ARUP
Member	Jack Baker	Stanford University
Member	C.B. Crouse	AECOM
Member	Jon Heintz	Applied Technology Council
Member	William Holmes	Rutherford + Chekene
Member	John Hooper	Magnusson Klemencic Associates
Member	Charles Kircher	Charles Kircher & Associates
Member	Nicolas Luco	U.S. Geological Survey
Member	Siamak Sattar	National Institute of Standards and Technology
Member	Jonathan Stewart	University of California, Los Angeles
WG3, Multi-Period Spectral Parameters		
Chair	Charles Kircher	Charles Kircher & Associates
Member	David Bonneville	Degenkolb Engineers
Member	C.B. Crouse	AECOM
Member	John Hooper	Magnusson Klemencic Associates
Member	Nicolas Luco	U.S. Geological Survey
Member	Sanaz Rezaeian	U.S. Geological Survey
Member	Jonathan Stewart	University of California, Los Angeles
WG4, Deterministic Maps		
Chair	C.B. Crouse	AECOM
Member	Ned Field	U.S. Geological Survey
Member	John Hooper	Magnusson Klemencic Associates
Member	Charles Kircher	Charles Kircher & Associates
Member	Nicolas Luco	U.S. Geological Survey
Member	Sanaz Rezaeian	U.S. Geological Survey
Member	Jonathan Stewart	University of California, Los Angeles
WG5, Seismic Design Category		
Chair	Julie Furr	Rimkus Consulting Group
Member	Dan Dolan	Washington State University
Member	Jim Harris	James Harris & Associates
Member	William Holmes	Rutherford + Chekene
Member	John Hooper	Magnusson Klemencic Associates
Member	Robert Pekelnicky	Degenkolb Engineers
Member	Jon Siu	City of Seattle, Washington
Member	Paul Timko	Cromwell Architects Engineers

Project 17 Planning and Advisory Committees

Project 17 Planning Committee Participants		
Chair	Ronald Hamburger	Simpson Gumpertz & Heger Inc.
Member	David Bonneville	Degenkolb Engineers
Member	C.B. Crouse	AECOM
Member	Edward Field	U.S. Geological Survey
Member	Arthur Frankel	U.S. Geological Survey
Member	Robert Hanson	University of Michigan (Emeritus)
Member	James Harris	James Harris & Associates
Member	William Holmes	Rutherford & Chekene
Member	John Hooper	Magnusson Klemencic Associates
Member	Charles Kircher	Kircher & Associates
Member	Nicolas Luco	U.S. Geological Survey
Member	Morgan Moschetti	U.S. Geological Survey
Member	Robert Pekelnicky	Degenkolb Engineers
Member	Mark Petersen	U.S. Geological Survey
Member	Peter Powers	U.S. Geological Survey
Member	Sanaz Rezaeian	U.S. Geological Survey
Member	Philip Schneider	Building Seismic Safety Council
Member	Mai Tong	Federal Emergency Management Agency
Project 17 Advisory Committee		
Chair	Jennifer Goupil	American Society of Civil Engineers
Member	Philip Caldwell	Schneider Electric
Member	John Egan	Consulting Engineer
Member	Gary Ehrlich	National Association of Home Builders
Member	Kevin Moore	Simpson Gumpertz & Heger
Member	Mike Mota	Concrete Reinforcing Steel Institute
Member	Adrian Rodrigues-Merak	Virginia Tech
Member	J. G. (Greg) Soules	CB&I Storage Tank Solutions
Member	Zia Zafir	Kleinfelder

Project Management

Project Management		
FEMA Project Manager	Mai Tong	Federal Emergency Management Agency
PUC Chair	David Bonneville	Degenkolb Engineers
NIBS Project Manager	Jiqiu (JQ) Yuan	National Institute of Building Sciences
NIBS Project Manager	Philip Schneider ¹	National Institute of Building Sciences

¹ Year 2015-2019

BSSC Board of Direction

2018-2019 Board of Direction		
Chair	James Cagley	Cagley & Associates
Vice Chair	Charlie Carter	American Institute of Steel Construction
Secretary	Jennifer Goupil	American Society of Civil Engineers
At-Large	Bahram Zarin-afsar	Zarin-afsar & Associates
At-Large	Mike Pfeiffer	International Code Council
NIBS Board Liaison	Anne Ellis	Anne Ellis, LLC
2017-2018 Board of Direction		
Chair	James Cagley	Cagley & Associates
Vice Chair	Charlie Carter	American Institute of Steel Construction
Secretary	Jennifer Goupil	American Society of Civil Engineers
At-Large	Bahram Zarin-afsar	Zarin-afsar & Associates
NIBS Board Liaison	Anne Ellis	Anne Ellis, LLC
2016-2017 Board of Direction		
Chair	Jim Sealy	FAIA, Dallas, TX
Vice Chair	James Cagley	Cagley & Associates
Secretary	Susan Dowty	International Code Council
At-Large	Charlie Carter	American Institute of Steel Construction
At-Large	Jennifer Goupil	American Society of Civil Engineers
NIBS Board Liaison	Anne Ellis	Anne Ellis, LLC
2015-2016 Board of Direction		
Chair	Jim Sealy	FAIA, Dallas, TX
Vice Chair	James Cagley	Cagley & Associates
Secretary	Melvyn Green	Melvyn Green & Associates
Members	Remington Brown	Insurance Institute for Building and Home Safety
	Charles Carter	American Institute of Steel Construction
	Bradford Douglas	Engineering American Wood
	Jennifer Goupil	American Society of Civil Engineers
	Perry Haviland	FAIA, Oakland, CA
	John Hayes	NIST, NEHRP Director
	Jay Larson	American Iron and Steel Institute
	Ron Lynn	Clark County Government Center, Las Vegas, NV
	Greg Schindler	KPFF Consulting Engineers
	Matthew Senecal	American Concrete Institute
	Stephen Szoke	Portland Cement Association
Jason Thompson	National Concrete Masonry Association	

BSSC Member Organizations

Organization	Representative
American Concrete Institute	Khaled Nahlawi
American Institute of Architects	Perry Haviland
American Institute of Steel Construction	Larry Kruth
American Iron and Steel Institute	Bonnie Manley
American Society of Civil Engineers	Jennifer Goupil
American Wood Council	Bradford Douglas
The Engineered Wood Association	Thomas Skaggs
Applied Technology Council	Jim Cagley
ASHRAE	Robert Simmons
Building Owners and Managers Association	John Catlett
California Department of General Services	Diane Gould
Concrete Masonry Association of California and Nevada	Kurt Siggard
Concrete Reinforcing Steel Institute	Danielle Kleinhans
Concrete Reinforcing Steel Institute	David Fanella
Department of Veterans Affairs	Juan Archilla
General Services Administration	William Earl
Insurance Institute for Business and Home Safety ¹	Anne Cope
International Code Council	Mike Pfeiffer
Metal Building Manufacturers Association	Lee Shoemaker
National Association of Homebuilders	Gary Ehrlich
National Concrete Masonry Association	Jason Thompson
National Council of Structural Engineers Associations	Kevin Moore
Portland Cement Association	Paul Tennis
Precast/Prestressed Concrete Institute	Roger Becker
Rack Manufacturers Institute	Victor Azzi
Steel Deck Institute	Robert Paul
Structural Engineer Association of Washington	Patrick Lindblom
Structural Engineers Association of California	Don Schinske
Structural Engineers Association of Central California	David Palmer
Structural Engineers Association of Colorado ²	Rob Jackson
Structural Engineers Association of Illinois	Jon Sfura
Structural Engineers Association of Kansas & Missouri	F. Alan Wiley
Structural Engineers Association of Northern California	Ken Miles
Structural Engineers Association of Oregon ³	Reid Zimmerman
Structural Engineers Association of San Diego	Heather Caya
Structural Engineers Association of Southern California	Dianne Ochoa
Structural Engineers Association of Utah	Philip Miller
Steel Joist Institute	Kenneth Charles
The Masonry Society	Philip Samblanet

Note: 1. membership 2017-2018. 2. membership 2018-2020. 3. membership 2019-2020.